

# **Reactive Extraction of Oxygenates with Aqueous Salt Solutions**

**Boris Kuzmanović**

**Graduation committee:**

|                       |                                |  |
|-----------------------|--------------------------------|--|
| Chairman:             | Prof. dr. C. Hoede             | University of Twente                   |
| Promotor:             | Prof. dr. ir. A.B. de Haan     | University of Twente                   |
| Assistant promotor:   | Dr. ir. N.J.M. Kuipers         | University of Twente                   |
| Academic members:     | Prof. dipl.-ing. dr. H.J. Bart | Technical University of Kaiserslautern |
|                       | Prof. dr. ir. J.F.J. Engbersen | University of Twente                   |
|                       | Prof. dr. ir. H. van den Berg  | University of Twente                   |
|                       | Prof. dr. ir. P.J. Jansens     | Delft University of Technology         |
| Expert from industry: | Dr. ir. G. Kwant               | DSM Research                           |

The research described in this thesis was carried out in the Separation Technology Group at the University of Twente in cooperation with DSM Research. The research is financially supported by DSM, the Dutch Organisation for Scientific Research (NWO) and the Dutch Agency for Energy and Environment (NOVEM).

Reactive extraction of oxygenates with aqueous salt solutions

B. Kuzmanović

ISBN 90-365-1987-X

Cover: Developed automated workstation for liquid-liquid equilibrium measurements.

Copyright © 2003 by B. Kuzmanović

All rights reserved.

Printed by Febodruk BV, Enschede, The Netherlands.

# REACTIVE EXTRACTION OF OXYGENATES WITH AQUEOUS SALT SOLUTIONS

DISSERTATION

to obtain  
the doctor's degree at the University of Twente,  
on the authority of the rector magnificus,  
prof. dr. F.A. van Vught,  
on account of the decision of the graduation committee,  
to be publicly defended  
on Wednesday 10<sup>th</sup> December 2003 at 15.00 hrs

by

**Boris Kuzmanović**

born on 23<sup>rd</sup> December 1973

in Sarajevo, Yugoslavia

The dissertation is approved by the promotor prof. dr. ir. A.B. de Haan and the assistant  
promotor dr. ir. N.J.M. Kuipers.

# Foreword

Although different separation technologies are known and applied in chemical industrial practice, each of them suffers from certain drawbacks. For example, it is energy demanding, sensitive to the presence of contaminants in the feed, or not suitable for large-scale continuous processes. Therefore, we are in a constant search for better separation techniques. They should provide better separation of mixtures with minimal consumption of energy, utilities or chemicals, with no risk for humans and the environment and should be applicable in a large-scale process. A small contribution towards that goal is attempted by the research presented in this book. A new option, that could offer a significant reduction in energy consumption of the conventional separations in the several existing chemical industrial processes, is proposed and, during the last four years, explored. Although not all attempts resulted in feasible separation options and even those feasible are still far away from any direct application, the principle of the proposed technology has been proven and the potential of such option is demonstrated in this research. I am proud that I was involved in such explorative research that could make a step forward in the field.

Although this book represents my dissertation, the accomplished work could not be done without many people to whom I want to thank here.

First of all, the drawbacks of one of the mentioned industrial processes and the basis for the proposed separation technique are brought up by professor André de Haan. He presented it to me four years ago and gave me the opportunity to work on this subject. During all those four years, from the very beginning of the project to the completion of this thesis, both my mentors, professor André de Haan and assistant professor Norbert Kuipers, always had time to talk with me and advise me about any issue that was important at that moment. No matter where and how long was needed for such a discussion, they were always there. Many, many hours of fruitful discussions with André and Norbert had enormous value to me. They provided advice and encouragement when new ideas were explored. That was not only valuable for completing this research, but will be of use also in my future career. Equally important are their comments on the presentations for conferences, scientific papers and especially this thesis, which resulted in a significant improvement in scientific quality and readability.

Regular contact and meetings with the experts from DSM Research ensured that the research stays in constant touch with industry. I thank them, and especially dr. Gerard Kwant, for all their useful comments and suggestions.

Without the help of Bert, Henny, Alfons, Henk-Jan and Annemarie the experimental part of the research could not be carried out. Their ideas, advice and practical help in developing experimental set-ups and analytical methods were essential. To Marga, Rimon, Kimmo, Katarina, Tessa and Gianluca I want to thank for their participation in different parts of this research. To Wim Brilman I owe many thanks for his suggestions and the help in making an experimental set-up for the carboxylic acid extraction experiments. Also, I want to thank to Ronald ter Hart from Varian and Geert Alkema from Atas for their help during the development of the automated workstation for the liquid-liquid equilibrium experiments.

I am really grateful to all my colleagues in the Separation Technology Group. Some of them were directly involved in this research and some not. However, they all contributed to

it by their comments and opinions, but above all for being great colleagues. It was really a pleasure being a part of the family!

By completing and defending this thesis my official engagement with University of Twente has ended. However, the contact with the people I met during these years will definitively remain. I had a chance to meet people coming from different parts of the Netherlands, from different parts of the World and even from the same country I am from. I learned a lot from them and many became my very good friends. I want to thank them all, since without them, this period wouldn't be as good as it was.

My family's contribution is priceless. In the first place, Jelena, my parents and my sister, but also all my family from Belgrade, Sarajevo, Zaječar, Hoogeveen and Groningen, followed the course of my research and suggested how to solve the problems or how to proceed on many crossroads which appeared during this time. However, the love, support and understanding I had from all of them is that what was much more important. Without them I wouldn't be here where I am.

Finally, I would like to thank to my professors and colleagues at the University of Belgrade for their guidance and support during the past 10 years.

# Summary

## Introduction

Medium- and high-molecular-weight oxygenates are often present in less than 10 wt% concentrations in apolar organic solvents from which they need to be recovered. The majority of existing industrial processes in which those oxygenates are produced use distillation for their recovery from the organic solvent. The solvent has generally a lower boiling point than the oxygenates, and therefore needs to be evaporated if the separation is achieved by distillation. Hence, the energy consumption in such processes is very high and a recovery technique, which will eliminate evaporation of the solvent without the need for large equipment and numerous unit operations, is required.

This thesis proposes and evaluates reactive extraction, which uses aqueous salt solutions as reactive solvents. Because water is already present in generally any oxygenate production process, its involvement would not cause contamination of the system. Water is practically immiscible with any apolar organic solvent and it is preferable from environmental and safety points of view. To overcome the poor extraction capacity of pure water, the introduction of environmentally and toxicologically benign salts in water is considered. The distribution ratio of the oxygenate between the aqueous and apolar organic phase would significantly increase if the added salt could selectively react with the oxygenate, modifying it into a charged compound. Naturally, this interaction has to be reversible to be able to regenerate this chemically extracted oxygenate.

## Objective

The objective of the research presented in this thesis is to explore the feasibility of using aqueous salt solutions as reactive extraction solvents for the recovery of three important classes of oxygenates - carbonyl compounds, carboxylic acids and alcohols - from a dilute apolar organic solution. For the recovery to be feasible, an aqueous salt solution is required to exhibit a sufficiently high capacity and selectivity towards the oxygenate, and to allow an efficient back-recovery of the chemically extracted oxygenate, preferably by applying a simple technique such as a temperature shift or a pH shift.

## Reactive extraction of carbonyl compounds

Several aqueous salt solutions are evaluated as reactive extraction solvents for the recovery of aldehydes and ketones. The influence of the type (amino, hydrazine, or hydrogen sulphite) and structure of the salt on the extraction performance toward aromatic and linear aliphatic aldehydes, as well as toward cycloaliphatic and linear aliphatic ketones was analysed. The results show that some of these aqueous salt solutions enable distribution ratios toward carbonyl as high as 300, which are orders of magnitude higher than the values obtained by most conventional solvents. It is found that aqueous solutions of hydrogen sulphite or a hydrazine salt have much higher capacities than solutions of amine salts. Furthermore, the presence of a carboxylic group in the salt instead of a sulfonic group, but also a larger distance of the acidic group from the reacting amino center, improves the extraction capacity of an amine extractant. Generally, it was noticed that the extractability using aqueous salt solutions decreases in the order: linear aldehyde > aromatic aldehyde > cyclic ketone > linear

ketone. The losses of organic solvent in the extract or water in the raffinate are not significantly influenced by the presence of salt, thereby providing a high selectivity toward carbonyls relative to the apolar organic solvent.

Most of the evaluated salt solutions showed a decrease in the carbonyl distribution ratio with increasing temperature, indicating that a temperature shift might be a feasible option for the back-recovery of the carbonyl. Therefore, by providing a high capacity and high selectivity, and by enabling back-recovery by a simple temperature shift, aqueous salt solutions show sufficient potential to be used as reactive extraction solvents for the recovery of carbonyl compounds from apolar organic solvents.

### **Reactive extraction of carboxylic acids**

A combination of using an aqueous solution of sodium hydrogen carbonate for the forward-extraction, and carbon dioxide under pressure for the back-recovery of a carboxylic acid from a dilute apolar organic solutions is studied. Used as combination, these two steps might provide a technique for the recovery of a carboxylic acid from an organic solution in which no formation of by-products (inorganic salts) occurs and only environmentally benign chemicals are used. Results show that the aqueous solution of sodium hydrogen carbonate provides distribution ratios for several aromatic and aliphatic acids as high as 200, whereas the solubility of the organic solvent in the aqueous solution remains unchanged relative to pure water, enabling also high selectivity.

Two options for the back-recovery of the extracted acids based on the use of CO<sub>2</sub> under pressure are evaluated: by new phase (liquid or solid) formation or by back-extraction. Equilibrium stage recoveries of around 50% are obtained in both cases. That recovery can be improved by addition of a salting-out agent in the aqueous phase. In that case recoveries of up to 90 % are achieved, where a recovery of 50% is already reached at a pressure of 5 bar. Therefore, both forward-extraction using an aqueous solution of sodium hydrogen carbonate and back-recovery by carbon dioxide under pressure are technically feasible options and could be combined for the recovery of carboxylic acids from an apolar organic solvent.

### **Reactive extraction of alcohols**

Two approaches of applying reactive extraction for the recovery of monohydroxyl alcohols from an apolar organic solvent are evaluated. The first, in which an aqueous solution containing a reactive extractant was applied for the recovery of unmodified alcohol, shows limited potential to be used. Among several evaluated extractants only some were able to achieve a slight improvement of the distribution ratio of alcohol relative to pure water to a maximum value of 2.7. Besides moderate distribution ratios of an alcohol, these extractants are also found to increase the solubility of the apolar organic solvent in the aqueous phase and thereby cause a decrease in selectivity toward the alcohol.

The second considered approach, in which the alcohol is chemically modified prior to the extraction into an easy-extractable form, in this case a monoester, has much more potential. A benign solvent, like an aqueous solution of sodium hydrogen carbonate, can provide a distribution ratio of benzyl alcohol up to 200, leaving the solubility of the organic solvent in the aqueous solutions unchanged relative to pure water. The modification of alcohols can be done efficiently in an apolar organic solvent with no need for a catalyst. It is found that the back-recovery of in-this-way extracted alcohol can be performed by back-extraction in combination with a spontaneous hydrolysis. The rate of hydrolysis can be efficiently controlled by temperature. Hence, an efficient and selective recovery of alcohols can be



achieved by reactive extraction using aqueous salt solutions by modifying the alcohol into a monoester prior to the extraction.

### **Conceptual process design for oxygenate recovery based on reactive extraction**

Based on the results of the conducted research on the reactive extraction of the three different classes of oxygenates, an optimal reactive-extraction-based process is established at the conceptual level for the recovery of benzyl alcohol, benzaldehyde and benzoic acid from a dilute toluene solution. The processes in which all three products are simultaneously extracted appeared to be the most attractive based on the fewest number of unit operations needed. By evaluating the operational costs, it is concluded that the process which involves reactive extraction of modified alcohol seems to be the most attractive.

When this process is compared with an adequate distillation-based process for the same separation, it is observed that a significant reduction in the operational costs may be achieved by using reactive extraction instead of distillation. The savings depend on the concentration of oxygenates in the organic feed and appeared to be between 85 and 40% for product concentration between 1 and 5 wt%. As their concentration increases, the advantage of the reactive extraction process reduces. It is estimated that above 8 wt%, the reactive extraction process does not offer any operational cost advantage relative to the distillation process. As an illustration, for a typical production rate of 90000 t/a and at 5% toluene conversion, the mentioned annual reduction in operational costs would reach 1.9 M€/a, providing 5.7 M€ room for additional capital investments compared to a distillation-based process (with a pay-back time of 3 years). An additional 20% increase in the operational cost savings is expected to be possible by replacing the back-extraction of benzyl alcohol and benzaldehyde with the back-recovery by new phase formation.

### **Feasibility of performing reactive extraction in typical extraction equipment**

As a feasibility study, a reactive extraction of benzaldehyde is performed in a pilot plant pulsed disc and doughnut column using an aqueous solution of sodium hydrogen sulphite as the reactive extraction solvent. A very efficient extraction is achieved as the recovery is found to be higher than 99.9% in a column of 4 m in height and 4.0 cm in diameter, applying solvent-to-feed ratio of 2 and higher. Therefore, it is proven that proposed reactive extraction can be efficiently performed in a typical extraction setup.

### **Fully automated workstation for liquid-liquid equilibrium measurements**

A fully automated workstation has been developed and applied for the measurement of liquid-liquid equilibrium data. The measurements, that start from solution preparations through equilibrium establishment and chemical analysis and end with the determined solute concentration in both phases, can be performed on a 24 h per day basis, enabling 36 equilibrium experiments per day without any human intervention. The accuracy of measurements on this workstation is evaluated by measuring distribution ratios in several well-characterised two-phase systems, for which the obtained results are in very good agreement with the values reported in the literature. The determined coefficient of variation for repeated measurements amounted 1.8%, demonstrating that a satisfying repeatability can also be achieved.



# Samenvatting

## Inleiding

Oxygenates (zuurstofbevattende koolwaterstoffen) van medium- en hoogmoleculair gewicht dienen als gewenst product verwijderd te worden uit apolaire organische oplossingen waarin ze vaak aanwezig zijn in concentraties lager dan 10 gewichtsprocent. Het grootste deel van de bestaande industriële productieprocessen voor deze oxygenates maakt hierbij gebruik van distillatie. In het algemeen heeft het oplosmiddel echter een lager kookpunt dan de oxygenates, zodat eerst het oplosmiddel dient te worden verdampt. Daarom is het energieverbruik in deze processen zeer hoog en is het aantrekkelijk om te kijken naar een alternatieve scheidingstechniek waarin het oplosmiddel niet verdampt hoeft te worden zonder dat hiervoor veel en grote apparaten nodig zijn.

In dit proefschrift wordt daarom reactieve extractie als alternatieve scheidingstechniek voorgesteld en geëvalueerd, waarbij waterige zoutoplossingen worden gebruikt als reactieve oplosmiddelen. Omdat water reeds aanwezig is in elk productieproces van een oxygenate, zal het systeem niet vervuild worden door de introductie van deze stof. Bovendien is water praktisch onoplosbaar in ieder apolair organisch oplosmiddel en verdient het tevens de voorkeur vanuit milieu- en veiligheidsoverwegingen. Om de beperkte extractiecapaciteit van zuiver water te overwinnen, worden milieuvriendelijke oplosbare zouten aan het water toegevoegd. De verdelingscoëfficiënt van zo'n oxygenate tussen de waterige fase en de apolaire organische fase kan significant toenemen als het toegevoegde zout in staat is selectief met het oxygenate te reageren tot een geladen product. Natuurlijk moet deze interactie reversibel zijn om deze chemisch geëxtraheerde oxygenate te kunnen terugwinnen.

## Doel

Het doel van het onderzoek dat in dit proefschrift wordt beschreven, is om de haalbaarheid te bepalen van het gebruik van waterige zoutoplossingen als oplosmiddelen voor de reactieve extractie uit een verdunde oplossing met een apolair organisch oplosmiddel van drie belangrijke klassen van oxygenates, te weten carbonylverbindingen, carbonzuren en alcoholen. Om dit technisch te kunnen realiseren, is een waterige zoutoplossing vereist die een voldoende hoge capaciteit en selectiviteit vertoont voor het desbetreffende oxygenate waarbij bovendien een efficiënte terugwinning van het chemisch geëxtraheerde oxygenate mogelijk is, bij voorkeur door een eenvoudige techniek als een verandering in temperatuur of pH.

## Reactieve extractie van carbonylverbindingen

Verschillende waterige zoutoplossingen zijn onderzocht als oplosmiddelen voor reactieve extractie van aldehyden en ketonen. De invloed van het type zout (amine, hydrazine, bisulfiet) en de structuur van het zout zijn onderzocht op het extractiegedrag van aromatische en lineair-alifatische aldehyden alsmede cyclische- en lineair-alifatische ketonen. De resultaten laten zien dat hoge verdelingscoëfficiënten van wel 300 mogelijk zijn voor sommige waterige zoutoplossingen. Deze liggen ordes van grootte hoger dan de waarden die verkregen worden door toepassing van de meeste conventionele oplosmiddelen. Bisulfiet en hydrazine zoutoplossingen geven veel hogere capaciteiten dan oplossingen van aminezouten. Bovendien kan de extractiecapaciteit van een amine-extractant worden vergroot door een

sulfonzuurgroep te vervangen door een carbonzuurgroep en door een grotere afstand tussen de zuurgroep en de reagerende aminogroep. In het algemeen is gevonden dat de extractiecapaciteit van waterige zoutoplossingen afneemt in de volgorde: lineair aldehyde > aromatisch aldehyde > cyclisch keton > lineair keton. De oplosbaarheid van het organisch oplosmiddel in het extract, of water in het raffinaat, wordt niet significant beïnvloed door de aanwezigheid van zout zodat een hoge selectiviteit voor de carbonylverbinding ten opzichte van het apolaire organische oplosmiddel wordt verkregen.

Het merendeel van de geëvalueerde zoutoplossingen laat een afname zien van de verdelingscoëfficiënt van de carbonylverbinding met toenemende temperatuur. Dit impliceert dat een temperatuurverandering een mogelijke optie is voor de terugwinning van zowel zout als carbonyl. Vanwege hun hoge capaciteit en selectiviteit en door de mogelijkheid van terugwinning door een eenvoudige temperatuurverandering, hebben waterige zoutoplossingen voldoende potentie om te worden gebruikt als oplosmiddel voor reactieve extractie van carbonylverbindingen uit apolaire organische oplosmiddelen.

### **Reactieve extractie van carbonzuren**

Er is onderzoek verricht naar een combinatie van het gebruik van een waterige natriumbicarbonaatoplossing voor de extractie van een carbonzuur uit een verdund apolair organische oplossing en vervolgens de toepassing van kooldioxide onder druk voor de terugwinning. In deze combinatie kan een scheidingstechniek worden verkregen voor het verkrijgen van een carbonzuur uit een organische oplossing waarbij geen bijproducten (anorganische zouten) worden gevormd en waarbij alleen milieuvriendelijke chemicaliën worden gebruikt. De resultaten laten zien dat een verdelingscoëfficiënt van 200 kan worden verkregen voor verschillende aromatische en alifatische carbonzuren in een waterige natriumbicarbonaatoplossing. De oplosbaarheid van het organische oplosmiddel in de waterige oplossing verandert echter niet ten opzichte van puur water. Dit resulteert in hoge selectiviteiten.

Twee opties zijn onderzocht voor de terugwinning van de geëxtraheerde carbonzuren door toepassing van kooldioxide onder hoge druk: vorming van een nieuwe fase (vloeistof of vaste stof) of terugextractie. In beide gevallen worden opbrengsten van 50% verkregen per evenwichtstrap. Deze terugwinning kan nog worden verbeterd door de toevoeging van een uitzoutpromotor aan de waterfase. Dan zijn zelfs opbrengsten van 90% haalbaar, terwijl slechts 5 bar kooldioxide nodig is voor een opbrengst van 50%. Daarom zijn zowel de extractie met een waterige natriumbicarbonaatoplossing en de terugwinning met hoge-druk-kooldioxide technisch haalbare opties die gecombineerd kunnen worden voor de terugwinning van carbonzuren uit organische oplosmiddelen.

### **Reactieve extractie van alcoholen**

Er zijn twee methodes gehanteerd bij het toepassen van reactieve extractie voor de winning van mono-alcoholen uit een apolair organisch oplosmiddel. De eerste manier, waarin een waterige oplossing met een reactieve extractant wordt gebruikt voor de winning van een niet-gemodificeerde alcohol, heeft echter niet veel potentie om te worden toegepast. Slechts enkele van de geteste extractanten vertonen een lichte verhoging van de verdelingscoëfficiënt van een alcohol ten opzichte van zuiver water met een maximum waarde van 2.7. Naast deze beperkte verhoging van de verdelingscoëfficiënt, neemt ook de oplosbaarheid van het apolaire organische oplosmiddel in de waterfase toe door deze extractanten zodat de selectiviteit voor het alcohol juist afneemt.

De tweede methode heeft veel meer potentie en is gebaseerd op een chemische modificatie van het alcohol in een gemakkelijk extraheerbare stof, in dit geval een mono-ester, voorafgaand aan de eigenlijke extractie. Toepassing van een milieuvriendelijk oplosmiddel zoals een waterige oplossing van natriumbicarbonaat geeft verdelingscoëfficiënten van benzylalcohol tot 200, zonder dat de oplosbaarheid van het organische oplosmiddel in de waterige oplossing verandert t.o.v. zuiver water. Deze alcoholmodificatie kan effectief in een apolair organisch oplosmiddel worden uitgevoerd zonder dat een katalysator nodig is. De terugwinning van het op deze manier geëxtraheerde alcohol kan worden gerealiseerd door terugextractie in combinatie met een spontane hydrolyse. De snelheid van deze hydrolysereactie kan goed geregeld worden door middel van de temperatuur. Een efficiënte en selectieve winning van alcoholen kan dus worden bereikt door reactieve extractie met waterige zoutoplossingen door voorafgaande aan deze extractie het alcohol te modificeren in een mono-ester.

### **Conceptueel procesontwerp voor oxygenatewinning door reactieve extractie**

Gebaseerd op de onderzoeksresultaten voor de reactieve extractie van de drie verschillende klassen van oxygenaten, is een conceptueel ontwerp gemaakt van een optimaal reactief extractieproces voor de winning van benzylalcohol, benzaldehyde en benzoëzuur uit een verdunde toluleenoplossing. De processen waarbij alle drie producten tegelijkertijd worden geëxtraheerd zijn het meest attractief omdat deze het kleinste aantal eenheidsbewerkingen vereisen. Vanuit het oogpunt van operationele kosten wordt geconcludeerd dat reactieve extractie van het gemodificeerde alcohol het meest attractief is.

Vergelijking van dit optimale reactieve extractieproces met een adequaat distillatieproces laat zien dat een significante reductie in operationele kosten kan worden gerealiseerd door toepassen van reactieve extractie. De besparingen zijn afhankelijk van de concentratie van oxygenates in de organische voeding en liggen tussen 85 en 40% voor productconcentraties tussen 1 en 5 gewichtsprocent. Het voordeel van reactieve extractie wordt kleiner bij toenemende productconcentratie. Bij productconcentraties boven 8 gewichtsprocent geldt bij benadering dat reactieve extractie geen voordeel biedt ten opzichte van distillatie qua operationele kosten. Als een illustratie mag gelden dat voor een typische productiecapaciteit van 90.000 ton/jaar en bij een toluleenconversie van 5%, de jaarlijkse reductie in operationele kosten kan oplopen tot circa 1.9 M€/jaar, hetgeen ruimte biedt voor additionele investeringen van 5.7 M€ ten opzichte van het distillatieproces (bij aanname van een terugbetaaltijd van 3 jaar). Een additionele besparing in operationele kosten van 20% lijkt mogelijk door de terugextractie van benzylalcohol en benzaldehyde te vervangen door terugwinning middels vorming van een nieuwe fase.

### **Haalbaarheid van reactieve extractie in typische extractie-apparatuur**

Als haalbaarheidsstudie is op pilotplantschaal een reactieve extractie uitgevoerd van benzaldehyde in een gepulseerde disc-en-doughnutkolom met een waterige oplossing van natriumbisulfiet als het reactieve oplosmiddel. Deze blijkt zeer effectief te zijn omdat meer dan 99.9% geëxtraheerd wordt in een kolom van 4 m hoogte en 4 cm diameter, terwijl zonder zouttoevoeging nagenoeg geen extractie wordt gevonden. Daarmee is dus bewezen dat de voorgestelde reactieve extractie efficiënt kan worden uitgevoerd in een typische extractie-opstelling.

## **Volledig geautomatiseerd werkstation voor vloeistof-vloeistof evenwichtsmetingen**

Een volledig geautomatiseerd werkstation is ontwikkeld en toegepast voor het meten van vloeistof-vloeistof evenwichten. Een bepaling begint met de bereiding van startoplossingen en eindigt met de chemische analyse van beide fasen. Op die manier kan 24 uur per dag gemeten worden. Daardoor kunnen 36 evenwichtsbepalingen per etmaal gedaan worden zonder menselijke tussenkomst. De nauwkeurigheid van deze bepalingen op het werkstation is onderzocht door het meten van verdelingscoëfficiënten voor verschillende welbekende tweefasesystemen. De gevonden resultaten zijn in zeer goede overeenstemming met de literatuurwaarden. De standaardafwijking van 1.8%, bepaald bij herhaling van een aantal experimenten, laat zien dat ook de herhaalbaarheid bevredigend is.

---

# Contents

|   |           |
|---|-----------|
| <b>1 Introduction</b>   | <b>1</b>  |
| 1.1 Aqueous salt solutions as reactive extraction solvents                                | 1         |
| 1.2 Potential field of application of the proposed extraction technique                   | 4         |
| 1.2.1 Liquid-phase toluene oxidation  | 4         |
| 1.2.2 Cyclohexane oxidation   | 5         |
| 1.2.3 Cyclododecanone oxidation   | 6         |
| 1.2.4 Fischer-Tropsch process   | 7         |
| 1.3 Scope and outline of this thesis  | 7         |
| Literature cited  | 9         |
| <b>2 Fully automated workstation for liquid-liquid equilibrium measurements</b>           | <b>11</b> |
| 2.1 Introduction  | 11        |
| 2.2 Workstation for automated measurements  | 13        |
| 2.3 Liquid-liquid equilibrium measurements  | 17        |
| 2.3.1 Chemicals   | 17        |
| 2.3.2 Equilibrium measurements in the jacketed glass cell operated manually               | 17        |
| 2.3.3 Equilibrium experiments on the automated workstation                                | 18        |
| 2.3.4 Chemical analysis   | 19        |
| 2.3.5 Data analysis   | 19        |
| 2.4 Results and discussion  | 19        |
| 2.4.1 Equilibration time  | 19        |
| 2.4.2 Equilibrium results   | 21        |
| 2.5 Conclusions   | 25        |
| Literature cited  | 27        |
| <b>3 Reactive extraction of aldehydes and ketones</b>                                     | <b>29</b> |
| 3.1 Introduction  | 29        |
| 3.2 Chemical reactions for reactive extraction of carbonyls                               | 29        |
| 3.3 Model   | 30        |
| 3.4 Experimental section  | 33        |
| 3.4.1 Chemicals and solution preparation  | 33        |
| 3.4.2 Equilibrium experiments   | 34        |
| 3.4.3 Chemical analysis   | 35        |
| 3.4.4 Data analysis   | 35        |
| 3.5 Results and Discussion  | 35        |
| 3.5.1 Equilibration time  | 35        |
| 3.5.2 Effect of salt type and structure on equilibrium distribution ratio of benzaldehyde | 36        |
| 3.5.3 Effect of type and structure of the carbonyl compound                               | 40        |

---

|   |           |
|---|-----------|
| 3.5.4 Back-extraction by temperature shift  | 43        |
| 3.5.5 Extraction selectivity  | 43        |
| 3.5.6 Effect of salts on water loss   | 47        |
| 3.6 Conclusions   | 47        |
| Literature Cited  | 49        |
| <b>4 Reactive extraction of carboxylic acids</b>                                    | <b>51</b> |
| 4.1 Introduction  | 51        |
| 4.2 Use of gasses under pressure for recovery purposes                              | 54        |
| 4.3 Equilibrium models  | 55        |
| 4.3.1 Carbon dioxide aided back-recovery  | 55        |
| 4.3.2 Carboxylic acid extraction  | 62        |
| 4.4 Experimental section  | 64        |
| 4.4.1 Chemicals   | 64        |
| 4.4.2 Extraction equilibrium measurements   | 64        |
| 4.4.3 Carbon dioxide aided back-recovery measurements                               | 65        |
| 4.4.4 Chemical analysis   | 68        |
| 4.5 Results and Discussion  | 69        |
| 4.5.1 Aqueous sodium hydrogen carbonate solution as dissociation extraction solvent | 69        |
| 4.5.2 Carbon dioxide aided back-recovery by new phase formation                     | 71        |
| 4.5.3 Carbon dioxide aided back-recovery by back-extraction                         | 76        |
| 4.6 Conclusions   | 81        |
| Literature Cited  | 83        |
| <b>5 Reactive extraction of alcohols</b>  | <b>85</b> |
| 5.1 Introduction  | 85        |
| 5.2 Reactive extraction of unmodified alcohol                                       | 86        |
| 5.2.1 Dissociation reaction   | 86        |
| 5.2.2 Reaction with borate  | 88        |
| 5.2.3 Complexation with borate-diol complex   | 89        |
| 5.2.4 Esterification with dicarboxylic acid monosalt                                | 90        |
| 5.2.5 Complexation with cyclodextrins   | 90        |
| 5.2.6 Complexation with transition metal ion  | 91        |
| 5.2.7 Etherification with halosilane or halohydrocarbon                             | 91        |
| 5.3 Reactive extraction of modified alcohol   | 92        |
| 5.3.1 Modification by monoesterification with cyclic anhydride                      | 92        |
| 5.3.2 Dissociation extraction of modified alcohol                                   | 94        |
| 5.3.3 Regeneration and back-recovery of extracted alcohol                           | 96        |
| 5.3.4 Regeneration and back-recovery of cyclic anhydride                            | 97        |
| 5.3.5 Selection of cyclic anhydrides  | 97        |
| 5.3.6 Effects of implementation of alcohol modification in oxidation process        | 99        |



---

|  |            |
|--|------------|
| 5.4 Experimental section   | 99         |
| 5.4.1 Chemicals  | 99         |
| 5.4.2 Reactive extraction of unmodified alcohol  | 99         |
| 5.4.3 Reactive extraction of modified alcohol  | 100        |
| 5.4.4 Chemical analysis  | 102        |
| 5.5 Results and Discussion   | 103        |
| 5.5.1 Reactive extraction of unmodified alcohol  | 103        |
| 5.5.2 Reactive extraction of modified alcohol  | 106        |
| 5.6 Conclusions  | 119        |
| Literature Cited   | 120        |
| <b>6 Conceptual process design for toluene oxidation products recovery</b>                 | <b>123</b> |
| 6.1 Introduction   | 123        |
| 6.2 Applicable options for reactive extraction and back-recovery                           | 124        |
| 6.3 Product recovery by reactive extraction from a single solute solution                  | 125        |
| 6.3.1 Recovery of benzyl alcohol   | 125        |
| 6.3.2 Recovery of benzoic acid   | 125        |
| 6.3.3 Recovery of benzaldehyde   | 127        |
| 6.4 Product recovery by reactive extraction from multicomponent solution                   | 127        |
| 6.4.1 Integrated reactive extraction of toluene oxidation products                         | 129        |
| 6.4.2 Type A processes   | 130        |
| 6.4.3 Type B process   | 132        |
| 6.4.4 Type C process   | 134        |
| 6.4.5 Optimal process type   | 134        |
| 6.5 Distillation based recovery from multicomponent solution                               | 137        |
| 6.6 Comparison of reactive extraction vs. distillation process                             | 138        |
| 6.7 Feasibility of performing proposed reactive extraction in pilot plant extraction setup | 141        |
| 6.7.1 Extraction column characteristics  | 141        |
| 6.7.2 Experimental procedure   | 142        |
| 6.7.3 Results and discussion   | 143        |
| 6.8 Conclusions  | 145        |
| Literature Cited   | 147        |
| <b>7 Conclusions and recommendations</b>   | <b>149</b> |
| 7.1 Extraction capacity of the aqueous salt solutions                                      | 149        |
| 7.2 Selectivity of the aqueous salt solutions toward oxygenates                            | 150        |
| 7.3 Back-recovery after extraction using aqueous salt solutions                            | 150        |
| 7.4 Conceptual process design for oxygenate recovery based on reactive extraction          | 151        |
| 7.5 Feasibility of performing reactive extraction in typical extraction setup              | 151        |
| 7.6 Recommendations for future research  | 151        |
| <b>List of symbols</b>   | <b>153</b> |

---

|   |            |
|---|------------|
| <b>Appendix A1 Model parameters for recovery of carboxylic acids</b>  | <b>157</b> |
| Literature Cited  | 160        |
| <b>Appendix A2 Case study – Energy requirements and associated costs<br/>for recovery process of toluene oxidation products</b> | <b>161</b> |
| A2.1 Design basis   | 161        |
| A2.2 Reference distillation-based process   | 162        |
| A2.3 Reactive extraction based process with monoesterification of benzyl alcohol  | 163        |
| A2.3.1 Monoesterification   | 163        |
| A2.3.2 Reactive extraction  | 166        |
| A2.3.3 Back-extraction with temperature shift   | 166        |
| A2.3.4 Precipitation and filtration   | 166        |
| A2.3.5 Drying   | 167        |
| A2.3.6 Solids separation  | 167        |
| A2.3.7 Anhydride regeneration   | 167        |
| A2.3.7 Distillation   | 168        |
| A2.4 Reactive extraction based process with recovery of unmodified alcohol  | 169        |
| A2.5 Physical parameters  | 172        |
| Literature Cited  | 174        |

## Chapter 1

# Introduction

Medium- and high-molecular-weight oxygenates are often present in less than 10 wt% concentrations in apolar organic solvents from which they need to be recovered. The majority of existing industrial processes in which those oxygenates are produced use distillation for their recovery from the organic solvent. The solvent has generally a lower boiling point than the oxygenates, and therefore needs to be evaporated if the separation is achieved by distillation. If the solvent concentration in the mixture is 95 wt%, this means that around twenty tons of solvent need to be evaporated to obtain just one ton of the oxygenates. Hence, the energy consumption per ton of recovered oxygenates using distillation is very high. On the other side, there are processes in which other separation techniques are employed instead of distillation. Nevertheless, although evaporation is avoided, large equipment and many unit operations are needed due to inefficient separation. This makes them an unattractive alternative for distillation. Therefore, a recovery technique, which will eliminate evaporation of the solvent without the need for large equipment and numerous unit operations, is required.

This work proposes and evaluates a reactive extraction technique which may be able to fulfil those criteria. The attention is focused on the recovery of alcohols, carbonyl compounds (aldehydes and ketones) and carboxylic acids, as the three most frequently encountered types of oxygenates. Therefore, the term oxygenates is used in this thesis to refer to these three species.

In Section 1.1 first the basis of this technique and the reasons for its choice are discussed. To give an impression of the potential range of its industrial application, typical industrial processes on which it can be applied are listed in Section 1.2. However, its applicability is not limited to those but can generally find application in any situation when a low- or a medium-water-soluble alcohol, aldehyde, ketone or carboxylic acid needs to be recovered from an apolar, i.e. low-water soluble, organic solvent, in which it is present in a few-weight-percent concentration. The scope of the work on the evaluation of this technique and the thesis structure are discussed in Section 1.3.

### 1.1 Aqueous salt solutions as reactive extraction solvents

The low concentration of oxygenates in the solvent, as well as the difference in chemical structure between these compounds and the apolar solvent molecule, justify a consideration

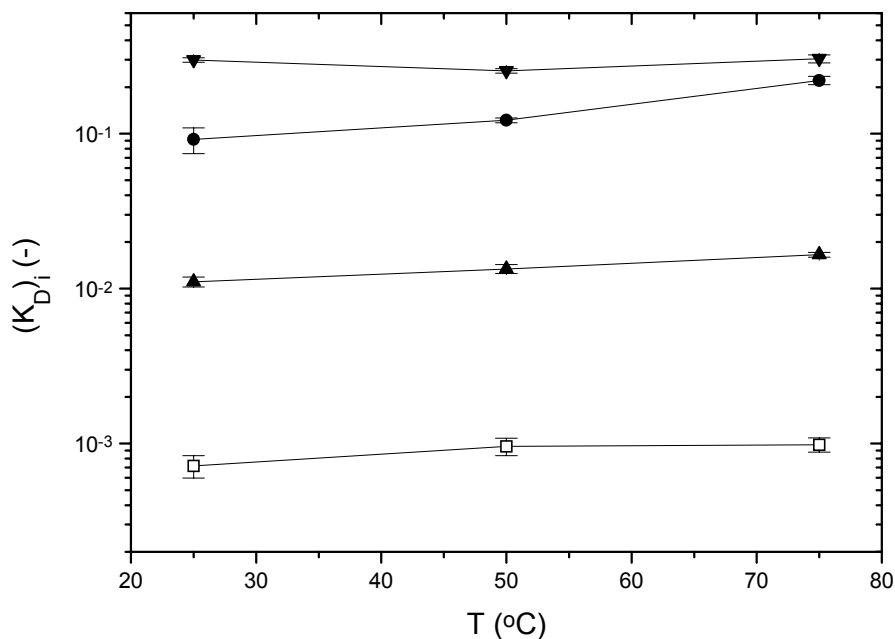
of liquid-liquid extraction for their recovery. However, this asks for an extraction solvent that is immiscible with the apolar organic phase and that is both selective and has a high capacity (distribution ratio) toward an oxygenate. This is an essential condition for the development of a competitive extraction-based recovery process. Furthermore, such a solvent has to satisfy environmental, safety and health regulations, which are very strict if the oxygenate is used in the food or pharmaceutical industry (see Figure 1.4).

Although different polar solvents could be evaluated, in this approach water is selected as the most suitable option. Water is already present in generally any oxygenate production process, so its involvement would not cause contamination of the system. It is also preferable from environmental and also safety points of view. Furthermore, water, as a polar molecule, is practically immiscible with any apolar organic solvent.

Nevertheless, certain shortcomings also exist. Although a sufficient selectivity of water toward the oxygenates exists, its capacity for oxygenates is too low which would result in unacceptably high solvent-to-feed ratios, leading to economically unfeasible processes. As an illustration of the poor capacity of pure water toward oxygenates, Figure 1.1 shows the measured distribution ratio  $(K_D)_i$  of benzyl alcohol, benzaldehyde and benzoic acid between water and toluene, defined as the ratio of the oxygenate concentration in the aqueous phase ( $c_i^a$ ) to that in the organic phase ( $c_i^o$ ) at equilibrium:

$$(K_D)_i = \frac{c_i^a}{c_i^o} \quad (1-1)$$

The distribution of toluene itself is also included to give an insight in the selectivity toward oxygenates. The distribution ratio varies from 0.01 for the aldehyde to around 0.3 for the alcohol, whereas the selectivity (the ratio of distribution ratios of an oxygenate and toluene) goes from about 15 to about 500. Even the highest value of the distribution ratio, observed for the alcohol, will require a large number of equilibrium stages or/and a high solvent-to-feed ratio to achieve any reasonable recovery.

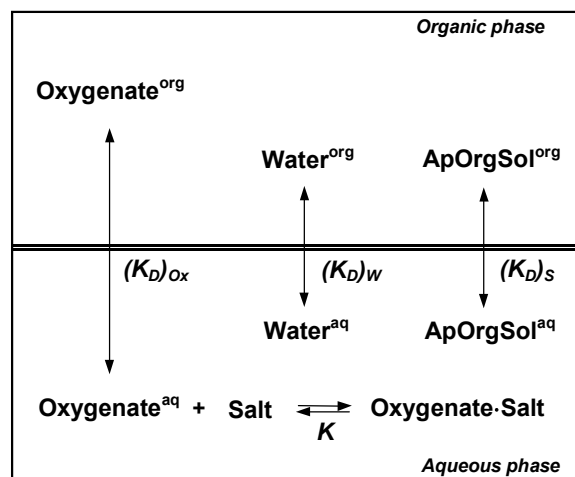


**Figure 1.1** Distribution ratio of oxygenates between pure water and toluene as a function of temperature: ●, benzoic acid; ▲, benzaldehyde; ▼, benzyl alcohol. The initial concentration of each oxygenate in the organic phase is 1.5 wt%. □ represents the distribution ratio of toluene.

To overcome this poor capacity of pure water, the introduction of environmentally and toxicologically benign salts in water, i.e., the use of aqueous salt solutions as extraction solvents, is considered. Salts, as charged compounds, are insoluble in apolar organic solvents, thus avoiding contamination of the organic phase.

It is known that salts have an effect on the concentration (activity) of organic solutes in water, referred to as salting-out or salting-in.<sup>1,2</sup> A salting-in effect toward oxygenates results in an increase of the distribution ratio. The selectivity can be improved not only by salting-in the oxygenate, but also by salting-out the apolar organic molecule. However, these effects typically are insufficient, causing, at best, a change in concentration of the organic solute in water of less than an order of magnitude.<sup>1</sup> Thus, such a change would not be sufficient for slightly water-soluble oxygenates to obtain high distribution ratios for an attractive extraction process having a reasonable number of stages with a reasonable solvent-to-feed ratio. For example, for the distribution ratio of benzaldehyde at least two, and preferably more, orders of magnitude are required (based on the values shown in Figure 1.1).

To intensify the role of the salt in enhancing the oxygenate solubility in water, besides physical, chemical interactions need to be exploited. The distribution of the oxygenate between the aqueous and apolar organic phase would significantly increase if the added salt selectively reacts with the oxygenate, modifying it into a charged compound (see Figure 1.2). Naturally, the interaction has to be reversible to be able to regenerate this chemically extracted oxygenate. In this way, aqueous salt solutions may be promising as reactive solvents.



**Figure 1.2** Scheme of reactive extraction of an oxygenate from the organic phase using an aqueous salt solution as the extraction solvent.

In Figure 1.2, the physical distribution of components between the aqueous salt solution and the organic phase is characterised by physical distribution ratios  $(K_D)_i$ . For the apolar organic solvent (ApOrgSol) it is very low, whereas for water it is very high. Partitioning of the salt and the extraction product (Oxygenate-Salt) between the two liquid phases may be neglected since they are, as charged compounds, completely insoluble in the organic phase. The reaction equilibrium constant  $K$  characterises the chemical equilibrium of the reversible reaction of the salt with an oxygenate. As this constant is higher, an overall distribution ratio of oxygenate  $D_{Ox}$  which is higher than its physical distribution ratio  $(K_D)_{Ox}$  will be achieved:

$$D_{Ox} \equiv \frac{c_{Ox}^a + c_{OxS}^a}{c_{Ox}^o} = (K_D)_{Ox} \cdot [1 + K \cdot c_{salt}^a] \quad (1-2)$$

Hence, a very efficient extraction solvent will be obtained if a salt which can react selectively with the oxygenate in a reaction with a high value of the equilibrium constant is applied. Nevertheless, an easy and complete regeneration of the chemically extracted product has also to be possible.

At the end, it should be emphasised that the use of salts as reactive extractants, but also the application of reactive extraction on the recovery of aldehydes, ketones and alcohols from an organic phase, is new compared to known examples of reactive extraction. In short, reactive extraction is applied to extract inorganic or organic acids, antibiotics and alcohols or inorganic ions from an aqueous solution into an organic solvent. Aliphatic amines or liquid ion exchangers like D2EHPA, different LIXes and TBP are used as reactive extractants.<sup>3-5</sup> Furthermore, acidic or basic organic components are extracted by dissociation extraction from an organic into an aqueous phase through the use of bases or acids dissolved in water.<sup>5,6</sup>

## 1.2 Potential field of application of the proposed extraction technique

Several important industrial processes in which a low- or a medium-water-soluble alcohol, aldehyde, ketone and/or carboxylic acid need to be recovered from an apolar (low-water soluble) organic solvent, in which they are present in a few-weight-percent concentrations, are shown below. They indicate the range of application of the proposed extraction technique.

### 1.2.1 Liquid-phase toluene oxidation

A typical industrial process is carried out in a bubbling column or in a stirred tank at temperatures between 120 and 180 °C and pressures between 2 and 9 bar.<sup>3-7</sup> The total residence time in the reactors mounted in series may vary from 2 to 30 hours.<sup>7</sup> The liquid stream withdrawn from the reactor contains unconverted toluene and, as many as 200 different products.<sup>8</sup> However, from the current market demand point of view, benzoic acid, benzaldehyde and benzyl alcohol can be considered as the most significant. Their uses, either as final products or as intermediates, are shown in Figure 1.3.

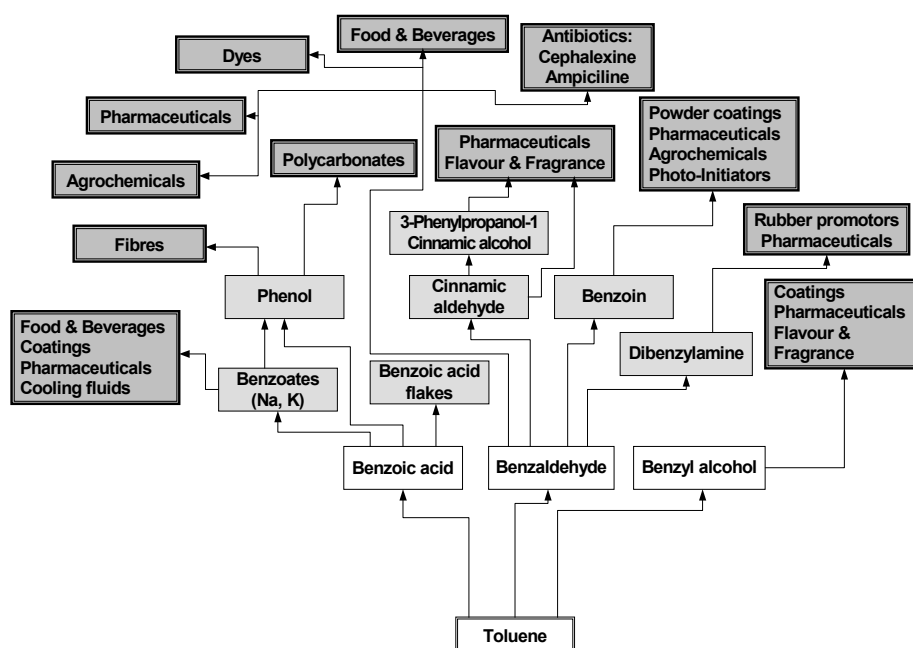
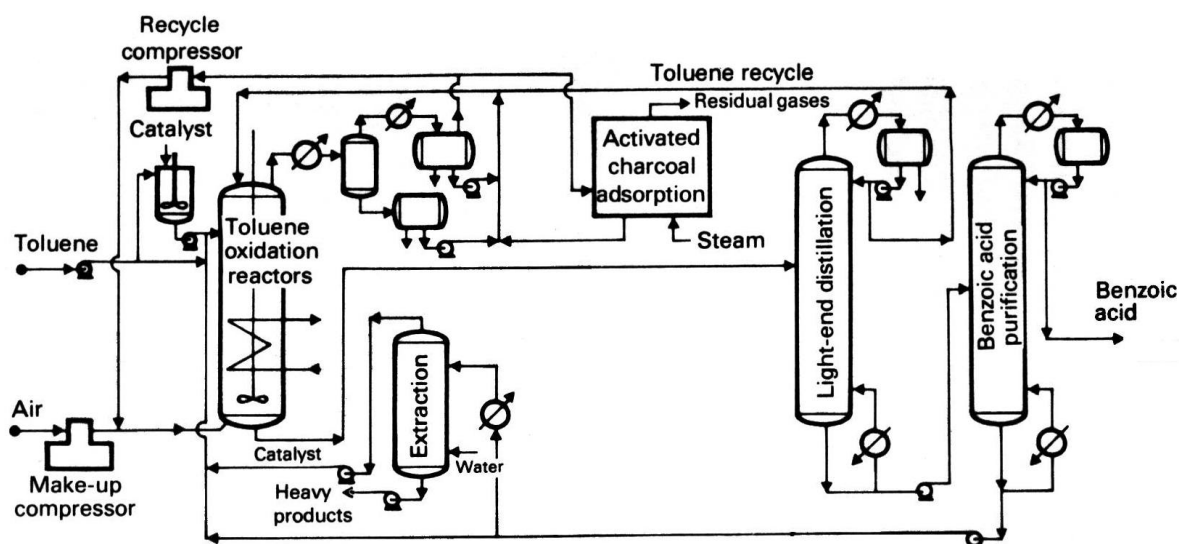


Figure 1.3 Applications of toluene oxidation products - benzyl alcohol, benzaldehyde and benzoic acid.<sup>9</sup>

The yield, i.e. the concentration of each valuable product in the reactor effluent, varies with the toluene conversion. For example, in case of a once-through conversion of toluene between 20 and 40 wt%, a high selectivity toward benzoic acid is achieved (91 to 93%).<sup>10</sup> Lower toluene conversions lead to a lower selectivity toward benzoic acid, but results in a concentration increase of benzaldehyde and benzyl alcohol. If the conversion of toluene is kept at 10%, then benzaldehyde is produced in the highest concentration which is 4 to 6 wt%.<sup>3,10,11</sup> And, if equal product quantities are required then the toluene conversion has to be reduced down to 5%. In that case, the concentration of each product in the reactor effluent is around 1.5%. Therefore, the oxygenate concentration in toluene may range from 1.5 wt% to 40 wt%.

Nowadays, the processes in which benzoic acid is the main product of interest and which ask for a high conversion of toluene are not attractive any more. Current market demand directs toward the production in which equal quantities of all three oxygenates are generated, i.e. toward a low toluene conversion and low product concentrations in the reactor effluent.

Two conventional toluene oxidation conventional processes, in which the oxygenate recovery is done by distillation, are presented in Figures 1.4 and 1.5. The former shows the first stage of the phenol production in which benzoic acid is the only product of interest, whereas in the latter more products are recovered.



**Figure 1.4** Flowsheet of the toluene oxidation process with distillative recovery of only benzoic acid (Dow/DSM process).<sup>10</sup>

### 1.2.2 Cyclohexane oxidation

The oxidation of cyclohexane is the first stage in the production of adipic acid and  $\epsilon$ -caprolactam. In both cases the products of interest are cyclohexanone and cyclohexanol. This oxidation is performed at a temperature of 130 to 180 °C and a pressure of less than 20 bar. The conversion of cyclohexane is kept around 5% to obtain a high selectivity toward cyclohexanol and cyclohexanone (a typical selectivity is 78%).<sup>12</sup> Therefore, those oxygenates appear in the reactor effluent in concentrations not exceeding 4 wt%.<sup>12-15</sup> To proceed to the second stage, they first must be recovered from the solution.

In a typical processes, the recovery and the separation of the products, is carried out by distillation (see Figure 1.6).<sup>12</sup>





oxidised in the liquid phase into cyclododecanol and cyclododecanone at 150-160 °C and atmospheric pressure. The conversion of cyclododecane is maintained at around 25% to obtain a selectivity toward the alcohol/ketone mixture of around 80%. At such conversion, the alcohol/ketone ratio is around 9 to 1, resulting in a ketone concentration of about 2%.<sup>15</sup>

### 1.2.4 Fischer-Tropsch process

Besides the above-mentioned oxidation processes, the Fischer-Tropsch process should also be highlighted as an important example in which oxygenates are separated from an apolar organic solvent. Linear aliphatic aldehydes and ketones, acids and alcohols containing up to 25 carbon atoms or under some process conditions even up to 40,<sup>16</sup> are produced.<sup>17,18</sup> They are present in the organic phase of the reaction condensate in concentrations not higher than a few percent.<sup>16,17,19,20</sup>

From that solution they are recovered by liquid-liquid extraction, in which solvent-to-feed ratios of up to 6:1 need to be applied to obtain the required recovery.<sup>18</sup> Besides that, due to limited immiscibility, it is necessary to separate significant amounts of the extraction solvent from the raffinate.

## 1.3 Scope and outline of this thesis

The objective of the research presented in this thesis is to explore the feasibility of using aqueous salt solutions as reactive extraction solvents for the recovery of the three classes of low- or medium-water-soluble oxygenates - carbonyl compounds, carboxylic acids and alcohols - from an apolar organic solvent in which they are present in a few-weight-percent concentrations. The potential feasibility will be evaluated by analysing whether suitable salts for each type of the considered oxygenates, which have a sufficiently high capacity toward the oxygenate, a high selectivity compared to the apolar organic solvent and which allow an efficient back-recovery of the extracted oxygenate, preferably applying a simple technique, exist.

In order to achieve that objective, distribution ratios of an oxygenate and a solvent in a two-phase-system at equilibrium for potentially suitable salt solutions will be measured. A similar approach will be used for the back-recovery, where simple tools for the regeneration of the chemically modified oxygenate, as a temperature or pH shift, will be tested under equilibrium conditions. Very roughly, an aqueous salt solution may be considered applicable if it provides an equilibrium distribution ratio for an oxygenate higher, and preferably much higher, than 1, has a selectivity toward the oxygenate at least the same as provided by pure water, and enables back-recovery by a temperature or pH shift.

As a reference case for the evaluation of the various salt solutions, either a solution of benzyl alcohol or benzaldehyde or benzoic acid in toluene is used. To explore the range of application, the most promising salt solutions found for those aromatic oxygenates are also evaluated for the extraction of a linear aliphatic and a cycloaliphatic oxygenate from an adequate solvent. In each case, the recovery from a single-solute solution is considered. Therefore, the thesis is organised in such a way that the recovery of each type of oxygenate is treated in a separate chapter. It should be emphasised that although the term back-recovery of extracted oxygenate is not explicitly mentioned in the titles of those chapters, both the forward-extraction and the back-recovery are analysed in each of them. The outline of each chapter is given below.

The necessity to characterise the extraction performance of many salt solutions created a need for a faster and more automated experimental procedure for gathering liquid-liquid

equilibrium data relative to the standard, manually operated jacketed-glass-cell-based-procedure. Therefore, an automated workstation for liquid-liquid equilibrium measurements has been developed. Its design and characteristics are presented in Chapter 2.

Chapter 3 covers the reactive extraction of aldehydes and ketones. Several salts, which are able to react reversibly with a carbonyl group, are considered for the recovery of different aldehydes and ketones from the corresponding apolar organic solvent. The influence of the type of salt and its structure on the extraction performance, as well as the differences in extraction performance of different carbonyl compounds are established. The back-extraction with a temperature shift is explored as the back-recovery option.

In Chapter 4 the extraction of carboxylic acids is explored. Since, the reactive extraction of acids, i.e. dissociation extraction, is a well-known technology, there is no need for establishing new extractants. However, an option for the extractive recovery of carboxylic acids which would not generate any new salts or involve consumption of strong mineral acids or bases as is the case in typical dissociation extraction processes, is proposed and investigated for various acids.

Chapter 5 deals with the reactive extraction of alcohols. The same approach as for aldehydes and ketones is applied and different compounds that could reversibly react with the hydroxyl group are explored as extractants. However, since doubts about the efficiency of such approach appeared in the case of alcohols (the possibility to reach high values of the distribution ratio in this way is questionable), another option is also considered. It involves the extraction of an alcohol modified into an easy-extractable form prior to the extraction. Hence, two options for the extraction of alcohols are evaluated.

Finally, based on the results presented in Chapters 3 to 5, potential conceptual process designs for the recovery of a mixture of oxygenates by reactive extraction with aqueous salt solutions are proposed in Chapter 6. This is done for the toluene oxidation process as a representative case in which three adequate oxygenates - benzyl alcohol, benzaldehyde and benzoic acid - need to be recovered from toluene. The optimal reactive extraction process is established and compared with the adequate distillation-based process to quantify the savings in the operational costs. Furthermore, in this chapter the experimental results of the extraction of an oxygenate in a pilot plant extraction setup are presented. These experiments are performed to evaluate if the proposed reactive extraction can be achieved in a typical extraction column.

Chapter 7 summarises the findings of this research and points out the issues that should be addressed in future work.

## Literature Cited

- (1) Long, F. A.; McDevit W.F. Activity Coefficients of Nonelectrolyte Solutes in Aqueous Salt Solutions. *Chem. Rev.* **1952**, *51*, 119-160.
- (2) Zemaitis, J. F. Jr. *Handbook of Aqueous Electrolyte Thermodynamics: Theory & Application*; American Institute of Chemical Engineers: New York, 1986; pp. 479-542.
- (3) Ullmann, F. *Ullmann's Encyclopedia of Industrial Chemistry. Oxidations*, 6th ed.; Wiley-Interscience: New York, 2001.
- (4) Bart, H. *Reactive Extraction*; Springer-Verlag: Berlin, 2001.
- (5) Pai, R. A.; Doherty, M. F.; Malone, M. F. Design of Reactive Extraction Systems for Bioproduct Recovery. *AIChE J.* **2002**, *48*, 514-526.
- (6) Perry, R. H.; Green, D. *Perry's Chemical Engineers' Handbook*; McGraw-Hill: Singapore, 1984.
- (7) Kirk, R. E.; Othmer, D. F. *Kirk-Othmer Encyclopedia of Chemical Technology*; Wiley-Interscience: New York, 2003.
- (8) Van Solingen, J. Analytical Chemistry Laboratory, DSM, Geleen, The Netherlands, personal communication, 2000.
- (9) DSM. Toluene Product and Application Tree. [http://www.dsm.nl/dfc/products/toluene/~en/toluene\\_tree.htm](http://www.dsm.nl/dfc/products/toluene/~en/toluene_tree.htm) (accessed July 2001).
- (10) Chauvel, A.; Lefebvre G. *Petrochemical processes 2 - Major oxygenated, Chlorinated and Nitrated Derivatives*; Gulf publishing company: London, 1989.
- (11) Stamicarbon B.V. Process for Treatment of Oxidation Products Formed by Oxidizing a Monoalkyl Benzene Compound or a Derivative Thereof. GB Patent 1,570,858, 1980.
- (12) Rehfinger, A.; Gann, M.; Markl, R.; Schmitt, R. Process for Preparing Oxidation Products from Cyclohexane in Counterflow. U.S. Patent 6,075,169, 2000.
- (13) Greene, M. I.; Summer, C.; Gartside, R. J. Cyclohexane Oxidation. U.S. Patent 6,008,415, 1999.
- (14) Pugi, K. Oxidation process. U.S. Patent 3,530,185, 1970.
- (15) Weissermel, K.; Arpe H. *Industrial Organic Chemistry*; VCH: New York, 1997.
- (16) Thomas, J. M.; Thomas, W. J. *Principle and Practice of Heterogeneous Catalysis*; VCH: New York, 1996; pp 525.
- (17) Dry, M. E. Fischer-Tropsch Reactions and the Environment. *App. Cat. A* **1999**, *189*, 185-190.
- (18) De Wet, J. P.; Scholtz, J. J. Separation of Oxygenates From a Hydrocarbon Stream. WO Patent 02/31085, 2002.
- (19) Di Sanzo, F. P.; Lane, J. L.; Bergquist, P. M.; Mooney, S. A.; Wu, B. G. Determination of Total Oxygenates in Fischer-Tropsch Liquid Products. *J. Chrom. A* **1983**, *281*, 101-108.
- (20) Maitlis, P. M.; Quyoum, R.; Long, H. C.; Turner, M. L. Towards a Chemical Understanding of the Fischer-Tropsch Reaction: Alkene Formation. *App. Cat A* **1999**, *186*, 363-374.



## Chapter 2

# Fully automated workstation for liquid-liquid equilibrium measurements

### 2.1 Introduction

The use of jacketed glass cells operated manually is the most commonly applied procedure for liquid-liquid equilibrium measurements. This approach is widely recognised as the standard procedure and the majority of equilibrium data are obtained in this way.<sup>1,2</sup> However, this procedure involves laborious work in preparation of solutions, introduction of chemicals in the cell, sampling, sample preparation for chemical analysis, cleaning, and so forth. As a consequence, the number of experiments that can be performed per day is limited by the amount of work that can be performed by the experimenter. Furthermore, each of the steps done manually is subject to a potential experimenter's error that may reduce the accuracy of the results. Therefore, partial or, even better, full automation of the liquid-liquid equilibrium determination procedure would open the possibility for more measurements to be done per day, with a human- and time-independent accuracy. As a result, a more detailed and more accurate experimental characterisation of two-phase systems as well as a more rapid screening of extraction solvents would be possible.

A short literature overview of the equipment used for this purpose, going from partial toward complete automation and from automation of the extraction procedure in general toward specific automation of liquid-liquid equilibrium measurements, is given below.

Automated liquid handling systems are the most simple and common cases of automation. These systems are used by many laboratories dealing with small-scale batch liquid-liquid extraction in order to speed up the procedure. As examples, the programmable liquid handling workstations Quadra (Tomtec, USA)<sup>3</sup> and MicroLab AT Plus 2 (Hamilton, USA),<sup>4</sup> are mentioned. They are used for the rapid screening of extraction solvents needed for purification of combinatorial chemistry samples during drug development,<sup>5</sup> in quantification of drugs in biological fluids based on liquid-liquid extraction,<sup>6</sup> or for determination of components in human plasma, again based on liquid-liquid extraction.<sup>7</sup> Although such instruments significantly decrease a part of the manual handling by performing all liquid transfers, still, other operations involved in liquid-liquid extraction, like agitation, transfer of vessels or sample analysis, have to be done either manually<sup>6</sup> or in other automated setups.

Mettler Toledo's automated liquid-liquid extraction unit Alex (Mettler Toledo Bohdan, USA) is an example of an instrument that could provide a higher level of automation. It can bring two liquids in contact, mix them, automatically determine the phase boundary after settling and perform an efficient phase separation.<sup>8,9,10</sup> Nevertheless, the preparation of liquid solutions, the workup of samples for analysis and the analysis itself still ask for manual work.

Full automation of liquid-liquid equilibrium measurements may be possible by using a system such as Zymate (Zymark, USA). Zymate is an advanced robotic system that consists of a centrally positioned robot arm and of modules located around it.<sup>11</sup> The arm moves vials from one module to another where operations, such as liquid transfer, dilution, mixing, centrifugation, or analysis, are performed. Each module is a separate automated workstation and as such is locked into a position on a circular holder. All modules and the robot arm are controlled from the central system controller. Modules are chosen depending on the operations that need to be performed. Although such a robotic system would be able to handle all operations of a liquid-liquid equilibrium experiment, to our knowledge it is still not used for this purpose. The probable reasons are its rather high complexity, laboratory space requirements and above all its high price that is at least 10 to 15 times higher than the price of a typical gas chromatograph unit.

In contrast to the instruments mentioned up till now, which are aimed as wide application range systems, Meab's Akufve (Meab, Sweden) is a setup developed specifically for measurement of the partitioning coefficients in liquid-liquid systems.<sup>12</sup> Akufve has not a robot arm for liquid transfer but a system of tubes and valves. Liquids introduced in this system are vigorously mixed and then drained through a valve-tube system into a continuous flow centrifuge for phase separation. Each of the phases is pumped back into the mixer and on its way can be sampled or connected to an on-line analysis unit. Although this unit provides a powerful tool for liquid-liquid equilibrium measurements with a significant level of automation, still, the sampling and preparation of samples in case when no on-line analysis unit exists, as well as the preparation of solutions and their introduction in the system, have to be done manually.

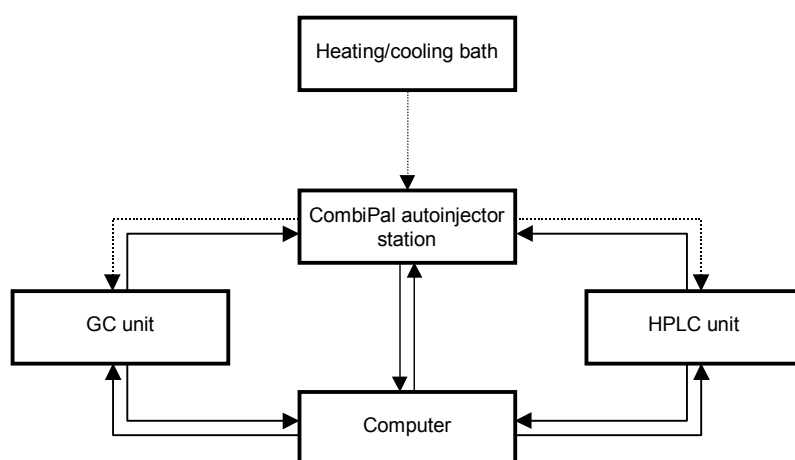
A liquid-liquid flow extraction procedure, like the one applied to the determination of equilibrium partition coefficients of different compounds in the octanol-water system,<sup>13</sup> gives another possibility for automation of the liquid-liquid equilibrium measurements. The aqueous and organic phases are alternatively pumped into a capillary tube directly from the storage vials. Once in the capillary, the two-phase plug, led and followed by an air bubble, is pumped back and forward through the tube until equilibrium is reached. The composition of both phases is analysed by an analytical method that does not require sampling, like UV-vis spectrophotometry, when the plug passes through a detector. After data are acquired, the liquids are pumped out of the capillary and the next measurement can be done. This procedure provides a very high degree of automation using extremely low volumes of chemicals per experiment (in nanoliters). However, its limitation to non-sampling analytical methods only may be a significant disadvantage. If such a method is not applicable, as is often the case (especially for multicomponent systems), manual sampling of phases and sample preparation would have to be done and that could be very demanding.

In this work, a setup for liquid-liquid equilibrium measurements that is fully automated, requires rather low equipment investments (comparable to the price of a typical gas chromatograph) and is very space efficient, is presented. All operations, from preparation of aqueous and organic solutions, liquid transfer into a vial, agitation, phase sampling, sample preparation for analysis and chemical analysis itself are done automatically. To show its

applicability and explore the accuracy and repeatability of the procedure, the distribution ratio of acetone between toluene and water, and the distribution ratio of caprolactam between an organic phase (toluene or benzene) and water have been measured. The results are compared with those reported in the literature and those obtained using a jacketed glass cell operated manually.

## 2.2 Workstation for automated measurements

The workstation is built from commercially available modules, which were only slightly adjusted in order to be used for the purpose of liquid-liquid equilibrium measurements. It includes a CombiPal advanced autoinjector station (CTC Analytics, Switzerland),<sup>14</sup> a gas chromatograph (GC) CP-3800 (Varian, USA), a high-pressure liquid chromatograph (HPLC) ProStar (Varian), a heating/cooling bath with external temperature control (Julabo Labortechnik, Germany), and a personal computer (see Figure 2.1).

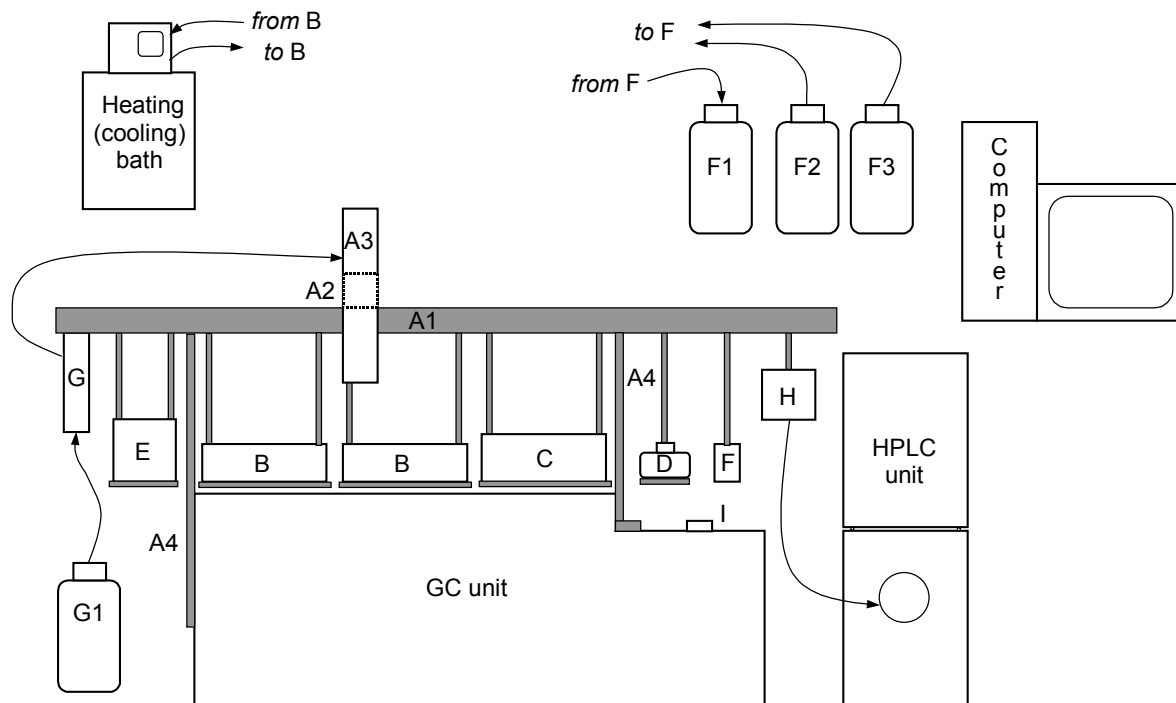


**Figure 2.1** Sections of the workstation (dashed lines denote fluid flow, while full lines denote electrical signal flows).

The heart of the system is the CombiPal autoinjector station. It has three crossrails,  $x$ ,  $y$  and  $z$  (A1, A2, and A3 in Figures 2.2 and 2.3) which allow a robot arm movement in all three dimensions. Besides allowing movement of the robot arm in the  $x$ -direction, the  $x$ -crossrail (A1) also serves as the carrier on which different modules are mounted. Modules present in the configuration described in this work and shown in Figures 2.2 and 2.4 are two 2 ml vial tray holders with trays (B), a 20 ml vial tray holder with tray (C), a 100 ml vial holder (D), an orbital shaker (E), a washing station (F), a dilutor syringe (G), and a remote HPLC injector (H). Furthermore, on the  $x$ -crossrail two vertical holders (A4) are present, with the help of which the CombiPal is attached on the gas chromatograph. The  $z$ -crossrail (A3) is the host for a syringe holder and the vial lifter. In this way, the syringe and vials can reach any coordinate within the range of the crossrails, that is, all modules on the crossrail as well as the GC injector (I). In the configuration discussed in this work, an 80  $\mu\text{l}$  syringe is mounted on the syringe holder.

The syringe's plunger can be moved in the  $z$ -direction independently on the movement of the syringe, allowing injection or ejection of the liquid. Very accurate control of the plunger's position in combination with calibration of its initial position before any injection allows very reproducible liquid transfers. The repeatability, characterised by the relative standard deviation of a 10 times repeated transfer of 20  $\mu\text{l}$  of water by this syringe, that is, at 25% of its full capacity, is measured to be 0.5%. It should be emphasised that the plunger

can be moved only in increments of 0.1 mm. This means that the transferred amount would differ from the required amount by not more than 0.1% if quantities in the full range of the syringe are transferred (full scale has a length of 48.0 mm). However, the error increases up to 1% when only 10% of its capacity is used. Therefore, transferring quantities in the lower part of the syringe's capacity range should be avoided.



**Figure 2.2** Scheme of the automated workstation: A1, x-crossrail; A2, y-crossrail (can be seen in Figure 2.3); A3, z-crossrail; A4, vertical holders; B, 2 ml vial tray holder with tray; C, 20 ml vial tray holder with tray; D, 100 ml vial holder with three vials; E, orbital shaker; F, washing station; F1, waste disposal tank; F2 and F3, washing solvent storage tank; G, dilutor syringe; G1, diluting fluid storage bottle; H, remote HPLC injector; I, GC injector.

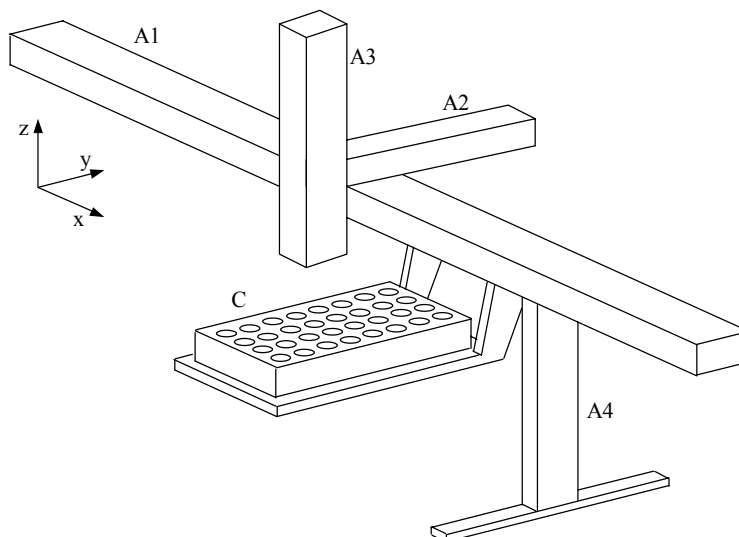
By use of this automated workstation, the liquid-liquid equilibrium is established in 2 ml glass vials closed by a metal crimp seal with a septum. Seals made of metal enable picking-up and moving of a vial by the magnetised end of the vial lifter. The septum has a teflon/silicone/teflon layer structure providing satisfying chemical stability toward many solvents.

Before the automated procedure can be initiated, certain preparative activities have to be done by the experimenter. The CombiPal operation sequence has to be defined (it needs to be defined only once and can be reused as many times as required), the storage tanks have to be filled with the chemicals required for the experiments, the empty sealed vials, in which equilibrium will be established, have to be placed in their positions and finally, the sample sequence list for gas and/or liquid chromatography has to be defined.

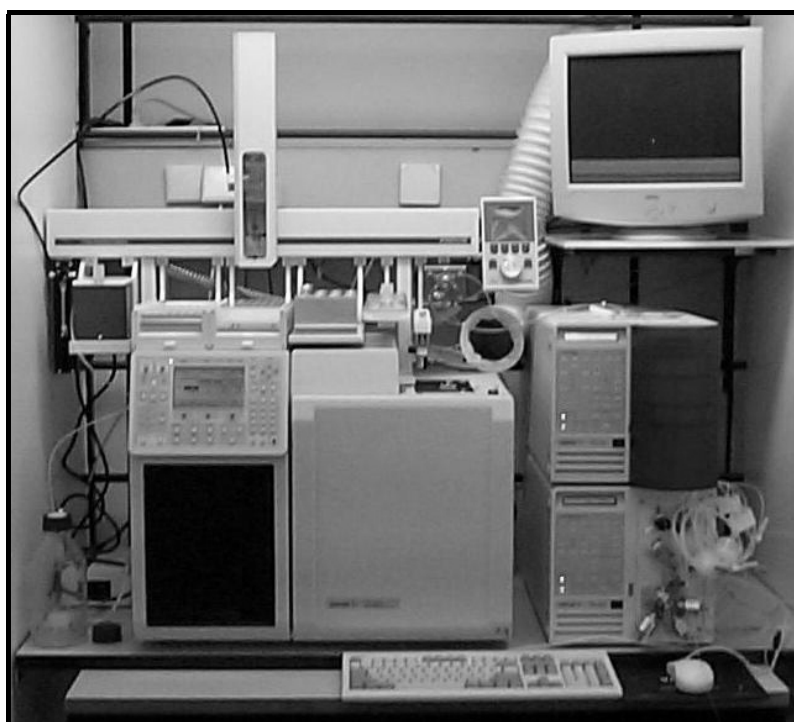
The first step of the automated procedure is the transfer of liquids by syringe from the storage vials into the empty, sealed equilibrium vials that are placed in trays (Figure 2.2, B). The 20 ml vials (in tray C), 100 ml vials (D), and 1 l bottle (G1) are used for storage of chemicals required for the experiments. It should be emphasised that since this system is able to handle liquids only, solid chemicals have to be provided in solution. Up to thirty-two 20 ml and three 100 ml vials and one 1 l bottle can be used in the configuration described in this work. Chemicals from the 20 and 100 ml vials are transferred directly by the 80  $\mu$ l syringe, while for distribution of liquid from the 1 l vessel the 2.5 ml dilutor syringe (G) connected



by plastic tubes to the 80  $\mu\text{l}$  syringe is used. The tube originates in the bottle, goes via the dilutor syringe, and ends in the sideport of the 80  $\mu\text{l}$  syringe. The dilutor syringe sucks the required quantity of the liquid from the bottle and moves it through the sideport of the 80  $\mu\text{l}$  syringe into a vial on the tray (B). For this purpose, the plunger of the 80  $\mu\text{l}$  syringe is positioned above the sideport opening so that the liquid can pass through this syringe into a vial.



**Figure 2.3** 3D scheme of the workstation's crossrails A1, A2 and A3 (one of the fixation holders A4 and the vial tray holder with tray C are included).



**Figure 2.4** Photo of the workstation (the heating/cooling bath and computer are not shown).

Once this is done, the vials are lifted and moved by the robot arm into the orbital shaker (E) for agitation. Since the shaker can accommodate not more than six vials per run, the agitation has to be done in groups of six, if only one shaker is installed like in our configuration. The direction of the shaker's orbital movement is alternated, with a pause

between changes, where the rotation intervals and the duration of the break can be specified. Electrical heaters in the shaker allow a regulation of the temperature during agitation in the range from room temperature up to  $300 \pm 0.5$  °C.

After agitation (the duration required for agitation has to be determined in advance), the vials are picked up and moved back into their original positions in a tray, where phase settling occurs. The heating/cooling fluid flows through the inner space of this tray and maintains the desired temperature during settling. Each 2 ml tray is made from metal and has two openings at the backside for connection of the tubes coming from the heating/cooling bath. In the current configuration, both trays are connected to the same bath. For the purpose of temperature regulation, a small PT-100 probe (uncertainty of 0.01 °C at 25 °C), connected to the heating/cooling bath, is submerged in a 2 ml vial filled with water and this vial is placed in one of the trays. Thereby, the temperature of the circulating fluid can be adjusted to maintain the required temperature of the liquid in the vials. In this way, the temperature of the liquid in one single position in one of the trays represents the temperature for all positions and both trays. Knowing that the maximum temperature difference between any two different positions in a tray is measured to be not more than 0.1 °C, this approach is justified.

After the settling is completed (the duration required for settling has to be determined in advance), samples of both phases are taken. This is done by the syringe from the top of the vials, first a sample of the upper phase and then a sample of the lower phase. For this operation, a low needle penetration and retraction speed (800  $\mu\text{m/s}$ ) and liquid suction rate (1.5  $\mu\text{l/s}$ ) are applied to maintain the system as undisturbed as possible. The penetration (retraction) speed can be chosen in the range of 1  $\mu\text{m/s}$  up to 10 mm/s, while the suction rate ranges from 1.0  $\mu\text{l/s}$  up to 0.5 ml/s. To minimise contamination of the lower phase sample due to the needle travelling through the upper phase, a defined amount of the withdrawn sample was first ejected into the waste (to wash the needle with the sample) before the sample was disposed into a vial. The same is done with the last portion present in the syringe. Additionally, the sample of the lower phase was taken close to the bottom of the vial allowing needle wetting by the lower liquid before suction is commenced. Each sample is transferred into an empty, sealed 2 ml vial and is diluted in an adequate solvent. The dilution is done to enable sample analysis, but also to prevent potential second phase formation due to a possible temperature change. The dilution solvent is stored in the 1 l bottle (Figure 2.2, G1), and is therefore dispensed in the sample vial using the dilutor syringe (G). Finally, if required for quantitative analysis, an internal standard can also be introduced, either from a separate storage vial or together with the dilution solvent. After this is done, the sample vials are transferred into the orbital shaker and agitated for several minutes to homogenise the solution. Finally, these prepared samples are injected either into the gas chromatograph injector (I) or into the external injection valve of the high-pressure liquid chromatograph (H) for quantitative analysis. With calibration curves determined and implemented in the analysis software, the component concentrations in both phases will be directly obtained.

It should be emphasised that before any liquid transfer, the syringe and its needle are washed in the washing station (F). The station has two ports for washing and one for waste disposal. Washing ports are connected to the washing solvent 1 l storage tanks (F2, F3), and waste disposal to a waste tank (F1). Any liquid waste generated during the experiment is disposed in this port.

The system is operated from the personal computer connected to the CombiPal, gas chromatograph, and high-pressure liquid chromatograph as shown in Figure 2.1. Windows-based custom-made software Cycle Composer (CTC Analytics) is used to operate the

CombiPal autoinjector. For the operation of the chromatographs and chromatogram analysis, Star software (Varian) is used.

## 2.3 Liquid-liquid equilibrium measurements

By use of the automated workstation, liquid-liquid equilibria were measured for three two-phase systems often found in the literature: toluene + water + acetone, toluene + water + caprolactam, and benzene + water + caprolactam. The reason for choosing the toluene-water-acetone system is that it has been declared as one of the standard test systems for liquid-liquid extraction by the Society for Chemical Engineering and Biotechnology (DECHEMA)<sup>15</sup> and is therefore very well characterised in the literature. The other two systems, although not recognised as standard test systems, are selected because their characterisation is part of our wider research activities and they also represent cases with significantly different physical properties (interfacial tension, viscosity, etc.) from the acetone system. The equilibrium is measured in the first case at 20 °C and for the last two systems at 40 °C (toluene) and at 20 °C (benzene). The equilibrium data determined for the acetone system are compared with the values reported in the literature that are recognised as the reference for this system.<sup>16</sup> On the other hand, since no recognised reference exists for the caprolactam systems, the equilibrium composition for these cases is measured in a jacketed glass cell operated manually and those results, together with the values found in the literature,<sup>17-20</sup> were used for comparison.

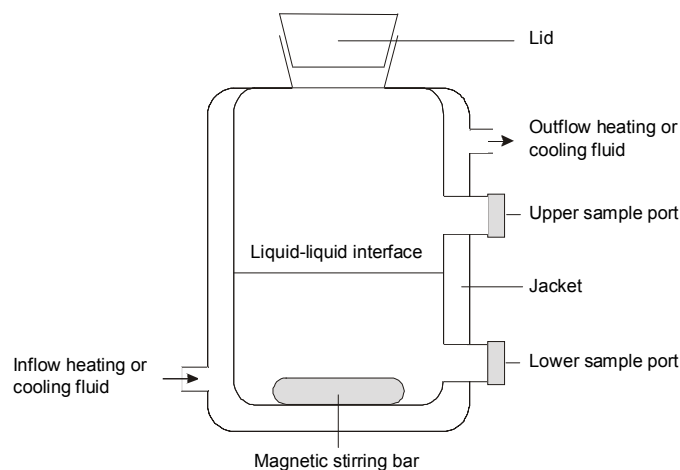
### 2.3.1 Chemicals

Toluene (purity 99%) was supplied by Fluka (USA), benzene (purity >99.5%) by Riedel de Haën (USA),  $\epsilon$ -caprolactam (purity 99%) by Sigma-Aldrich (USA), ethanol (purity 99.8%), acetone and methanol (purity >99.8%) by Merck (Germany) and 1-methyl-2-pyrrolidone (purity 99%) by Acros (Belgium). All chemicals were used as received. MilliQ water was used in all experiments.

### 2.3.2 Equilibrium measurements in the jacketed glass cell operated manually

A scheme of the jacketed glass cell is shown in Figure 2.5. The cell has an inner chamber of about 55 ml that is surrounded by a jacket for temperature control. The jacket is connected to a Julabo F12 heating/cooling bath (Julabo Labortechnik), where water was used as the heating/cooling fluid. The inner chamber has two sampling ports, one in the upper half and the other in the lower half of the cell, allowing sampling of both phases. The cell stands on the plate of a multiple point magnetic stirrer (Variomag). A magnetic bar (30 mm length) is used for agitation.

Equilibrium measurements were performed as follows. Twenty milliliters of the organic solvent (toluene or benzene) and 20 ml of an aqueous caprolactam solution were introduced in the vessel by a pipet. The caprolactam mass fraction in the initial aqueous solution was in the range from 0 up to 60 wt%. After introduction of the solutions, the mixture was stirred at 450 rpm at a regime of 90 s stirring and 20 s pause. After equilibrium was reached (the time of agitation required to reach equilibrium was determined prior to equilibrium experiments) the mixture was left to settle for 1 h. During the agitation and settling, the temperature of the fluid in the vessels was kept constant at the required value with an uncertainty of 0.1 °C. After the phases settled, samples from both the organic (100  $\mu$ l) and the aqueous layer (20  $\mu$ l) were taken with a syringe.



**Figure 2.5** Manually operated glass cell used for the determination of liquid-liquid equilibria.

### 2.3.3 Equilibrium experiments on the automated workstation

On the automated workstation, the equilibrium was established in 2 ml glass vials in which acetone or 60 wt% aqueous caprolactam solution, pure water, and organic solvent (toluene or benzene) were introduced. In case of caprolactam as the solute, the volume of organic solvent was 900  $\mu\text{l}$ , the volume of caprolactam solution was in the range of 54  $\mu\text{l}$  to 900  $\mu\text{l}$ , and the volume of pure water depended on the amount of caprolactam solution which was added in such quantities that the sum of the volumes of the caprolactam solution and pure water is 900  $\mu\text{l}$ . In this way, the initial organic to aqueous phase volume ratio was equal to 1, while the mass fraction of caprolactam in the aqueous phase was varied. In case of acetone, equal volumes of toluene and pure water were introduced, in such way that the total liquid volume was 1800  $\mu\text{l}$ . The organic solvent and pure water were stored in 100 ml vials, while a 20 ml vial was used for acetone or the 60 wt% caprolactam solution.

It should be emphasised that before any liquid transfer, the syringe was first washed in ethanol and then in toluene/benzene, water, or acetone. The washing station and a 20 ml vial filled with toluene or benzene, a 20 ml vial filled with water, and one filled with acetone were used for this purpose.

After the filling, the vials were transferred into the orbital shaker and agitated. The shaking was done by applying 750 rpm, with 30 s of rotation in one direction, a 5 s pause and 30 s of rotation in the opposite direction. The time of shaking required to reach equilibrium was determined on the same automated workstation prior to equilibrium experiments (see Section 2.4.1). The temperature inside the shaker was kept either at 20  $^{\circ}\text{C}$  or at 40  $^{\circ}\text{C}$ . Here, it has to be emphasised that the shaker is capable of heating only (no cooling is currently available). Therefore, the setup is limited to experiments at temperatures higher than room temperature. At the period these experiments were done, the room temperature was below 20  $^{\circ}\text{C}$ . After shaking, the vials were returned to the trays for settling. The temperature in the 2 ml trays was also maintained at 20  $^{\circ}\text{C}$  or at 40  $^{\circ}\text{C}$ , depending on the experiment. Water was used as the heating/cooling fluid. The settling was done for at least 1 h.

After settling, 100  $\mu\text{l}$  of the organic phase and 25  $\mu\text{l}$  of the aqueous phase were sampled for the caprolactam system, while 180  $\mu\text{l}$  of each phase was taken in the acetone case. Each sample was transferred into an empty 2 ml vial. Caprolactam samples were diluted with 1000  $\mu\text{l}$  of ethanol and after that 50  $\mu\text{l}$  of the internal standard was added. Acetone samples were diluted with 400  $\mu\text{l}$  of methanol whereinto 65  $\mu\text{l}$  of internal standard was introduced.

The vials were transferred into the shaker, agitated for 3 min and returned back into the 2 ml trays to settle for at least 10 min to achieve a homogeneous solution. After that, a sample was injected into the gas chromatograph for quantitative analysis.

### 2.3.4 Chemical analysis

The mass fraction of caprolactam in both the organic and the aqueous phase, was determined in a gas chromatograph, CP-3800 (Varian), equipped with a EC-WAX column (30 m, 0.32 mm; 0.25  $\mu\text{m}$  film thickness) and a FID detector. During the analysis, the column temperature was raised from 60  $^{\circ}\text{C}$  to 70  $^{\circ}\text{C}$  with an increment of 10  $^{\circ}\text{C}/\text{min}$  and then from 70  $^{\circ}\text{C}$  to 250  $^{\circ}\text{C}$  with an increment of 50  $^{\circ}\text{C}/\text{min}$ . The temperatures of the injector and detector were kept constant at 225  $^{\circ}\text{C}$  and 250  $^{\circ}\text{C}$ , respectively, with a pressure in the injector of 275 kPa (analysis of samples from jacketed glass vessel) or of 138 kPa for analysis of samples from the automated workstation. A split ratio of 10 was used in both cases. For the analysis performed at the automated workstation, hydrogen was used as the carrier gas with an initial flow of 1.5 ml/min, while a sample of 1.5  $\mu\text{l}$  was injected into the column. In the case of glass cell experiments, helium was used as the carrier gas with an initial flow of 14.2 ml/min and a sample of 0.3  $\mu\text{l}$  was injected into the column. Quantification of caprolactam in the sample was done by using an internal standard method where 1-methyl-2-pyrrolidine was used as the internal standard.

A 10 wt% aqueous caprolactam solution was prepared and analysed four times to test the repeatability and the accuracy of the GC analysis. A mean value of 9.79 wt% is found with an uncertainty of 0.26 wt% (determined as standard deviation).

The mass fraction of acetone in both the organic and the aqueous phase was determined by the same gas chromatograph, but equipped with a CP-SIL 5CB column (25 m, 0.15 mm; 1.2  $\mu\text{m}$  film thickness). In this case the column temperature was raised from 60  $^{\circ}\text{C}$  to 100  $^{\circ}\text{C}$  with an increment of 10  $^{\circ}\text{C}/\text{min}$  and then from 100  $^{\circ}\text{C}$  to 270  $^{\circ}\text{C}$  with an increment of 60  $^{\circ}\text{C}/\text{min}$ . The temperatures of the injector and detector were kept constant at 270  $^{\circ}\text{C}$  and 300  $^{\circ}\text{C}$ , respectively, with a pressure in the injector of 173 kPa and a split ratio of 40. Hydrogen was used as the carrier gas with an initial flow of 0.9 ml/min. Quantification of acetone in the sample was also done by using 1-methyl-2-pyrrolidone as the internal standard.

### 2.3.5 Data analysis

The distribution ratio of a solute  $i$  ( $K_D$ ) <sub>$i$</sub>  is defined as the ratio of the determined solute mass fraction in the organic phase ( $w_i^o$ ) to the one in the aqueous phase ( $w_i^a$ ) at equilibrium:

$$(K_D)_i = \frac{w_i^o}{w_i^a} \quad (2-1)$$

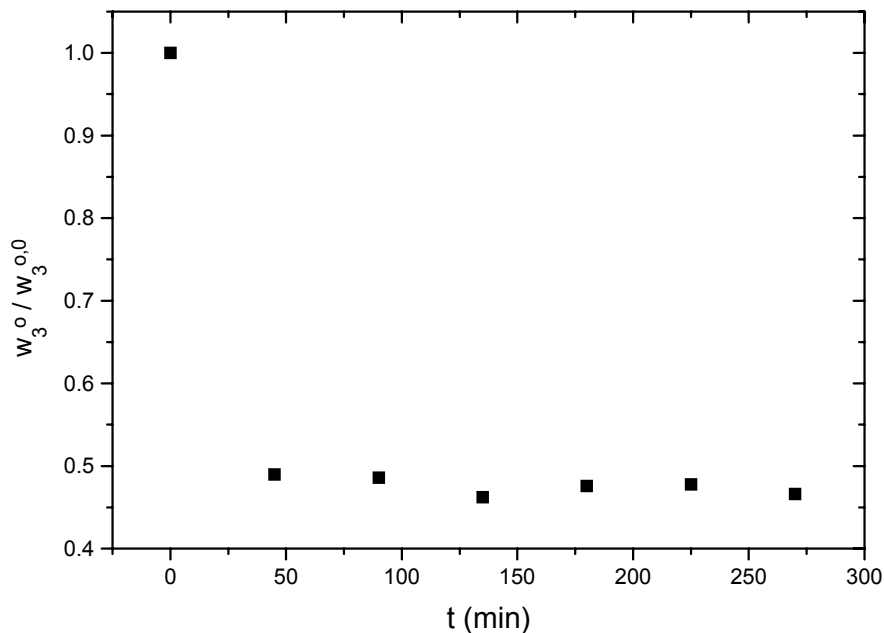
This distribution ratio was used for presentation of the experimental results and their comparison with the literature values.

## 2.4 Results and discussion

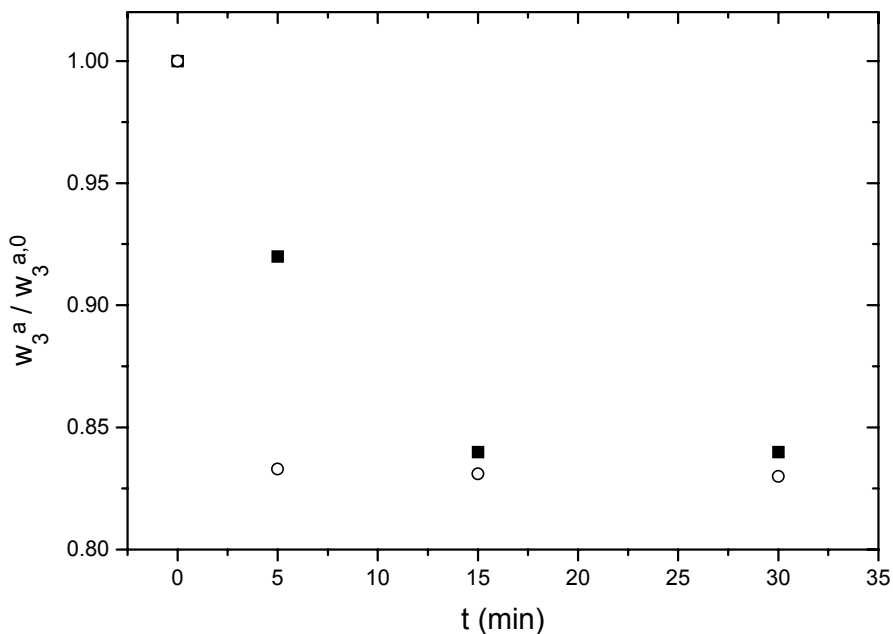
### 2.4.1 Equilibration time

Prior to equilibrium measurements, the time of agitation required to reach equilibrium for specific experimental conditions (experimental setup, components, temperature) was determined. Although the time to reach equilibrium may somewhat differ for different initial mass fractions of the solute due to a change of physical properties of the system (like

viscosity, interfacial tension, and density), this difference was not considered significant. Therefore, the mass fraction change of acetone or caprolactam in the organic or aqueous phase, was monitored as a function of time of agitation for one initial solute mass fraction. For the acetone system, the results obtained on the automated workstation are given in Figure 2.6, while for caprolactam those obtained in the jacketed glass cell are given in Figure 2.7 and those on the automated workstation in Figure 2.8.

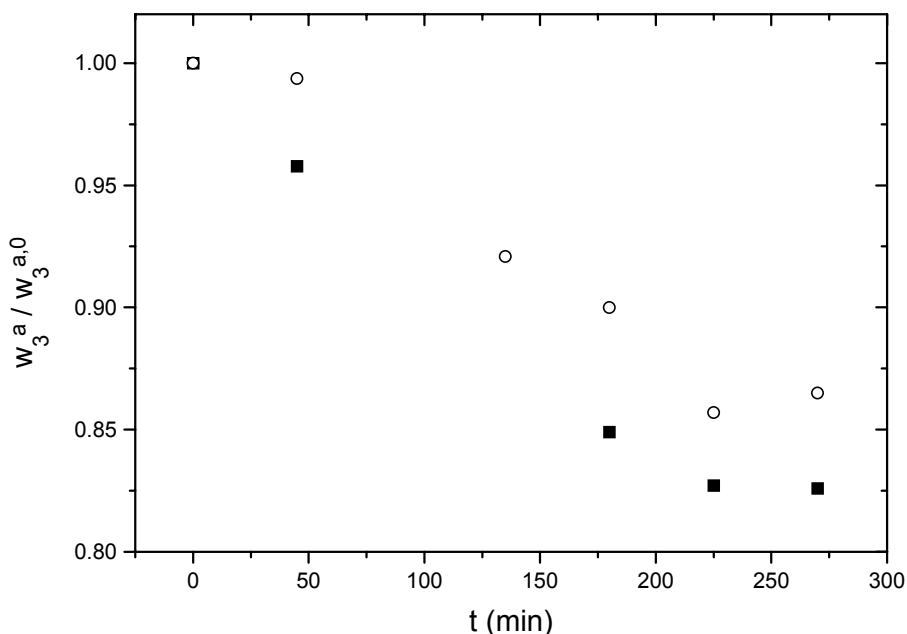


**Figure 2.6** Profile of the normalised mass fraction of acetone in the organic phase as a function of time of agitation obtained at the automated workstation in the system toluene (1) + water (2) + acetone (3) at 20 °C. Introduced quantities: 900  $\mu$ l of toluene, 225  $\mu$ l of acetone and 675  $\mu$ l of water.



**Figure 2.7** Profile of the normalised mass fraction of caprolactam in the aqueous phase as a function of time of agitation obtained in the jacketed glass cell: ■, benzene (1) + water (2) + caprolactam (3) at 20 °C; ○, toluene (1) + water (2) + caprolactam (3) at 40 °C. Introduced quantities: 20 ml of toluene or benzene and 20 ml of 10 wt% aqueous caprolactam solution.

In the jacketed glass cell, it seems that after 25 min of agitation the equilibrium for the caprolactam extraction was reached. On the automated workstation, a significantly longer time was required for both the caprolactam and the acetone system. In the first system, it was in the range of 250 min for both solvents, whereas around 130 min was enough for acetone extraction. Obviously, the agitation of liquids in the 2 ml round vials by the orbital shaker is far less efficient than agitation in the large jacketed glass cell by a magnetic stirrer. Furthermore, it is clear that physical properties of the system also influence equilibration time. With the same energy input, the more viscous caprolactam solution needs twice the time to reach equilibrium than is the case for the acetone system.



**Figure 2.8** Profile of the normalised mass fraction of caprolactam in the aqueous phase as a function of time of agitation obtained at the automated workstation: ■, benzene (1) + water (2) + caprolactam (3) at 20 °C; ○, toluene (1) + water (2) + caprolactam (3) at 40 °C. Introduced quantities: 900 µl of benzene or toluene, 225 µl of 60 wt% aqueous caprolactam solution, and 675 µl of water.

## 2.4.2 Equilibrium results

The distribution ratios of acetone and caprolactam have been measured as a function of the solute equilibrium mass fraction in the aqueous phase. The results are shown in Figures 2.9 - 2.11 (for the values see Tables 2.1 and 2.2). The accuracy of the measurements performed on the automated workstation has been characterised by the deviation of measured results from the values measured in the jacketed glass cell, but also from those found in the literature.

The measured values of the distribution ratio of acetone are all exactly within the cloud of the literature data, with the exception of the point at 25 wt% acetone in the aqueous phase, which is at its border. Similar results are obtained for the systems toluene-water-caprolactam and benzene-water-caprolactam, where the values measured on the automated workstation generally lay in the cloud of data acquired in the jacketed glass cell. Furthermore, the literature values for the last two systems also agree with the findings presented in this work, with the exception of the data reported by Morachevskii et al.<sup>18</sup> for the benzene-water-caprolactam system, in the lower mass fraction range of caprolactam. From the obtained results for all three systems, it may be concluded that a very good accuracy of the automated workstation exists.

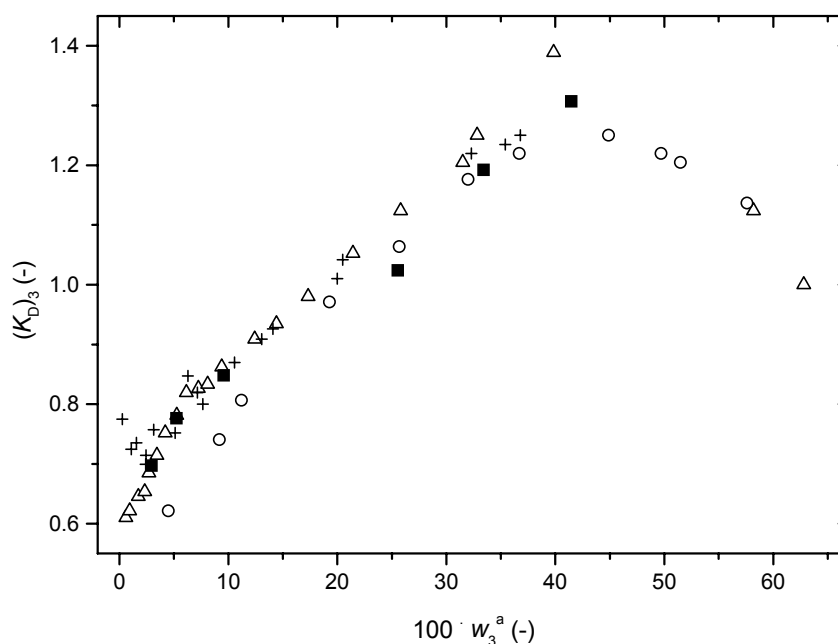
**Table 2.1** Distribution ratios determined at the automated workstation.

| $100w_3^a$ (-)                          | $(K_D)_3$ (-) | $100w_3^a$ (-) | $(K_D)_3$ (-) | $100w_3^a$ (-) | $(K_D)_3$ (-) |
|---|---------------|----------------|---------------|----------------|---------------|
| Acetone system <sup>a</sup>             |               |                |               |                |               |
| 2.94                                    | 0.697         | 9.58           | 0.848         | 33.4           | 1.19          |
| 5.23                                    | 0.777         | 25.6           | 1.02          | 41.5           | 1.31          |
| Caprolactam-toluene system <sup>b</sup> |               |                |               |                |               |
| 3.69                                    | 0.100         | 14.6           | 0.130         | 39.4           | 0.187         |
| 6.97                                    | 0.117         | 27.9           | 0.150         | 54.1           | 0.286         |
| Caprolactam-benzene system <sup>c</sup> |               |                |               |                |               |
| 3.63                                    | 0.104         | 13.8           | 0.164         | 36.4           | 0.306         |
| 7.37                                    | 0.127         | 24.2           | 0.226         | 51.7           | 0.364         |

<sup>a</sup> Toluene (1) + water (2) + acetone (3) at 20 °C

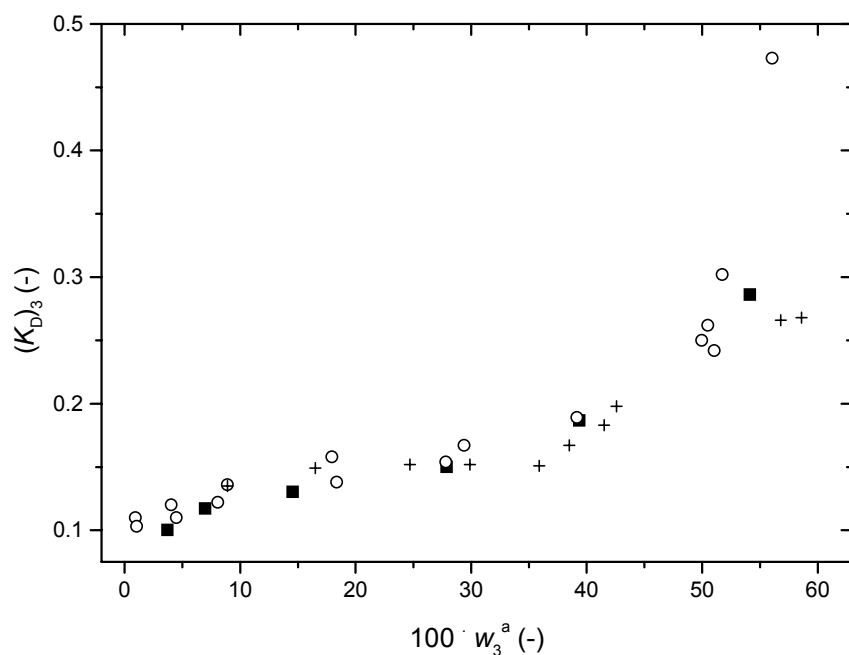
<sup>b</sup> Toluene (1) + water (2) + caprolactam (3) at 40 °C

<sup>c</sup> Benzene (1) + water (2) + caprolactam (3) at 20 °C



**Figure 2.9** Distribution ratio of acetone in the system toluene (1) + water (2) + acetone (3) at 20 °C as a function of the mass fraction of acetone in the aqueous phase at equilibrium: ■, automated workstation, this work; Δ, Hackl *et al*, 1975;<sup>16</sup> ○, Pavasovic, 1975;<sup>16</sup> +, Brandt *et al*, 1975.<sup>16</sup>





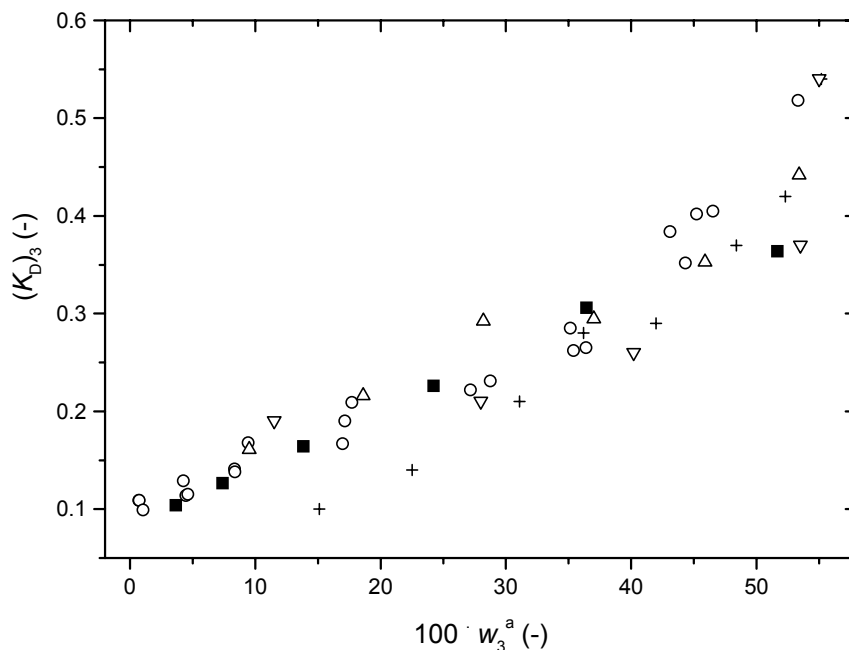
**Figure 2.10** Distribution ratio of caprolactam in the system toluene (1) + water (2) + caprolactam (3) at 40 °C as a function of the mass fraction of caprolactam in the aqueous phase at equilibrium: ■, automated workstation, this work; ○, jacketed glass cell, this work; +, Pajak *et al.*, 1991.<sup>17</sup>

**Table 2.2** Distribution ratios determined in the jacketed glass cell.

| $100w_3^a$ (-)              | $(K_D)_3$ (-) | $100w_3^a$ (-) | $(K_D)_3$ (-) | $100w_3^a$ (-) | $(K_D)_3$ (-) |
|-----------------------------|---------------|----------------|---------------|----------------|---------------|
| Toluene system <sup>a</sup> |               |                |               |                |               |
| 0.92                        | 0.110         | 17.9           | 0.158         | 50.5           | 0.262         |
| 1.05                        | 0.103         | 18.4           | 0.138         | 51.0           | 0.242         |
| 4.02                        | 0.120         | 27.8           | 0.154         | 51.8           | 0.302         |
| 4.46                        | 0.110         | 29.4           | 0.167         | 56.1           | 0.473         |
| 8.06                        | 0.122         | 39.2           | 0.189         | 56.5           | 0.464         |
| 8.89                        | 0.136         | 50.0           | 0.250         |                |               |
| Benzene system <sup>b</sup> |               |                |               |                |               |
| 0.71                        | 0.109         | 9.43           | 0.168         | 36.4           | 0.265         |
| 0.72                        | 0.109         | 17.0           | 0.167         | 43.1           | 0.384         |
| 1.04                        | 0.100         | 17.2           | 0.190         | 44.4           | 0.352         |
| 4.26                        | 0.129         | 17.7           | 0.209         | 45.2           | 0.402         |
| 4.47                        | 0.114         | 27.2           | 0.222         | 46.5           | 0.405         |
| 4.62                        | 0.115         | 28.8           | 0.231         | 53.3           | 0.518         |
| 8.33                        | 0.141         | 35.2           | 0.285         | 54.4           | 0.519         |
| 8.36                        | 0.138         | 35.4           | 0.262         |                |               |

<sup>a</sup> Toluene (1) + water (2) + caprolactam (3) at 40 °C

<sup>b</sup> Benzene (1) + water (2) + caprolactam (3) at 20 °C



**Figure 2.11** Distribution ratio of caprolactam in the system benzene (1) + water (2) + caprolactam (3) at 20 °C as a function of the mass fraction of caprolactam in the aqueous phase at equilibrium: ■, automated workstation, this work; ○, jacketed glass cell, this work; +, Morachevskii *et al*, 1960;<sup>18</sup> ▽, Tettamanti *et al*, 1960;<sup>19</sup> Δ, de Haan and Niemann, 2001.<sup>20</sup>

The repeatability of the measurements conducted on the automated workstation has been evaluated by determining the equilibrium distribution ratio of caprolactam in the toluene-water-caprolactam system seven times for the same initial caprolactam mass fraction in the aqueous phase. The results are shown in Table 2.3.

**Table 2.3** Repeatability of an equilibrium measurement conducted on the automated workstation for the toluene (1) + water (2) + caprolactam (3) system at 40 °C.

| Measurement | $100w_3^o$ (-)  | $100w_3^a$ (-) | $10(K_D)_3$ (-) |
|-------------|-----------------|----------------|-----------------|
| 1           | 1.86            | 14.2           | 1.31            |
| 2           | 1.90            | 14.5           | 1.31            |
| 3           | 1.89            | 14.2           | 1.33            |
| 4           | 1.92            | 14.0           | 1.37            |
| 5           | 1.86            | 14.3           | 1.30            |
| 6           | 1.85            | 14.1           | 1.31            |
| 7           | 1.90            | 14.5           | 1.31            |
| Average     | $1.88 \pm 0.03$ | $14.3 \pm 0.2$ | $1.32 \pm 0.02$ |

<sup>a</sup>The initial mass fraction of caprolactam in the aqueous phase  $w_3^{a,0}$  is 0.156.

The coefficient of variation of the seven measurements presented in Table 2.3 is 1.8%, which may be considered as very good repeatability. However, if statistical error analysis would be performed on those data, it would be found that measurement 4 exceeds the 2 times standard deviation range and hence may be characterised as a bad data point. Therefore, although the repeatability of the automated workstation may be characterised as good, one should be aware that bad data points might occur.

## 2.5 Conclusions

The workstation described in this work is a promising option for full automation of liquid-liquid equilibrium measurements. It performs all operations involved in these measurements, from initial solution preparation, through equilibrium establishment and sampling, to solute concentration analysis in both phases, with no need for any human assistance at all. Chemical analysis by gas or high-pressure liquid chromatography used on this workstation is also fully automated. Although these analytical techniques are rather demanding and require sample treatment before analysis itself, they are very often the best options, especially for multicomponent mixtures. In the configuration described in this work up to 65 equilibria can be measured continuously with no necessity for human interference. This is based on the need for one 2 ml vial for equilibrium establishment and two vials for each phase sample, and the presence of two 2 ml vial trays in the configuration. Up to 36 equilibrium experiments per day, compared to only 3 that could be done in a glass cell, in the case of the organic solvent-water-caprolactam system, can be accomplished using this workstation.

On the basis of the equilibrium measurements in the three test systems, toluene-water-acetone, toluene-water-caprolactam, and benzene-water-caprolactam, it is concluded that the measurements on the automated workstation are done with good accuracy, but also that they are easily repeatable.

By establishing equilibrium in 2 ml vials, as done here, not more than 4 ml of liquid waste per experiment (considering sample dilution as well) is produced. This amount is significantly lower than that generated in a jacketed glass cell experiment, which typically ranges from 30 ml up to 200 ml.

Although larger capital investments than in the case of a jacketed glass cell must be provided, the significant decrease in experimenter costs justifies such an investment. On the other hand, compared to the price of other systems with the same level of automation, this workstation is significantly cheaper. Furthermore, its compact size and possibility to be mounted on the top of a gas chromatograph do not ask for significant space. In the case described in this work, the whole workstation is operated in a laboratory room of 1.45 m by 1.32 m and 2.50 m in height.

However, certain limitations and issues to be improved are present:

(1) One of the limitations is that the system behaviour must be known before experiments are performed on the workstation. For example, the position of the phase boundary at equilibrium, the amount of each phase required for sampling or the degree of dilution must be determined beforehand.

(2) In some cases, when handling viscous liquids for example, an air bubble may form inside the syringe. This bubble is located at the surface of the plunger tip and is never larger than several percents of the syringe capacity. To overcome this shortcoming, an excess of 5  $\mu\text{l}$  of liquid is always sucked in the syringe, leaving the bubble inside the syringe after ejection. Furthermore, before performing experiments with such liquids, the rate of suction, the number of strokes and the rate of ejection are optimised to eliminate or to minimise the size of the bubble.

(3) Further optimisation can be done on the manner in which larger liquid volumes are transferred. Using an 80  $\mu\text{l}$  syringe for transfer of amounts up to 1 ml requires several repetitive cycles and therefore more time. Introducing more 2.5 ml dilutor syringes, such as the one used in this configuration for dilution of samples, would improve this operation.

(4) The agitation in the 2 ml vials performed in the orbital shaker also needs optimisation. A change of the vial shape, from a round into a square cross section, or introduction of a glass bead in the vial could improve the quality of mixing and accelerate the rate of equilibration.

(5) Furthermore, the temperature range of experiments could be broadened and not limited by room temperature, if cooling during agitation is also enabled.

(6) Finally, putting more shakers on the crossrail would allow more parallel measurements.

## Literature Cited

- (1) Ullmann, F. *Ullmann's Encyclopedia of Industrial Chemistry. Liquid-Liquid Extraction. Thermodynamic fundamentals. Measuring Methods of Phase Equilibrium*, 6th ed.; Wiley-Interscience: New York, 2002.
- (2) Raal, J. D.; Muhlbauer A. L. *Phase Equilibria. Measurements and Computation*; Taylor & Francis: Washington, 1988; pp. 97.
- (3) Tomtec. Products. Liquid Handling Workstations. <http://www.tomtec.com/Pages/Quadra230.html> (accessed Nov. 2002).
- (4) Hamilton Company. Products. Liquid Handling Robotics. Microlab AT Plus 2. <http://www.hamiltoncomp.com/product/sample/MLATplus2.html> (accessed Nov. 2002).
- (5) Peng, S. X.; Henson, C.; Strojnowski, M. J.; Golebiowski, A.; Klopfenstein, S. R. Automated High-Throughput Liquid-Liquid Extraction for Initial Purification of Combinatorial Libraries. *Anal. Chem.* **2000**, *72*, 261-266.
- (6) Zhang, N.; Hoffman, K. L.; Li, W.; Rossi D. T. Semi-Automated 96-Well Liquid-Liquid Extraction for Quantitation of Drugs in Biological Fluids. *J. Pharm. Biomed. Anal.* **2000**, *22*, 131-138.
- (7) Bolden, R. D.; Hoke, S. H. II; Eichhold, T. H.; McCauley-Myers, D. L.; Wehmeyer K. R. Semi-Automated Liquid-Liquid Back-Extraction in a 96-Well Format to Decrease Sample Preparation Time for the Determination of Dextromethorphan and Dextrorphan in Human Plasma. *J. Chromatogr. B* **2002**, *772*, 1-10.
- (8) Ruddick, C. Automation of Liquid-Liquid Extraction Processes. *Chim. Oggi.* **2001**, *19*, 40-43.
- (9) Mettler Toledo AutoChem. Purification & Work-up. Allex. <http://www.bohdan.com/allex-about.htm> (accessed Nov. 2002).
- (10) Mettler Toledo AutoChem. Purification & Work-up. Alexis. <http://www.bohdan.com/allex-about.htm> (accessed Nov. 2002).
- (11) *Laboratory Robotics Handbook*; Zymark Corporation, Hopkinton, MA, 1988.
- (12) Meab Metallextraktion AB. Equipment. The Akufve and H-centrifuge systems. <http://www.meab-mx.se/en/index.htm> (accessed Nov. 2002).
- (13) Carlsson, K.; Karlberg, B. Determination of Octanol-Water Partitioning Coefficients Using a Micro-Volume Liquid-Liquid Flow Extraction System. *Anal. Chim. Acta* **2000**, *423*, 137-144.
- (14) CTC Analytics. GC Products. Combi PAL. [www.ctc.ch/f\\_combi\\_pal.htm](http://www.ctc.ch/f_combi_pal.htm) (accessed Sept. 2002).
- (15) DECHEMA. Forschung und Innovation. Fachkompetenzen und Ansprechpartner. Portal Extraktion Test-Systeme für die Flüssigextraktion. <http://www.dechema.de/f-forschung.htm> (accessed Jan. 2003).
- (16) Misek, T.; Berger, R.; Schröter, J. *Standard Test Systems for Liquid Extraction*. European Federation of Chemical Engineering. Working Party on Distillation, Absorption and Extraction. The Institution of Chemical Engineers: Rugby, 1985.
- (17) Pajak, M.; Piotrowicz, J.; Skrzypinski, W. Extractive Equilibria in Technology of Caprolactam Production. *Przemysl Chemiczny* **1991**, *70*, 72-74.
- (18) Morachevskii, A. C.; Sabinin, V. E. Solubility Diagrams for the Ternary Systems Caprolactam-Water-Benzene, Caprolactam-Water-Carbon Tetrachloride and Caprolactam-Water-Dichloroethane. *J. App. Chem. (USSR)* **1960**, *33*, 1775-1779.
- (19) Tettamanti, K.; Nogradi, M.; Sawinsky, J. Equilibria of the Ternary System Caprolactam /Water/ Organic Solvent, in the Liquid State. *Period. Polytech. Chem. Eng.* **1960**, *4*, 201-218.
- (20) de Haan, A. B.; Niemann, S. H. Modelling Phase Equilibria in Industrial Caprolactam Recovery from Aqueous Ammonium Sulphate Solutions with Benzene. *Solvent Extraction for the 21<sup>st</sup> Century. Proceedings of ISEC '99. Vol. 2*. Edited by Cox, M.; Hidalgo, M.; Valiente, M.; Society of Chemical Industry: London, 2001, 1537-1542.



## Chapter 3

# Reactive extraction of aldehydes and ketones

### 3.1 Introduction

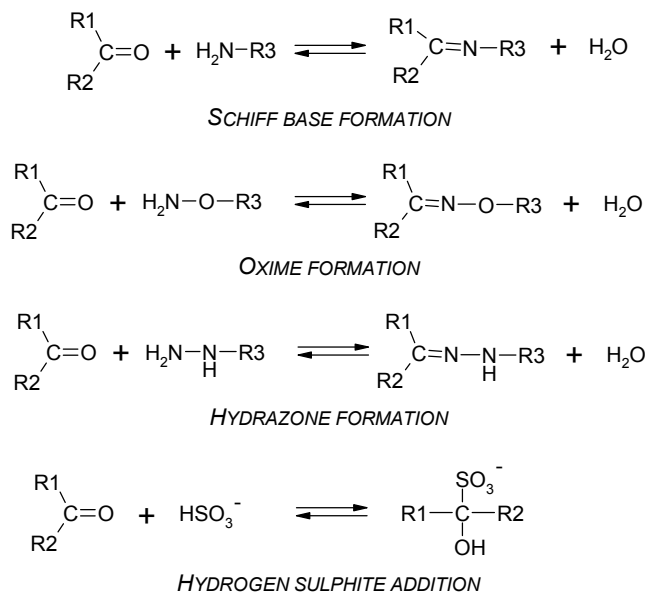
There are several reports on the use of chemical reactions for performing or improving the recovery/separation of aldehydes and ketones (carbonyl compounds). Such approach is applied to perform a recovery or separation by using ion-exchange membranes,<sup>1</sup> adsorption on a polymeric reagent,<sup>2</sup> or electrophoresis.<sup>3</sup> However, no examples in the field of extraction are reported.

In this chapter, we evaluate the use of aqueous solutions containing salts able to react reversibly with carbonyl groups, for the reactive extraction of aldehydes or ketones from an apolar organic solvent. Several such salts of different type and with systematic variations in structure are considered for the recovery of benzaldehyde from toluene; cyclohexanone from cyclohexane; and 2-hexanone, 3-hexanone, or hexanal from n-hexane. In this way, the influence of the salt type and structure on the extraction performance, as well as the differences in extractability of aromatic, cycloaliphatic, and linear aliphatic carbonyls, but also between various structural carbonyl isomers, can be established.

The equilibrium distribution of these carbonyl compounds between the aqueous and organic phases was measured as a function of the initial salt concentration to evaluate the capacities of these aqueous salt solutions. The influence of the salts on the solubility of each organic solvent in water and on the solubility of water in each organic solvent was also measured. This allows for the determination of both selectivity and loss of extraction solvent. Furthermore, by measuring the influence of the temperature on the equilibrium distribution, the feasibility of back-extraction of the extracted carbonyl compounds by a shift in temperature was evaluated. An equilibrium model was used to determine the physical interaction coefficients and reaction equilibrium constants by fitting of the experimental results.

### 3.2 Chemical reactions for reactive extraction of carbonyls

Several reversible chemical reactions based on the nucleophilic addition mechanism characteristic of carbonyl groups are evaluated for use in reactive extraction. These are Schiff base formation, hydrazone formation, and hydrogen sulphite addition (Figure 3.1).<sup>4,5</sup>



**Figure 3.1** Characteristic reactions of carbonyl compounds.

Hydrogen sulphite addition can be readily used for this purpose, but to use the Schiff base formation or hydrazone formation, the R3 group (Figure 3.1) has to be an ionic hydrocarbon tail. As a result, both extractant and extraction product are going to be salts.

Therefore, some suitable and commercially available amino, hydrazine, and hydrogen sulphite salts are evaluated. They are listed in Table 3.1.

The criterion for the selection of an amino salt is that the salt and the extraction product are insoluble in the organic solvent, but as soluble in water as possible. Also care is taken that salt costs are acceptable and that there is minor impact of the salt on the environment. Generally, salts, as charged molecules, are completely insoluble in apolar organic solvents, but as the molecular weight increases, the solubility increases in the apolar phase and decreases in water. To prevent this effect, the hydrocarbon tail R3 should be small. Therefore, sodium glycinate is chosen as a low-molecular-weight amino salt, which is also a commercially available, inexpensive, and environmentally acceptable compound. The other amino salts shown in Table 3.1 are used to explore the differences between carboxylic and sulphonic groups present in the tail and between aryl and alkyl hydrocarbon tails, as well as the influence of the alkyl chain length in the tail. Girard's reagents are selected as the most known and applied hydrazine reagents.<sup>6</sup> Again, the difference between an aliphatic tail (Girard's reagent T) and an aromatic tail (Girard's reagent P) is investigated. Because sodium is present as the cation in all amine salts, it is used for the hydrogen sulphite salt as well.

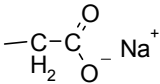
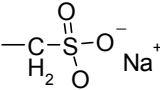
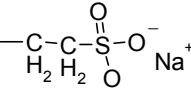
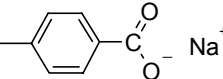
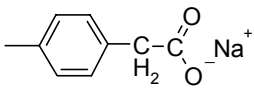
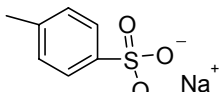
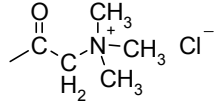
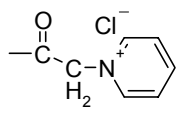
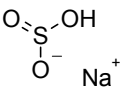
Salts exhibiting oxime formation are not evaluated because of their poor commercial availability. Nevertheless, the results obtained for hydrazone salts are expected to be indicative for oximes. This assumption is based on the similar characteristics of the oxygen (oxime) and nitrogen (hydrazone) atoms that are bonded to the primary amino group, as well as on literature reports.<sup>4</sup>

### 3.3 Model

The phase and reaction equilibria in the described extraction system are schematically shown in Figure 3.2. Partitioning of the salt (*Salt*) and the extraction product (*Carb·Salt*) between the organic and aqueous phases is neglected because they are both assumed to be completely insoluble in the apolar organic solvent (*ApOrgSol*).



**Table 3.1.** Salts evaluated as carbonyl extractants.

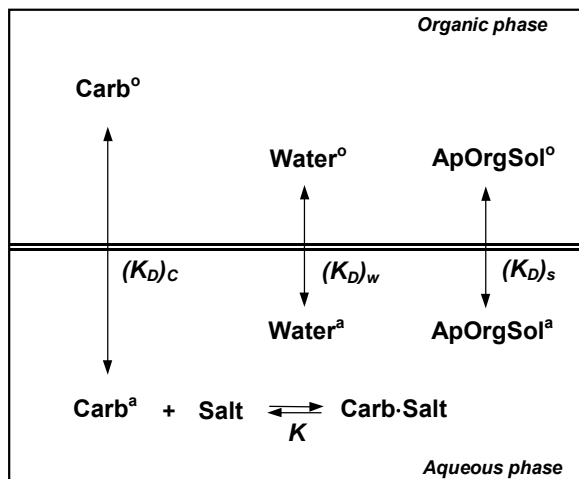
| Salt  | Structural formula  |
|---|---|
| Alkyl amine salts (H <sub>2</sub> N-R3)                         | R3  |
| Sodium glycinate  |     |
| Sodium amino methanesulfonate                                   |     |
| Sodium taurinate  |     |
| Aryl amine salts (H <sub>2</sub> N-R3)                          | R3  |
| Sodium p-aminobenzoate  |     |
| Sodium 4-aminophenyl acetate                                    |     |
| Sodium sulfanilate  |    |
| Alkyl hydrazine salt (H <sub>2</sub> N-NH-R3)                   | R3  |
| Carbazoylmethyl-trimethylammonium chloride (Girard's reagent T) |   |
| Aryl hydrazine salt (H <sub>2</sub> N-NH-R3)                    | R3  |
| 1-(carbazoylmethyl)pyridinium chloride (Girard's reagent P)     |   |
| Hydrogen sulphite adduct formation salt                         |   |
| Sodium hydrogen sulphite  |  |

$(K_D)_i$  represents the physical distribution ratio of partitioning species  $i$ , given by:

$$(K_D)_C = \frac{c_{\text{Carb}}^a}{c_{\text{Carb}}^o}, (K_D)_W = \frac{c_{\text{Water}}^a}{c_{\text{Water}}^o}, (K_D)_S = \frac{c_{\text{ApOrgSol}}^a}{c_{\text{ApOrgSol}}^o} \quad (3-1)$$

and  $K$  defines the carbonyl-salt reaction equilibrium constant assuming the stoichiometry shown in Figure 3.2:

$$K = \frac{c_{\text{Carb} \cdot \text{Salt}}}{c_{\text{Carb}}^a \cdot c_{\text{Salt}}} \quad (3-2)$$



**Figure 3.2** Scheme of reactive extraction of a carbonyl (*Carb*) using an aqueous salt solution as the extraction solvent.

If, in addition to the carbonyl-salt complex, water is also produced, as in the Schiff base, hydrazone, or oxime formation approaches (see Figure 3.1), and if the reaction is performed in an aqueous medium (so that the water concentration can be assumed constant), then this definition of the reaction equilibrium constant can still be used, but in that case  $K$  represents the true equilibrium constant,  $K'$ , divided by the concentration of water  $c_{H_2O}^a$ :

$$K = \frac{K'}{c_{H_2O}^a} = \frac{c_{Carb-Salt}}{c_{Carb}^a \cdot c_{Salt}} \quad (3-2a)$$

The overall equilibrium, as a consequence of physical and reaction equilibria, is expressed through the overall distribution ratio of the carbonyl compound ( $D_C$ ):

$$D_C = \frac{c_{Carb}^o + c_{Carb-Salt}}{c_{Carb}^a} \quad (3-3)$$

This parameter represents the distribution of the carbonyl compound between the two phases in all of its forms.

Many detailed thermodynamic models, such as the Pitzer<sup>7</sup> or Chen electrolyte NRTL models<sup>8,9</sup> based on activity coefficients, or even models based on the equation of state<sup>10</sup> are available and could be used to describe the physical equilibrium in electrolyte systems expressed through  $(K_D)_i$ . Also, the reaction equilibrium constant  $K$  could be expressed via activities rather than concentrations, especially in systems containing electrolytes. However, the scope of this work was the exploration of the applicability of aqueous salt solutions for use as reactive extractants rather than detailed thermodynamic modelling. Therefore, we limited ourselves on the description of the equilibria by a simple model with as few parameters as possible. This is done by assuming the reaction constant  $K$  to be independent of the salt concentration, and using the empirical Setschenow equation<sup>11</sup> for the description of the physical distribution constant  $(K_D)_c$ . This equation describes the solubility of molecular species  $i$  in an electrolyte solution ( $c_i$ ) as a function of the solubility of that solute in pure water ( $c_i'$ ) and the salt concentration in the electrolyte solution ( $c_{salt}$ ) using a single parameter ( $k_S$ ):

$$\log\left(\frac{c_i'}{c_i}\right) = k_S \cdot c_{salt} \quad (3-4)$$

Although equation (3-4) should be extended to include the interactions of solute molecules with each other,<sup>11</sup> this is not required when the concentration of the solute in water is low.

Equation (3-4) is also valid for the partitioning of a solute between aqueous and organic phases, if the equilibrium concentration in the organic phase in both cases (pure water/organic phase and electrolyte solution/organic phase) is the same. Therefore, the physical distribution ratio of the carbonyl between the aqueous salt solution and the organic phase  $[(K_D)_C]$  can be expressed as a function of the initial salt concentration in water ( $c_{salt}^0$ ), the Setschenow parameter ( $k_S$ ), and the physical distribution ratio between pure water and the organic phase  $[(K_D)'_C]$  as:

$$(K_D)_C = \frac{(K_D)'_C}{10^{k_S \cdot c_{salt}^0}} \quad (3-5)$$

The actual salt concentration ( $c_{salt}$ ) in the aqueous phase is assumed to be constant and equal to the initial salt concentration ( $c_{salt}^0$ ). This assumption is valid when 1 mol of salt produces 1 mol of extraction product, assuming that the product has the same physical effect on the organic solutes as the extracting salt.

On the other hand, by combining equations (3-1) - (3-3) and applying mass balance [the volumes of the aqueous ( $V_{aq}$ ) and organic ( $V_{org}$ ) phases are taken to be equal], the overall carbonyl equilibrium distribution ratio  $D_C$  can be implicitly expressed as:

$$D_C = (K_D)_C + K \cdot (K_D)_C \cdot \left[ c_{salt}^0 - c_{Carb}^0 \left( 1 - \frac{(K_D)_C + 1}{D_C + 1} \right) \right] \quad (3-6)$$

The introduction of equation (3-5) into equation (3-6) gives a mathematical description of the overall carbonyl equilibrium in the system as a function of the initial salt concentration in water ( $c_{salt}^0$ ) for the known initial concentration of carbonyl in the organic phase ( $c_{Carb}^0$ ):

$$D_C = \frac{(K_D)'_C}{10^{k_S \cdot c_{salt}^0}} \left\{ 1 + K \cdot \left[ c_{salt}^0 - c_{Carb}^0 \left( 1 - \frac{(K_D)'_C + 10^{k_S \cdot c_{salt}^0}}{10^{k_S \cdot c_{salt}^0} \cdot (D_C + 1)} \right) \right] \right\} \quad (3-7)$$

The Setschenow parameter ( $k_S$ ) and the physical distribution constant for no-salt conditions  $[(K_D)'_C]$  characterise the physical effect of the salt, whereas the reaction equilibrium constant ( $K$ ) characterises the chemical effect of the salt.

## 3.4 Experimental section

### 3.4.1 Chemicals and solution preparation

Benzaldehyde (purity 99%), toluene (purity 99%), Girard's reagent P (purity >98%), Girard's reagent T (purity >99%), and sodium sulfanilate dihydrate (purity >98%) were supplied by Merck (Germany), sodium glycinate hydrate (purity 99%), sodium p-aminobenzoate (purity 99%) and dibenzofuran (purity 98%) by Acros Organics (Belgium) and sodium hydrogen sulphite (purity >99%) by Sigma-Aldrich (USA). The chemicals were used as received. MiliQ water was used in all experiments.

Aqueous solutions of sodium taurinate, sodium aminomethane sulfonate and sodium 4-aminophenyl acetate were prepared by dissolving taurine (purity >99%, Aldrich USA), aminomethanesulphonic acid (purity 97%, Aldrich USA) or 4-aminophenyl acetic acid (purity >97%, Merck Germany) in water and adding solid sodium hydroxide (purity >99%, Merck Germany) to generate the required salt solutions. The amount of added sodium hydroxide depended on the amount of acid and its dissociation constant pKa. This amount

had to be sufficient to generate a high enough pH to obtain at least 99.9% of salt with an unprotonated amino group. Because only such unprotonated amino groups will react with carbonyls, the pH of all other prepared ammonium derivative salt solutions was measured to confirm that the amino group in them was also unprotonated.

All aqueous salt solutions were prepared as nearly saturated solutions at room temperature. The water solubility data for most of the salts found in the literature were only qualitative ("soluble" or "larger than") or could not be found at all. Therefore, each salt was added to water until no more could be dissolved. Then, a small amount of water was added until all of the solids dissolved.

Organic solutions were made by dissolving the carbonyl compound in an adequate apolar organic solvent. The concentration of the carbonyl compound was kept at around 1.5 wt% for all solutions. This concentration was taken as the reference and represents the benzaldehyde concentration in the range of interest for the industrial toluene oxidation process when all three products, benzoic acid, benzaldehyde and benzyl alcohol are produced in equal quantities (see Chapter 1).

### 3.4.2 Equilibrium experiments

Experiments were performed on the automated workstation for liquid-liquid equilibrium measurements which is described in detail in Chapter 2. The extraction was done in closed 2-ml glass vials, in which 12  $\mu\text{l}$  of a carbonyl compound, 888  $\mu\text{l}$  of organic solvent, and 900  $\mu\text{l}$  of aqueous phase were introduced. The aqueous phase was made by introducing saturated salt solutions and pure milliQ water in different volume ratios. After being filled, the vials were agitated by applying 750 rotations per minute, with 30 s of rotation in one direction, 5-s pause and 30 s of rotation in the opposite direction. The time of shaking required to reach equilibrium was determined for each system prior to the equilibrium experiments. After being agitated, the vials were transferred into thermostated metal trays and a settling time of at least 1 h, which had been verified to be sufficient, was allowed. Following the settling, 60- $\mu\text{l}$  samples of both phases were taken. The samples were withdrawn from the top using needle penetration speeds of 800  $\mu\text{m/s}$  and liquid suction rates of 1.5  $\mu\text{l/s}$ . Each sample was transferred into an empty 2-ml vial and diluted with 540  $\mu\text{l}$  of ethanol. This dilution was done to enable sample analysis, but also to prevent possible formation of a second phase as a result of a temperature change. Twenty microliters of the internal standard solution was added. The vials were transferred into the shaker, agitated for 3 min, and left to settle for 10 min. Next, a sample was injected into the gas chromatograph (GC) for quantitative analysis. It is important to emphasise that, before any liquid transfer, the syringe was washed in ethanol.

The distribution ratio of the carbonyl compound was calculated either by dividing the measured concentration in the aqueous with that measured in the organic phase or by using the measured concentration in the organic phase and the mass balance to calculate the aqueous-phase concentration. The first option was applied when pure water was the solvent, because in that case there was no chemical reaction and it was possible to measure the total concentration of the carbonyl in the aqueous phase using the analytical method employed. These measurements were used to verify satisfaction of the mass balance. Depending on the system, it was found that the mass balance was fulfilled with an error of 0.5-2.5%. The distribution ratio of the apolar organic solvent was calculated from the measured concentration in the aqueous phase.

### 3.4.3 Chemical analysis

The components were quantified by a Varian GC CP-3800 system equipped with a capillary CP-FFAP-CP column (25 m · 0.15 mm; 0.25- $\mu$ m packing) and an FID detector. During the analysis, the column temperature was raised from 100 to 230 °C in increments of 17.5 °C/min and, at the end, was maintained at 230 °C for 1 min. The temperatures of the detector and injector were kept constant at 300 and 275 °C, respectively, with a pressure in the injector of 276 kPa and a split ratio of 60. Hydrogen was used as the carrier gas with an initial flow of 1.5 ml/min. A sample of 1.5  $\mu$ l was injected into the column for analysis. Quantification of the components in the sample was done by using an internal standard method with 0.25 M solution of dibenzofuran in ethanol used as the internal standard.

A sample of known concentration of benzaldehyde in toluene was analysed 25 times to determine the repeatability of the GC analysis. A relative percentage standard deviation (coefficient of variation) of 1.8% was found.

The Karl Fischer method, modified for analysis of samples containing carbonyl compounds, was used to determine the water concentration in the organic phase.

### 3.4.4 Data analysis

The fitting of the experimental results was done in Microcal Origin (Microcal Software, USA) using equation (3-7). The solution was obtained by minimising the sum of squares of the deviations of the fitting curve from the experimental points. The unknown reaction equilibrium constant ( $K$ ) and Setschenow parameter ( $k_S$ ) were varied for a known initial salt concentration in the aqueous phase ( $c_{Salt}^0$ ), the initial concentration of the carbonyl compound in the organic phase ( $c_{Carb}^0$ ) and the physical distribution coefficient of a carbonyl in the pure water-organic solvent system [ $(K_D)'_c$ ].

## 3.5 Results and Discussion

### 3.5.1 Equilibration time

Prior to the equilibrium measurements, the time required to reach equilibrium for specific experimental conditions and different salt solutions was determined. Therefore, the change in concentration of the carbonyl compound in the organic phase as a function of time is monitored for all eight salt solutions and pure water. The salt solutions were at their highest prepared concentrations.

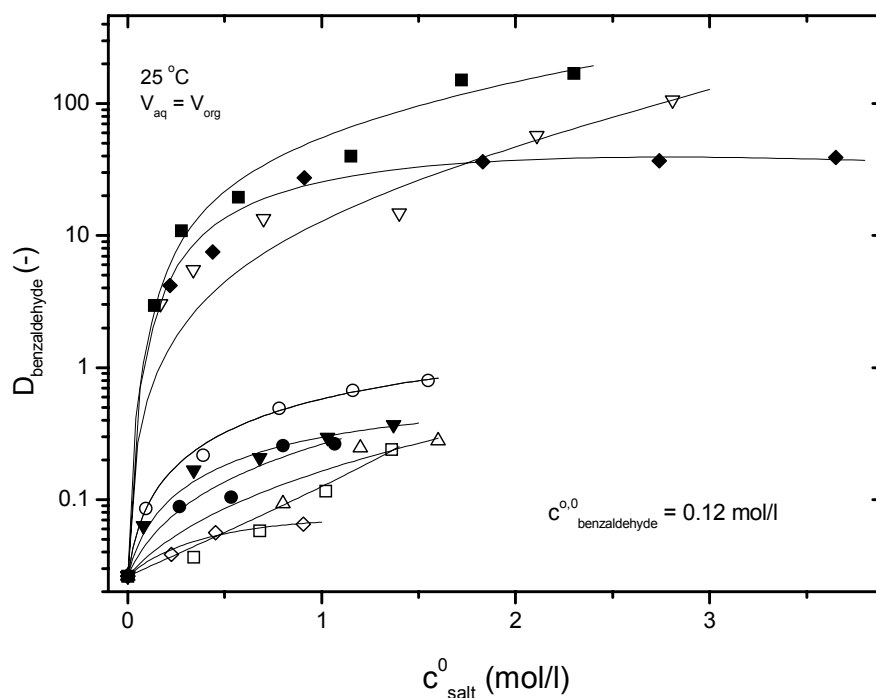
For the extraction of benzaldehyde from toluene, equilibrium is reached after 1000 min of mixing in all cases. Therefore, this time was adopted as the time of mixing required to reach equilibrium for extraction of benzaldehyde. The results were obtained at 25 °C and were found to be applicable for higher temperatures as well. For extraction of the other evaluated carbonyl compounds, a mixing time of 720 min was found to be sufficient. It should be remarked that the longest equilibration time was noted for Girard's reagents, whereas the equilibration time was much shorter and more or less similar for all other solutions.

Furthermore, it should be emphasised that the required long equilibration time was a consequence of the relatively poor mixing behaviour in the orbital shaker. For comparison, the equilibrium in benzaldehyde extraction could be reached in less than 60 min of mixing for all systems when an agitated vessel equipped with a magnetic stirring bar and high rotation speeds were used.

### 3.5.2 Effect of salt type and structure on equilibrium distribution ratio of benzaldehyde

The extraction of benzaldehyde from toluene is used here to discuss the effect of the type and structure of the applied salts on the extraction performance. The differences between various carbonyl compounds are addressed later in the chapter.

Figure 3.3 shows the equilibrium distribution ratio of benzaldehyde as a function of the initial salt concentration for different salts. The experimental data are shown as points and the lines represent the model fits. The values of the reaction equilibrium constants and Setschenow parameters obtained by fitting the experimental data are listed in Table 3.2. At this point, it should be emphasised that the experimental data could not be described properly by a model that neglected the physical effects of the salt (described by Setschenow parameter  $k_s$ ). In particular, the data in the region of higher salt concentrations where physical effects are dominant would not be fitted well. If  $k_s$  were taken to be zero, then all of the curves would have an equal positive slope in this region (on a  $\log D-C_{salt}^0$  scale), and behaviour like reaching a constant value (in the case of sodium hydrogen sulphite), for example, could not be predicted.



**Figure 3.3** Equilibrium distribution ratio of benzaldehyde as a function of the initial salt concentration in aqueous solutions of (●) sodium glycinate, (■) Girard's reagent P, (▽) Girard's reagent T, (◇) sodium sulfanilate, (○) sodium taurinate, (□) sodium aminomethane sulfonate, (◆) sodium hydrogen sulphite, (Δ) sodium p-amino benzoate, and (▼) sodium 4-aminophenyl acetate.

It is clear that all evaluated salts did cause an enhancement of the benzaldehyde distribution compared to the pure water case. Nevertheless, orders of magnitude differences exist between the amines, on one hand, and the hydrogen sulphite and hydrazine salts, on the other. In the first case, the distribution ratio increase varies from 3 to 40 times, whereas in the latter case, it is 1000 times for hydrogen sulphite and up to 10000 times for the hydrazine salts.

**Table 3.2.** Reaction equilibrium constant ( $K$ ) and Setschenow parameters ( $k_S$ ) for the interaction of different carbonyls and various salts at 25 °C.

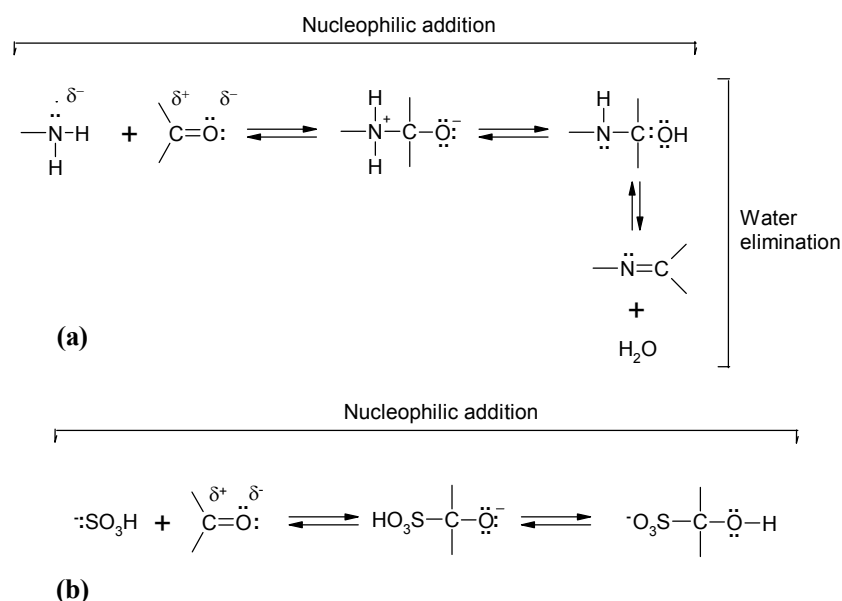
| Compound                      | $K$ (l/mol)                | $k_S$ (l/mol)    |
|-------------------------------|----------------------------|------------------|
| Sodium hydrogen sulphite      |                            |                  |
| Benzaldehyde                  | $(1.6 \pm 0.2) \cdot 10^3$ | $0.16 \pm 0.02$  |
| Cyclohexanone                 | $(1.4 \pm 0.1) \cdot 10^3$ | $0.26 \pm 0.01$  |
| 2-Hexanone                    | $(1.6 \pm 0.5) \cdot 10^1$ | $0.11 \pm 0.04$  |
| 3-Hexanone <sup>a</sup>       | $(1.1 \pm 0.0) \cdot 10^1$ | $0.18 \pm 0.00$  |
| Hexanal                       | $(7.2 \pm 0.9) \cdot 10^3$ | $0.53 \pm 0.04$  |
| Girard's reagent T            |                            |                  |
| Benzaldehyde                  | $(3.1 \pm 0.9) \cdot 10^2$ | $-0.25 \pm 0.05$ |
| Cyclohexanone                 | $(3.9 \pm 0.9) \cdot 10^1$ | $-0.03 \pm 0.03$ |
| 2-Hexanone                    | $(3.6 \pm 0.8) \cdot 10^1$ | $0.13 \pm 0.04$  |
| 3-Hexanone                    | $(2.0 \pm 0.3) \cdot 10^1$ | $0.24 \pm 0.04$  |
| Hexanal                       | $(1.5 \pm 0.1) \cdot 10^3$ | $0.36 \pm 0.02$  |
| Girard's reagent P            |                            |                  |
| Benzaldehyde                  | $(1.9 \pm 0.9) \cdot 10^3$ | $-0.1 \pm 0.1$   |
| Cyclohexanone                 | $(8 \pm 2) \cdot 10^1$     | $0.05 \pm 0.05$  |
| 2-Hexanone                    | $(4 \pm 1) \cdot 10^1$     | $0.00 \pm 0.06$  |
| 3-Hexanone <sup>a</sup>       | $(8.7 \pm 0.0) \cdot 10^1$ | $0.27 \pm 0.00$  |
| Hexanal                       | $(2.4 \pm 0.3) \cdot 10^3$ | $0.54 \pm 0.05$  |
| Sodium p-amino benzoate       |                            |                  |
| Benzaldehyde <sup>a</sup>     | $4 \pm 3$                  | $-0.1 \pm 0.2$   |
| Cyclohexanone                 | $0.7 \pm 0.3$              | $0.16 \pm 0.06$  |
| Sodium sulfanilate            |                            |                  |
| Benzaldehyde                  | $3.7 \pm 0.8$              | $0.26 \pm 0.09$  |
| Cyclohexanone                 | $0.0 \pm 0.5$              | $-0.1 \pm 0.2$   |
| Hexanal <sup>a</sup>          | $2.2 \pm 0.0$              | $-0.44 \pm 0.00$ |
| Sodium 4-aminophenyl acetate  |                            |                  |
| Benzaldehyde                  | $(1.4 \pm 0.2) \cdot 10^1$ | $0.13 \pm 0.06$  |
| Cyclohexanone                 | no reaction                | $0.18 \pm 0.02$  |
| Sodium taurinate              |                            |                  |
| Benzaldehyde                  | $(2.6 \pm 0.3) \cdot 10^1$ | $0.07 \pm 0.03$  |
| Cyclohexanone                 | no reaction                | $0.24 \pm 0.03$  |
| Hexanal <sup>a</sup>          | $(2.0 \pm 0.0) \cdot 10^1$ | $0.09 \pm 0.00$  |
| Sodium glycinate              |                            |                  |
| Benzaldehyde                  | $8 \pm 4$                  | $-0.1 \pm 0.2$   |
| Cyclohexanone                 | no reaction                | $0.22 \pm 0.02$  |
| Hexanal                       | $9.8 \pm 5.7$              | $-0.5 \pm 0.3$   |
| Sodium aminomethane sulfonate |                            |                  |
| Benzaldehyde                  | $1 \pm 2$                  | $-0.5 \pm 0.4$   |
| Cyclohexanone                 | no reaction                | $0.25 \pm 0.05$  |
| Hexanal <sup>a</sup>          | $8.9 \pm 0.0$              | $-0.10 \pm 0.00$ |

<sup>a</sup> Good fit occurs because too few experimental data exist.

The magnitude of the chemical effect of a salt (to emphasise again, the chemical effect refers to the chemical reaction equilibrium) can easily be deduced from the graph in Figure 3.3 by observing the curve in the slope in the region of low salt concentrations (around 0.12 mol/l). As this slope increases, the reaction equilibrium is more shifted to the right.

The trend of the curve in the region of maximum evaluated salt concentration characterises the type and magnitude of the physical effect (salting-out or salting-in) of the salt. However, the conclusions, even about the type of effect, cannot as readily be drawn from the graph. If the slope in this region is equal to or less than zero, then it can be said with certainty that salting-out occurs. However, a positive slope does not provide a unique answer, as it can be present either for salting-out, when there is no physical effect, or for salting-in. Therefore, it is best to make a conclusion about the type of effect from the signs of the Setschenow constants  $k_s$  determined by fitting (Table 3.2). Positive values indicate salting-out and negative salting-in. Although the value of  $k_s$  also expresses the intensity of the physical effect, for accurate quantitative characterisation more measurements in the region of the higher salt concentrations would be preferable. Therefore, the values presented in Table 3.2 should be taken more for characterisation of the type of effect rather than for characterisation of its intensity.

It can be seen from the results that sodium hydrogen sulphite exhibits one of the strongest chemical effects among the evaluated salts. The generation of water in the reaction of any ammonium derivative with a carbonyl (see Scheme 3.1), which causes the reaction equilibrium to shift significantly toward the reactants if the reaction is performed in the aqueous phase, results in the generally poorer performance of the ammonium derivatives. The elimination of water does not occur in the case of hydrogen sulphite, allowing for good conversion to the product even in an aqueous medium.



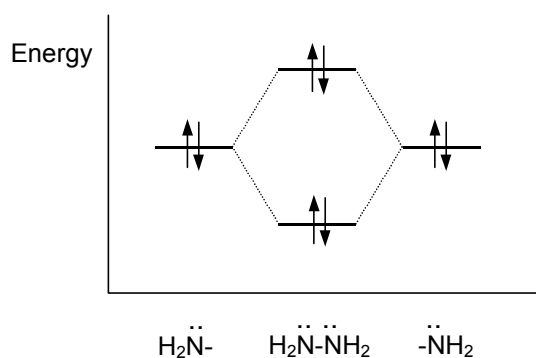
**Scheme 3.1** Reaction mechanism of carbonyl compounds with (a) ammonia derivatives and (b) hydrogen sulphites (b).<sup>12</sup>

However, although the chemical effects of the hydrogen sulphite and hydrazines are similar, the weak salting-in effect noticed for hydrazines and the salting-out effect of hydrogen sulphite resulted in a higher maximum value of the distribution ratio reached with hydrazines than with the hydrogen sulphite. This kind of physical action fits with a general trend according to which small ions act as salting-out agents, whereas large ones tend to salt-in.<sup>13</sup>



The aryl hydrazine salt exhibited somewhat stronger chemical effect than the alkyl one, whereas it seems that the alkyl salt salts-in the carbonyls more (see Figure 3.3, and also Figure 3.6 below).

Even though, both hydrazines and amines have the same nucleophilic center (see Scheme 3.1), a large difference in chemical effects was found. The existence of such difference is in agreement with reports in the literature, where it is pointed out that the overall equilibrium in the reaction with amines greatly favours hydrolysis, in contrast to the reaction with hydrazines in which condensation is more favorable.<sup>4,14</sup> Hydrazine salts are weaker bases than amines,<sup>15,16,17</sup> which might lead to the conclusion that they are worse nucleophiles. However, because of the so-called alpha effect, they are much better nucleophiles than amines.<sup>18</sup> If there is an atom with a lone electron pair bonded to the reactive amino group, such as the neighbouring nitrogen atom in the hydrazine, then the two existing lone pairs will interact (see Figure 3.4). Although an interaction exists, no net bonding occurs because both bonding and antibonding orbitals are filled. However, the energy of the highest occupied molecular orbital (HOMO) is now higher than it would be if no second lone pair were present, as in an amine. Because a nucleophile reacts by means of its highest occupied molecular orbital, the compound with the higher-energy HOMO will be a better nucleophile and will generate more thermodynamically stable C=N linkages.



**Figure 3.4** Alpha effect characteristic of hydrazines.

In addition, as stronger acids, the hydrazine derivatives cause more extensive protonation of the carbonyl group. This also improves the chemical performance since a protonated carbonyl group reacts better with nucleophiles than an unprotonated one.<sup>18</sup>

Although it is known that aliphatic amines build more stable C=N bonds than aromatic ones,<sup>14</sup> we cannot make such a general conclusion in this case. If we order the amines according to the values of  $K$  obtained, we see no regularity based simply on the presence of an aryl or alkyl group. The effect of a terminating sulfonic or carboxylic group must be considered together with the effect of an alkyl or aryl group. Therefore, if we compare an aromatic with an aliphatic amine salt of similar structure (in terms of terminating group and its distance from the reacting center), then we can see only the influence of aryl and alkyl groups. However, when  $K$  values are compared for the reactions of sodium aminomethane sulfonate and sodium sulfanilate or for the reactions of sodium glycinate and sodium *p*-amino benzoate, the differences are negligible (see Table 3.2). Therefore, on the basis of only these results, even including those for other carbonyls, it is not possible to determine whether, in general, aromatic amino salts have stronger chemical effects on carbonyls than aliphatics, as was the case for amines.

The effect of the strong electron-withdrawing sulfonic and somewhat weaker carboxylic group on the reacting center seems to be significant. If the sulfonic group is further away from the amino group, as in sodium taurinate compared to sodium amino methane sulfonate,

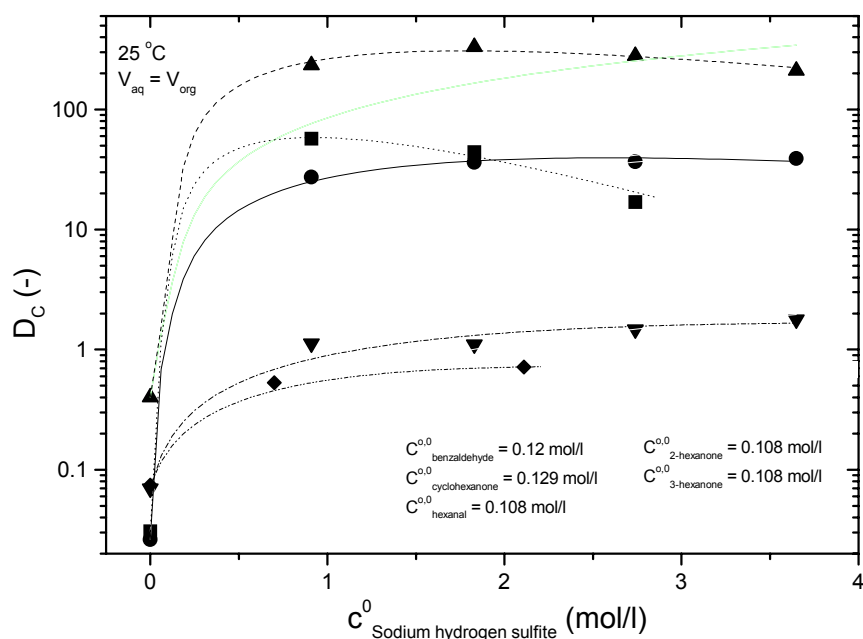
$K$  is noticeably higher. The same effect, but weaker, can be seen when comparing sodium 4-aminophenyl acetate with sodium *p*-amino benzoate. The weaker withdrawing effect of the carboxylic group results in the carboxylate salts having higher  $K$  values than the comparable sulfonates: sodium glycinate than sodium amino methane sulfonate, as well as sodium *p*-amino benzoate than sodium sulfanilate.

One can clearly see that electron-withdrawing effects of these two groups exist and are different in intensity by comparing the basicity of the amino group in, for example, sodium glycinate and sodium amino methane sulfonate to that of the amino group in ethylamine. The first has a carboxylic group, the second a sulfonic group and the third a  $\text{CH}_3$  group as the terminating group. The strongest base is ethylamine ( $\text{p}K_{\text{a}} = 10.7$ ), glycinate is somewhat weaker ( $\text{p}K_{\text{a}} = 9.8$ ), and the sulfonic group makes amino methane sulfonate a significantly weaker base ( $\text{p}K_{\text{a}} = 5.8$ ).<sup>15</sup> Furthermore, when the sulfonic or carboxylic group is moved further away from the amino center, the influence of the withdrawing effect diminishes, and the basicity of the amino group increases. For example, the  $\text{p}K_{\text{a}}$  of amino ethane sulfonate is 9.0, that of propane sulfonate is 10.0 and that of pentane sulfonate is 11.0.<sup>15,17</sup> Therefore, we can conclude that, by putting the terminating carboxylic or sulfonic group as far from the reacting center as possible, its negative influence on the chemical effect of a salt should decrease. Furthermore, if in place of a carboxylic or sulfonic group, a charged terminating group with an electron-donating effect were introduced, it could even enhance the chemical effect of the salt.

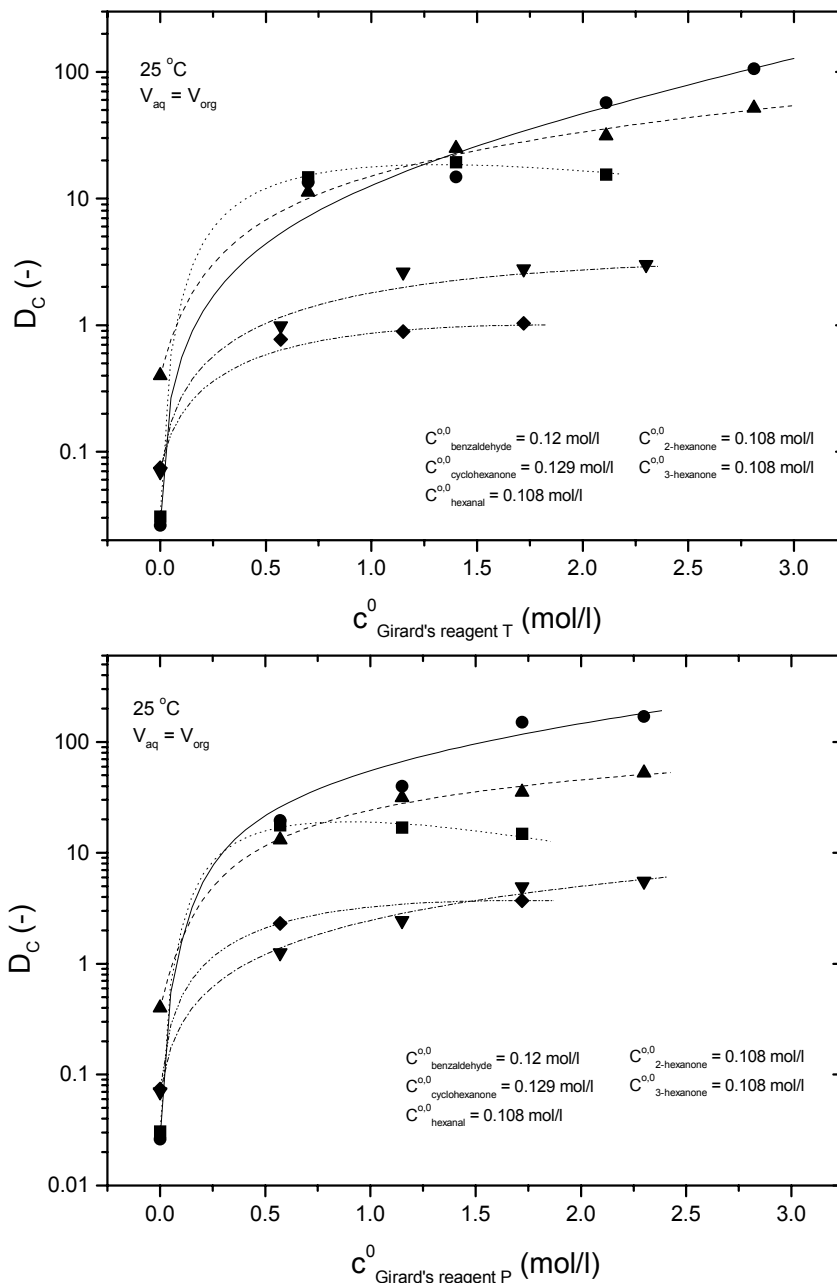
All amine salts, except sodium aminomethane sulfonate, show a salting-out capability toward benzaldehyde. However, this trend might not be the same if another carbonyl is extracted (as will be shown in the next paragraph).

### 3.5.3 Effect of type and structure of the carbonyl compound

The extraction performance of the same salt solutions was measured for various other carbonyl compounds (see Figures 3.5 - 3.7). The values of the reaction equilibrium constants and Setschenow parameters obtained by fitting the experimental results are given in Tab. 3.2.

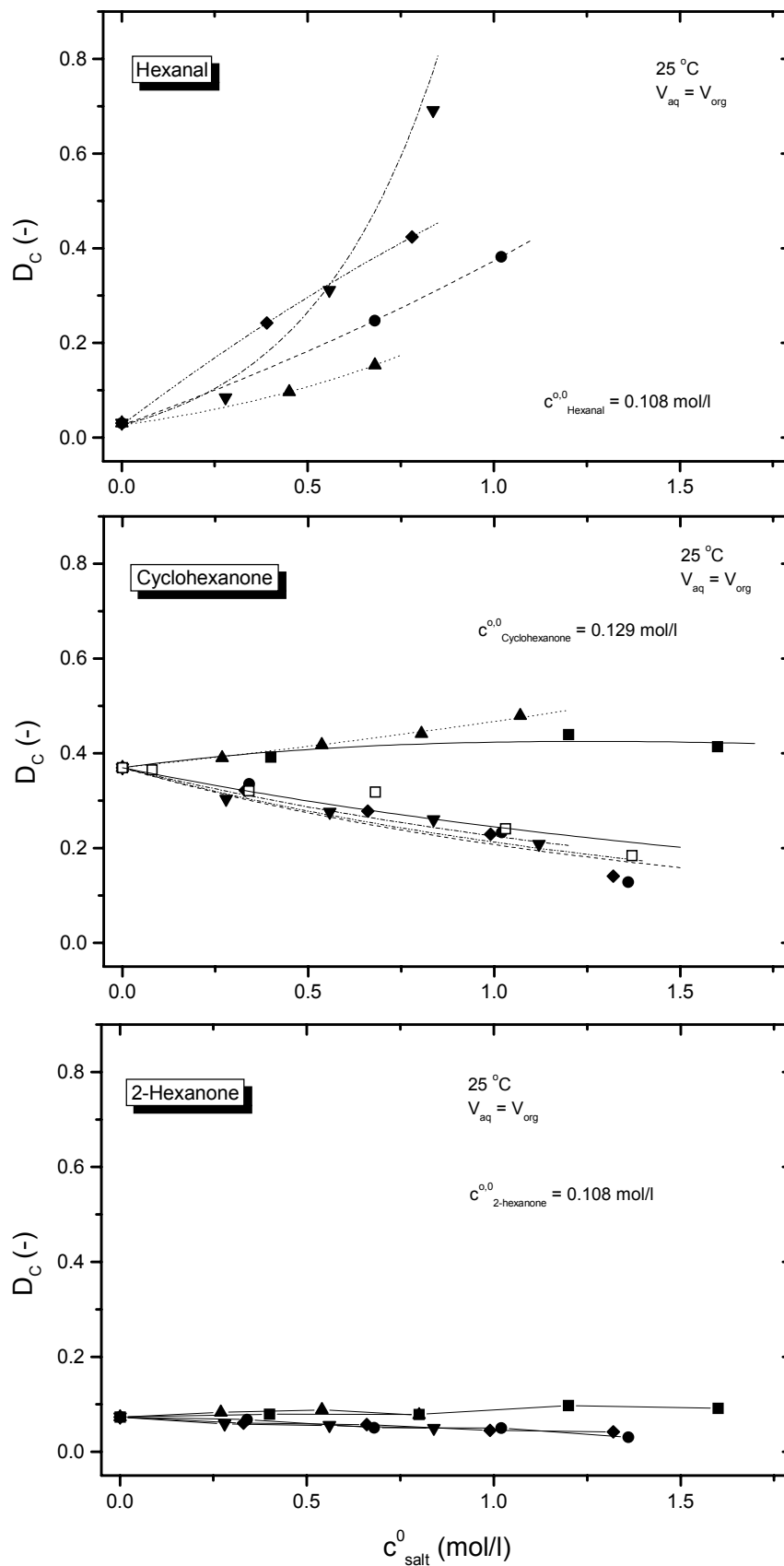


**Figure 3.5** Equilibrium distribution ratios of different carbonyls as a function of initial sodium hydrogen sulphite concentration in water: extraction of (●) benzaldehyde from toluene; (▲) cyclohexanone from cyclohexane; and (▼) 2-hexanone, (◆) 3-hexanone, or (■) hexanal from *n*-hexane.



**Figure 3.6** Equilibrium distribution ratios of different carbonyls as a function of the initial Girard's reagents concentration in water: extraction of (●) benzaldehyde from toluene; (▲) cyclohexanone from cyclohexane; and (▼) 2-hexanone, (◆) 3-hexanone, or (■) hexanal from n-hexane.

Obviously, the performance of the salt solutions varies greatly with the type of carbonyl to be extracted. For example, using sodium hydrogen sulphite solution, a distribution ratio of up to 300 was obtained for extraction of cyclohexanone, whereas for 3-hexanone, the value was not higher than 0.5. Although the chemical effects of this salt are similar for both aldehydes and cyclohexanone (see Table 3.2), still, the maximum distribution ratio is the highest for the extraction of cyclohexanone because of the higher solubility of cyclohexanone in pure water. Generally,  $K$  for the reactions with hydrogen sulphite decreases in the following order: hexanal > benzaldehyde > cyclohexanone > 2-hexanone > 3-hexanone, where the difference between cyclohexanone and 2-hexanone is large. Concerning the physical effects, all carbonyls are salted-out by sodium hydrogen sulphite, but the effect is most pronounced for hexanal.



**Figure 3.7** Equilibrium distribution ratios of different carbonyls as a function of the initial amine salt concentration in water: (●) sodium aminomethane sulfonate, (▲) sodium sulfanilate, (▼) sodium glycinate, (◆) sodium taurinate, (■) sodium p-amino benzoate, and (□) sodium 4-aminophenyl acetate.

Using solutions of hydrazine salts, the highest distribution ratio can be achieved for benzaldehyde (100-300), while the lowest distribution ratio is again for 3-hexanone (not higher than 3). The chemical effect decreases in the same order as for hydrogen sulphite, whereas the largest difference in this case is between aldehydes and ketones (at least 1 order of magnitude). Except for benzaldehyde, carbonyls were salted-out by the hydrazine salts, where the effect was strongest for hexanal.

As for benzaldehyde, the addition of amine salts improved the extraction capacity of pure water toward hexanal, but in the case of ketones, the capacity was reduced. The fact that these salts give a lower distribution ratio than is found in pure water leads to the conclusion that they do not react with the evaluated ketones, but only cause a physical interaction in the form of salting-out. The chemical effects ( $K$ ) on hexanal and benzaldehyde are generally similar in magnitude for all amines. Regardless, the amine salt solutions show a weaker extraction performance than the hydrogen sulphite or hydrazine salt solutions, giving equilibrium distribution ratios of less than 1.

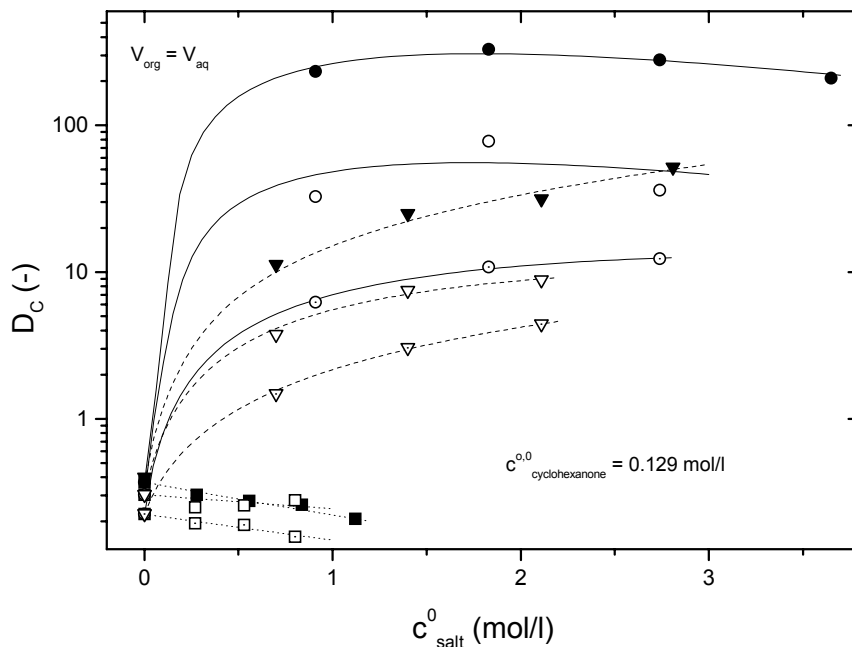
Although all three factors, inductive effects, resonance effects and steric effects of substituents attached to the carbonyl group, affect the stability of the carbonyl-extractant complex, it seems that the steric effect plays the most important role.<sup>14</sup> If the carbonyl group is more accessible, it is more susceptible to nucleophilic attack. Going from 3-hexanone, in which the carbonyl group is the most hindered, via cyclohexanone to hexanal, which has the most accessible carbonyl group, we see, in almost all cases, an increase in the  $K$  value. Therefore, we can conclude that aldehydes are more susceptible to nucleophilic attack than ketones (in some cases, ketones do not even react with nucleophiles at all, whereas aldehydes do), cyclic ketones than the straight-chain ones, and straight-chain aldehydes than aromatic.

However, the physical effect of a salt, as well as the physical distribution of the carbonyl between pure water and the organic solvent, must be considered together with the chemical effect when predicting the overall distribution ratio. The presence of both a salting-in effect and a high initial distribution ratio can result in much higher values of the overall distribution ratio than it would be expected if only the chemical effect were considered. This is the case, for example, for the extraction of cyclohexanone using sodium hydrogen sulphite solution. For comparison, the measured values of the physical distribution ratios of the evaluated carbonyls between pure water and the appropriate organic solvent are given explicitly in Table 3.3.

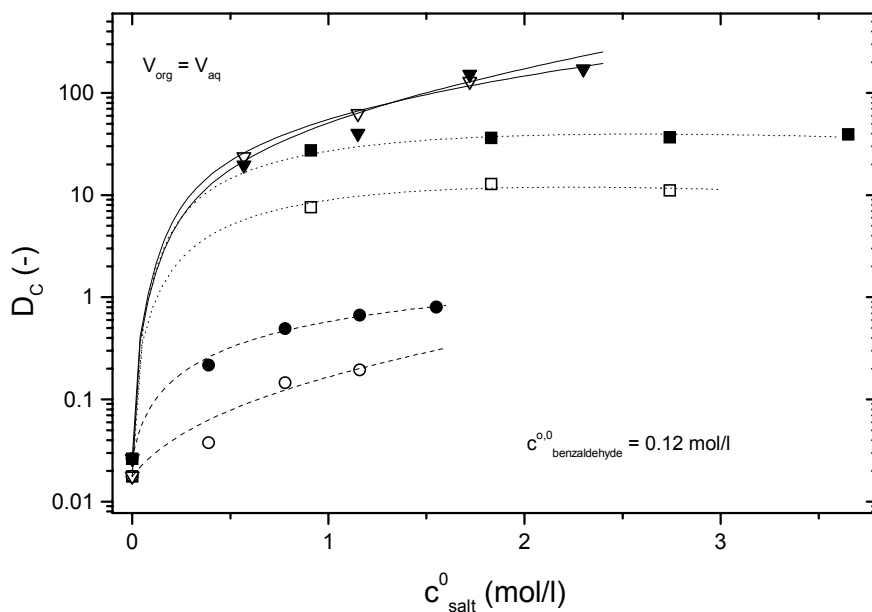
### 3.5.4 Back-extraction by temperature shift

After being extracted, the carbonyl compound needs to be recovered back from its nucleophilic addition product and separated from the aqueous phase. The separation from the aqueous phase can be done either by back-extraction in an apolar organic solvent followed by distillation (preferably using the same solvent from which the carbonyl is extracted to prevent contamination) or, if the volume of the carbonyl compound is not too low, by decantation of a newly formed, pure carbonyl phase. Furthermore, it is known that carbonyls can be recovered from their nucleophilic addition products by shifting the reaction equilibrium toward the reactants by a change of pH<sup>5,12,14</sup>, by microwave irradiation,<sup>19</sup> or by a change of temperature. The use of a temperature change for the recovery seems to be the simplest option, and hence it is the one chosen to be evaluated for the back-extraction of carbonyls from aqueous salt solutions. Therefore, the influence of temperature on the distribution ratio of benzaldehyde and cyclohexanone between an aqueous salt solution and the organic phase was measured. The results are shown in Figures 3.8 and 3.9, and Table 3.4

gives the values of the corresponding reaction equilibrium constants and Setschenow coefficients. Although the influence of temperature was measured for all evaluated salts, only the results for one representative of each type, one hydrazine, one hydrogen sulphite, and one amine solution, are shown. For the sake of comparison, the experimental results obtained at 25 °C are also given in the figures.



**Figure 3.8** Equilibrium distribution ratios of cyclohexanone as a function of temperature (solid points represent 25 °C, open 50 °C and crossed 70 °C) for solutions of (■, □, ⊞) sodium glycinate, (▼, ▽, ▿) Girard's reagent T, and (●, ○, ⊕) sodium hydrogen sulphite.



**Figure 3.9** Equilibrium distribution ratios of benzaldehyde as a function of temperature (solid points represent 25 °C and open ones 70 °C) for solutions of (●, ○) sodium taurinate, (▼, ▽) Girard's reagent P, and (■, □) sodium hydrogen sulphite.

**Table 3.3.** Physical distribution ratios of different carbonyls between pure water and the appropriate organic solvent  $[(K_D)'_c]$ .

| Carbonyl      | Organic solvent | T (°C) | $(K_D)'_c$ (-) <sup>a</sup> |
|---------------|-----------------|--------|-----------------------------|
| Benzaldehyde  | Toluene         | 25     | $2.6 \cdot 10^{-2}$         |
| Benzaldehyde  | Toluene         | 70     | $1.8 \cdot 10^{-2}$         |
| Cyclohexanone | Cyclohexane     | 25     | $3.7 \cdot 10^{-1}$         |
| Cyclohexanone | Cyclohexane     | 50     | $3.0 \cdot 10^{-1}$         |
| Cyclohexanone | Cyclohexane     | 70     | $2.2 \cdot 10^{-1}$         |
| Hexanal       | n-Hexane        | 25     | $3.1 \cdot 10^{-2}$         |
| 2-Hexanone    | n-Hexane        | 25     | $6.9 \cdot 10^{-2}$         |
| 3-Hexanone    | n-Hexane        | 25     | $7.4 \cdot 10^{-2}$         |

<sup>a</sup> Distribution ratios determined for the following initial concentrations of carbonyls in the organic solvent: benzaldehyde in toluene,  $c^0 = 0.12$  mol/l; cyclohexanone in cyclohexane,  $c^0 = 0.129$  mol/l; hexanal in n-hexane,  $c^0 = 0.108$  mol/l; 2-hexanone in n-hexane,  $c^0 = 0.108$  mol/l; 3-hexanone in n-hexane,  $c^0 = 0.108$  mol/l.

**Table 3.4.** Reaction equilibrium constants and Setschenow parameters at 50 and 70 °C.

| Salt                     | T (°C) | $K$ (l/mol)                | $k_S$ (l/mol)   |
|--------------------------|--------|----------------------------|-----------------|
| Cyclohexanone            |        |                            |                 |
| Sodium hydrogen sulphite | 50     | $(3 \pm 2) \cdot 10^2$     | $0.3 \pm 0.1$   |
|                          | 70     | $(4.5 \pm 0.3) \cdot 10^1$ | $0.1 \pm 0.1$   |
| Girard's reagent T       | 50     | $(3 \pm 2) \cdot 10^1$     | $0.1 \pm 0.2$   |
|                          | 70     | $9.4 \pm 0.7$              | $0.00 \pm 0.4$  |
| Sodium glycinate         | 50     | no reaction                | $0.10 \pm 0.03$ |
|                          | 70     | no reaction                | $0.18 \pm 0.04$ |
| Benzaldehyde             |        |                            |                 |
| Sodium hydrogen sulphite | 70     | $(9 \pm 3) \cdot 10^2$     | $0.20 \pm 0.07$ |
| Girard's reagent P       | 70     | $(2.0 \pm 0.2) \cdot 10^3$ | $-0.2 \pm 0.2$  |
| Sodium taurinate         | 70     | $5 \pm 4$                  | $-0.2 \pm 0.3$  |

As we can see from the results, the hydrogen sulphite solution has the greatest potential for use of a temperature shift for back-extraction. In this case, the distribution ratio decreases by a factor of 4 for benzaldehyde and by a factor of 20 for cyclohexanone for a 45 °C temperature increase. Amine solutions exhibited somewhat weaker effects from the temperature change than hydrogen sulphite, giving no more than a factor of 4 decrease in the distribution ratio in any case. In contrast, for hydrazine solutions, the temperature shift caused a much smaller change in distribution ratio for cyclohexanone and almost no change for benzaldehyde. This leads to the conclusion that a temperature shift might be a feasible option for the regeneration of chemically extracted carbonyls, but only if the reaction equilibrium constant  $K$  exhibits a sensitivity to temperature.

If we calculate the changes in enthalpy ( $\Delta H$ ) and entropy ( $\Delta S$ ) from the obtained experimental data, we can quantify and compare the sensitivity to temperature of the various equilibrium constants. For the reaction of cyclohexanone with sodium hydrogen sulphite  $\Delta H = -66$  kJ/mol, and  $\Delta S = -220$  J/mol·K, whereas for the reaction of cyclohexanone with

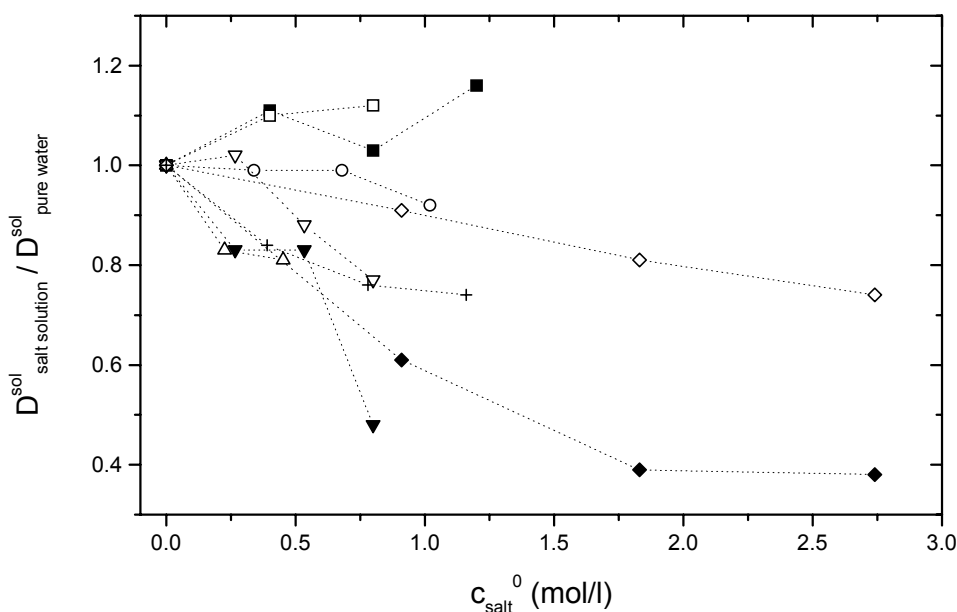
Girard's reagent T,  $\Delta H = -32$  kJ/mol, and  $\Delta S = -41$  J/mol·K. The reaction with hydrogen sulphite is more exothermic, but it also has much larger-magnitude  $\Delta S$ , creating stronger sensitivity to temperature. The negative value of  $\Delta S$  and its large magnitude for the case of hydrogen sulphite might be expected from the reaction mechanism (see Figure 3.1 and Scheme 3.1). In this reaction, two molecules produce one, causing a significant decrease of entropy.

Therefore, the values of  $\Delta H$  and  $\Delta S$  of a reaction that is considered for the reactive extraction of a carbonyl indicate whether a temperature shift can be used for regeneration of the carbonyl compound.

The temperature shift also has a certain effect on the distribution of the carbonyl in pure water (see Table 3.3). However, no significant effect on the salt's physical interaction with the carbonyl is noticed (see Tables 3.2 and 3.4). Variations occur in the value obtained for the Setschenow constant, but they can be attributed to experimental error rather than to a change in temperature.

### 3.5.5 Extraction selectivity

Thus far, the capacity of aqueous salt solutions to extract carbonyl compounds has been discussed. However, the selectivity of extraction solvents toward carbonyl compounds relative to that of the apolar organic solvent is also a key issue. Therefore, the equilibrium concentration of the organic solvent in the aqueous phase (which, divided by the solvent's molar density, provides the distribution ratio) relative to that obtained when pure water was the extraction solvent was measured. The results are shown in Figure 3.10.



**Figure 3.10** Normalised equilibrium distribution ratios of toluene (solid points) and cyclohexane (open points) as a function of the initial salt concentration at 25 °C for solutions of (○) sodium aminomethane sulfonate, (▼, ▽) sodium glycinate, (■, □) sodium p-amino benzoate, (◆, ◇) sodium hydrogen sulphite, (+) sodium taurinate, and (△) sodium sulfanilate.

As can be seen from the results, in all cases, except for sodium p-amino benzoate, the presence of the salt caused the organic solvent's distribution ratio to decrease. The salting-out was very weak in some cases, but in some cases, it was rather significant. Only sodium p-amino benzoate exhibited salting-in, but the effect was very slight. Therefore, salts improve



the selectivity toward carbonyls not only by enhancing the distribution ratio of a carbonyl, but also by reducing the distribution ratio of the organic solvent.

### 3.5.6 Effect of salts on water loss

To check for a possible enhancement of the solubility of water in the organic phase by the presence of a salt in the water, the concentration of water in the organic phase at equilibrium was also measured. The experimental results for the case of benzaldehyde extraction from toluene having aqueous salt solutions at their highest prepared concentrations are shown in Table 3.5.

**Table 3.5.** Concentration of water in the organic phase for extraction with different saturated aqueous solutions at 25 °C.

| Aqueous solution              | $c_{H_2O}^o$ (wt%) · 10 <sup>2</sup> |
|-------------------------------|--------------------------------------|
| Pure water                    | 6.0 ± 0.3                            |
| Sodium glycinate              | 5.4 ± 0.1                            |
| Girard's reagent P            | 5.1 ± 0.1                            |
| Girard's reagent T            | 4.8 ± 0.1                            |
| Sodium sulfanilate            | 5.4 ± 0.0                            |
| Sodium hydrogen sulphite      | 4.7 ± 0.1                            |
| Sodium p-amino benzoate       | 5.5 ± 0.1                            |
| Sodium taurinate              | 5.2 ± 0.1                            |
| Sodium amino methanesulfonate | 5.8 ± 0.3                            |

The results obtained indicate that the presence of a salt causes no enhancement in the solubility of water in the organic phase, but rather, a decrease of the water content, is noticed.

## 3.6 Conclusions

Aqueous salt solutions might have great potential for use as reactive extraction solvents in the recovery of carbonyl compounds present in few-percent concentrations in apolar organic solvents. The aqueous solutions of hydrogen sulphite or hydrazines show good extraction capacities by having distribution ratios of 3 for ketones with hindered carbonyl groups up to 300 for aldehydes. Generally, it is observed that the extractability decreases in the order linear aldehyde > aromatic aldehyde > cyclic ketone > linear ketone.

The immiscibility of the aqueous salt solutions with the apolar organic solvents is almost complete such that no significant loss of the extraction solvent into the raffinate occurs. Therefore, high selectivities toward the aldehyde or ketone relative to the apolar organic solvent are obtained.

Based on the observed behaviour of the distribution ratio with temperature, it seems that back-recovery of the chemically extracted carbonyl compound can generally be done by applying a simple temperature shift in combination with back-extraction or possibly even a simple decanting. If so, the aqueous salt solution can be directly recycled to the extraction unit after the phase separation, as no contaminants are introduced into the system and no need for salt recovery would be necessary. However, for some cases, as in the use of a hydrazine salt solution to extract benzaldehyde, options for back-recovery other than a

temperature shift have to be established because the latter did not show sufficient potential to be applied.

Regarding the specific solutions, amine salt solutions show much lower capacities toward carbonyls than either hydrogen sulphite or hydrazine solutions. Therefore, using an amine salt solution in an extraction process requires a higher solvent-to-feed ratio and/or more stages for the same extraction recovery. However, it might be the case that salts with low extraction capacities allow an easier back-recovery of the extracted product. Therefore, a recommendation suggesting that one aqueous salt solution is generally better as an extraction solvent than another one should be avoided. Instead, by considering all aspects of a specific process, an optimal solution should be found for each case.

Finally, a simple equilibrium model is found to be sufficient to describe the equilibria in the system. Both the Setschenow parameter and the physical distribution ratio for no-salt conditions are characterising the physical effect of the salt, whereas the reaction equilibrium constant describes the chemical effect of the salt on the carbonyl extraction.

## Literature Cited

- (1) Igawa, M.; Fukushi, Y.; Hayashita, T.; Hoffmann, M. R. Selective transport of aldehydes across an anion-exchange membrane via the formation of bisulfite adducts. *Ind. Eng. Chem. Res.* **1990**, *29*, 857-861.
- (2) Lieberman, S.; Prasad, V. V. K.; Warne, P. A. Polymeric reagents for the isolation and protection of carbonyl compounds. U.S. Patent 4.461.876, 1984.
- (3) Lores Arguin, M.; Vindevogel, J.; Sandra, P. Utilisation of the bisulfite addition reaction for the separation of neutral aldehydes by capillary electrophoresis. *Chromatographia* **1993**, *37*, 451-454.
- (4) Patai, S. *The Chemistry of the Carbonyl Group*; Interscience Publishers: New York, 1966; pp. 600-614.
- (5) Siggia, S.; Hanna, J. G. *Quantitative Organic Analysis via Functional Groups*; John Wiley And Sons: New York, 1979; pp. 95-160.
- (6) Wheeler, O. H. The Girard reagents. *J. Chem. Educ.* **1968**, *45*, 435.
- (7) Pitzer, K. S. Theory: Ion Interaction Approach. In *Activity Coefficients in Electrolyte Solutions*; Pytkowitz, R. M., Ed.; CRC Press: Florida, 1979; pp. 157-208.
- (8) Chen, C. C.; Britt, H. I.; Boston, J. F.; Evans, L. B. Local composition model for excess Gibbs energy of electrolyte solutions, Part 1: Single solvent, single completely dissociated electrolyte systems. *AIChE J.* **1982**, *28*(4), 588-596.
- (9) Chen, C. C.; Evans, L. B. A local composition model for the excess Gibbs energy of aqueous electrolyte systems. *AIChE J.* **1986**, *32*(3), 444-454.
- (10) Liu, Y.; Watanasiri, S. Successfully simulate electrolyte systems. *Chem. Eng. Prog.* **1999**, 25-41.
- (11) Long, F. A.; McDevit W. F. Activity coefficients of nonelectrolyte solutes in aqueous salt solutions. *Chem. Rev.* **1952**, *51*, 119-160.
- (12) Solomons, T. W. G. *Fundamentals of Organic Chemistry*, 4th ed.; John Wiley & Sons: New York, 1994.
- (13) Sergeeva, V. F. Salting-out and Salting-in of Non-Electrolytes. *Russ. Chem. Rev.* **1965**, *34*, 309-318.
- (14) Patai, S. *The Chemistry of the Carbon-Nitrogen Double Bond*; Interscience publishers: New York, 1970; pp. 468-485.
- (15) Kortum, G.; Vogel, W.; Andrussow, K. *Dissociation Constants of Organic Acids in Aqueous Solution*; Butterworths: London, 1961.
- (16) ZirChrom Separations Inc. <http://www.zirchrom.com/organic.htm> (accessed Feb 2002).
- (17) Perrin, D. D. *Dissociation Constants of Organic Bases in Aqueous Solution*; Butterworths: London, 1965; pp. 364.
- (18) Jacobs, A. *Understanding Organic Reaction Mechanisms*; Cambridge University Press: Cambridge, 1997.
- (19) Boruah, A.; Baruah, B.; Prajapati, D.; Sandhu, J. S. Regeneration of Carbonyl Compounds from Oximes under Microwave Irradiations. *Tetrahedron Lett.* **1997**, *38*, 4267-4268.



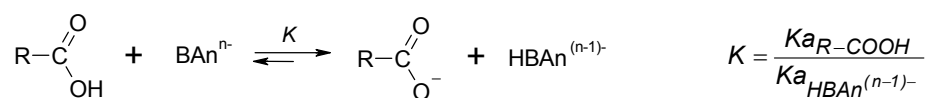
## Chapter 4

# Reactive extraction of carboxylic acids

### 4.1 Introduction

It is well known that low-water soluble carboxylic acids, but also other compounds having sufficient acidic properties, can be efficiently extracted from an organic into an aqueous phase by means of dissociation extraction. The use of an aqueous solution of sodium or calcium hydroxide to extract acids, phenols or mercaptans from hydrocarbon solvents is very common in industrial practice.<sup>1,2</sup> Furthermore, recovery of many other compounds by dissociation extraction, using the same or other extractants, has been evaluated by different authors.<sup>3,4,5,6,7</sup> It should be emphasised that the extraction is applied on the recovery from dilute organic solutions, since that is the area where extraction is advantageous over distillation.

In all cases, a basic compound dissolved in water causes enhanced dissociation of a carboxylic acid generating a carboxylate ion that is much more soluble in water than the protonated acid. The dissociation reaction is shown in Scheme 4.1.

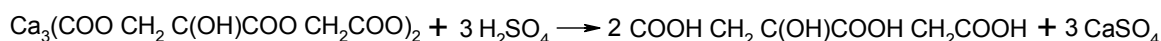


**Scheme 4.1** Dissociation of carboxylic acid (R-COOH) into carboxylate (R-COO<sup>-</sup>) caused by a basic anion (BAn<sup>n-</sup>) in which a protonated anion (HBA<sup>(n-1)-</sup>) is generated.

In that way, the acid is extracted from an apolar organic solvent into the aqueous phase as carboxylate. The essential selection criterion for a suitable extractant is that its dissociation constant ( $K_{a_{\text{HBA}^{(n-1)-}}}$ ) is lower than the one of the carboxylic acid ( $K_{a_{\text{R-COOH}}}$ ), i.e. the protonated extractant should be weaker acid than the carboxylic acid. However, besides that, it is also desirable that the extractant is highly soluble in water, has acceptable toxic and environment impact characteristics, but also to be as cheap as possible.

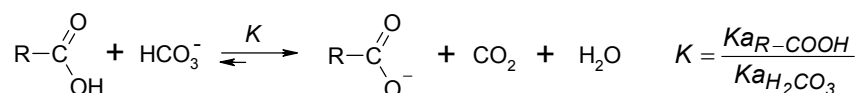
After extraction has been completed, and the organic and aqueous phases separated, the carboxylate needs to be converted back into the acid and recovered from the aqueous solution. Commonly, this is done by introducing a strong mineral acid in the extract and performing back-extraction into an apolar organic solvent from which the acid is

subsequently distilled. As a large-scale example of such recovery, the fermentative production of lactic and citric acids can be mentioned. Here, sulphuric acid is used to regenerate the acid which is back-extracted into an organic solvent.<sup>8</sup> Although feasible, a major disadvantage of such recovery processes is generation of a salt which needs to be removed from water to allow recycle of the aqueous solution in the extraction section. In the mentioned recovery of the extracted citric acid by sulphuric acid, gypsum precipitate is formed as shown in Scheme 4.2.

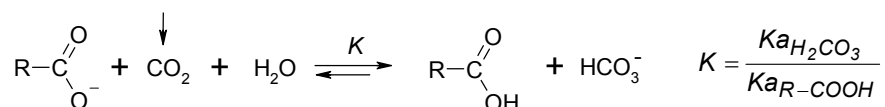


**Scheme 4.2** Conventional regeneration of extracted citric acid with gypsum generation.<sup>8</sup>

In this chapter, a potential solution to eliminate this disadvantage is proposed and experimentally evaluated. It assumes the use of an aqueous solution of hydrogen carbonate ( $\text{HCO}_3^-$ ) for the extraction, followed by back-recovery of the extracted acid using carbon dioxide ( $\text{CO}_2$ ). In the extraction step, the hydrogen carbonate salt causes dissociation of the acid where carbon dioxide and water are formed (see Scheme 4.3), whereas in the back-recovery, carbon dioxide under pressure shifts the carboxylic acid equilibrium toward the undissociated form generating only  $\text{HCO}_3^-$  (see Scheme 4.4). In this way no new salts are formed, but only  $\text{CO}_2$  in the extraction and  $\text{HCO}_3^-$  in the back-recovery step, which can be recycled to the next recovery or extraction cycle, respectively.



**Scheme 4.3** Dissociation of carboxylic acid ( $\text{R-COOH}$ ) into carboxylate ( $\text{R-COO}^-$ ) by a hydrogen carbonate salt.

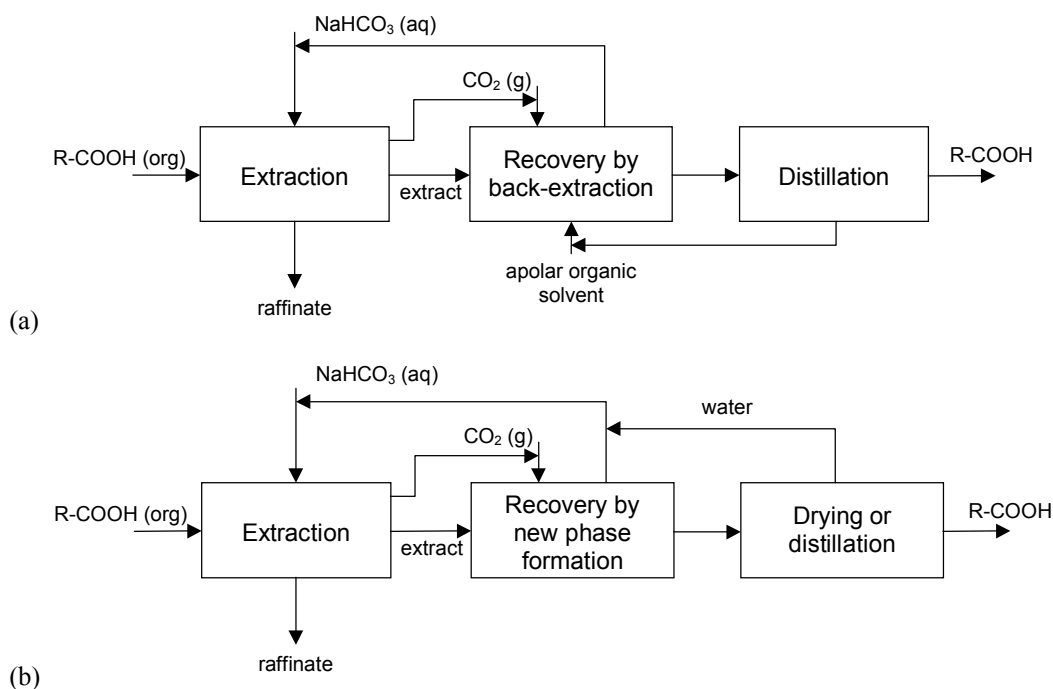


**Scheme 4.4** Proposed regeneration of extracted carboxylic acid aided by carbon dioxide under pressure.

The regenerated acid can be back-extracted, as done in conventional processes, or separated from the aqueous solution as a newly formed liquid or solid phase. The back-extraction option assumes use of an apolar organic solvent in which the regenerated acid is extracted under pressure and it requires a distillation step in which the solvent is removed. In case of back-recovery by a new phase formation, the formed liquid or solids need to be separated from the aqueous solution while the system is still under pressure. Once that is done, and if a dry product is required, water should be removed by distillation from the liquid product or by drying from the solids (see Figure 4.1).

In order to explore the feasibility of the above-described options, the equilibrium distribution ratio of three different low water-soluble carboxylic acids - benzoic, hexanoic and decanoic acid - between an aqueous sodium hydrogen carbonate solution and an appropriate apolar organic solvent has been measured. This should give an insight in the extraction capacity of this salt solution toward both aromatic and aliphatic acids. The distribution ratio is evaluated for an initial mass fraction of acid of 1.5 wt% in either toluene (for benzoic acid), n-hexane (for hexanoic acid) or n-decane (for decanoic acid). That initial mass fraction represents cases of low concentration of an acid in the solvent (it is equal to the concentration of benzoic acid in toluene after the liquid-phase oxidation, as discussed in Chapter 1).

Furthermore, the recovery of two carboxylate salts - sodium benzoate and sodium hexanoate - from the aqueous phase, using carbon dioxide under pressure, by both back-extraction in an apolar organic solvent or by formation of a new phase, is evaluated. The first salt generates a new solid and the second one a new liquid phase during the recovery. The influence of pressure and temperature (the operating region in which the recovery is considered is shown in Figure 4.2), initial mass fraction of carboxylate in the aqueous solution, type of the organic solvent and the initial solvent-to-feed ratio is analysed. Furthermore, the effect of adding a salting-out agent in water is examined, because it is suggested that this could improve the recovery by salting-out the regenerated acid from water.



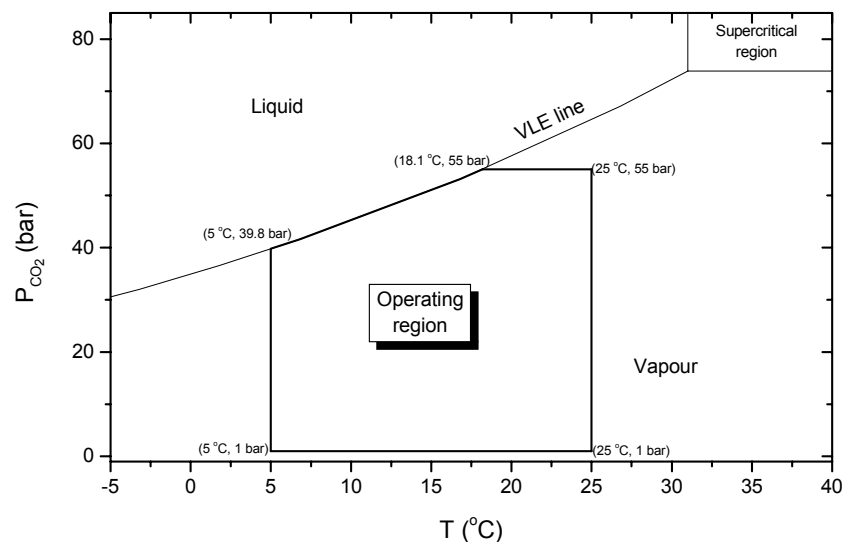
**Figure 4.1** Scheme of separation of a carboxylic acid from an apolar organic solvent by reactive extraction using an aqueous sodium hydrogen carbonate solution and with back-recovery of extracted acid by (a) back-extraction or (b) new phase formation.

The initial mass fraction of the carboxylate is varied from 6 to 15 wt%, which is around 4 to 12 times more than the one originally present in the apolar organic solvent. It is found feasible that a 4 to 12 times mass fraction increase is achieved in the extraction step. The solvents considered for the back-recovery by back-extraction of benzoic acid are toluene, benzaldehyde, benzyl alcohol and liquid carbon dioxide, whereas n-hexane and liquid carbon dioxide are investigated for hexanoic acid. Toluene and n-hexane are the obvious choices since these are the solvents in which the acids are originally present in their production process. Benzaldehyde and benzyl alcohol may be considered since they are, like benzoic acid, also products of the toluene oxidation (see Chapter 1) and therefore their use would not cause any contamination of the system. Liquid carbon dioxide, if applicable, could be an attractive option for the back-recovery by back-extraction since its use could eliminate a subsequent distillation step. Simple reduction of the pressure after back-extraction would be sufficient to remove the solvent and obtain the pure acid.

Sodium chloride and sodium nitrate, as the salts known to strongly reduce the solubility of carboxylic acids in water,<sup>9,10</sup> are considered as salting-out agents. They decrease the solubility of carbon dioxide as well. However, if that effect is weaker than the one on the

acid, the recovery would be enhanced. Their effect is experimentally evaluated on the case of the back-recovery of benzoic acid by precipitation.

Simple models describing the physical and chemical equilibria in both, forward-extraction and back-recovery, steps are established and their validity is evaluated on the experimental results.



**Figure 4.2** The pressure-temperature region in which the carbon dioxide aided back-recovery is evaluated.

## 4.2 Use of gasses under pressure for recovery purposes

There are many examples where a gas is used for recovery purposes. Some of them can be found in the field of extraction, some in adsorption and some in precipitative recovery. The Carix process<sup>11</sup> is applied for the regeneration of resin beds in a drinking water treatment or elution of amino acids from an anion exchange column in separation of amino acids. In that case, carbon dioxide at 5 bar is dissolved in water and that solvent is used for the regeneration/ellution.<sup>12</sup> Carbon dioxide up to 60 bar, in the temperature range 5 to 50 °C, is applied for the isoelectric precipitation of protein casein from milk.<sup>13</sup>

Extractive processes, especially those applying amine containing reactive solvents, are numerous. Water-soluble amines in combination with carbon dioxide under pressure are used for reactive extraction of carboxylic acids from aqueous calcium carboxylate solutions.<sup>14</sup> Extraction of lactic acid from aqueous lactate solutions into amine containing organic solvents, for example Alamine 336 in chloroform, Amberlite LA-2 in 1-octanol or tridodecyl amine in isopropanol, by contacting the system with carbon dioxide are also reported.<sup>15,16</sup> Furthermore, back extraction of propylene glycol from a reactive organic solvent (Aliquat 336 and phenylborate in 2-ethylhexanol, toluene, o-xylene or diisopropyl ketone) in water, by means of pressurised carbon dioxide, has been another reported example.<sup>17</sup>

All these examples exploit the acidic or basic properties of a gas. However, the use of gasses under the pressure but not as a pH modifiers, is also known. Ethylene or methane under pressure is introduced micelar solutions of encapsulated proteins to modify physiochemical characteristics of the solution and cause protein desolubilization.<sup>18</sup> Carbon dioxide is used for gas anti-solvent recrystallization of cyclotrimethylenetriamine, an explosive substance, from acetone or cyclohexane.<sup>19</sup>



The release of acidic organic compounds from their salts dissolved in water by carbon dioxide, as reported in the patent literature,<sup>20</sup> is the closest to the carbon dioxide aided recovery by back-extraction, treated in this work. This process is described for the release of 6-hydroxy-2-naphthalenecarboxylic acid from its dipotassium salt, 3-hydroxy-2-naphthalenecarboxylic acid from its disodium salt, 1-naphthalenecarboxylic acid from its potassium salt, benzoic acid from its potassium salt, etc. In all cases, an aqueous solution of a carboxylate salt is contacted with carbon dioxide in presence of 1-butanol as extraction solvent. For the release of benzoic acid, a solvent-to-feed ratio of 1 and 5 bar pressure is applied. Recoveries up to 29% from 5 wt% potassium benzoate solution are reported.

### 4.3 Equilibrium models

There are many detailed thermodynamic models based on activity coefficients or equation of state that could be used to describe all physical and reaction equilibria in the evaluated systems. However, the scope of this work is the exploration of the applicability of an aqueous solution of sodium hydrogen carbonate as reactive extraction solvent and the use of carbon dioxide under pressure for back-recovery rather than detailed thermodynamic modelling. Therefore, description of the existing equilibria is done using as simple models as possible. Furthermore, the parameters that are used in such models are obtained from the literature (see Appendix A1). Several, which could not be found, are derived from the available experimental data. Those are the physical distribution ratio of decanoic acid, which is determined in the equilibrium experiments between pure water and n-decane, and the physical distribution ratio of hexanoic acid, which is determined in the equilibrium experiments between pure water and n-hexane. The solubility equilibrium constants of benzoic acid in benzaldehyde and benzyl alcohol, used in the back-recovery model (Section 4.3.1) are determined by fitting the experimental results (given in Section 4.5). Therefore, except for the back-recovery of benzoic acid by back-extraction into benzaldehyde and benzyl alcohol, all model results presented in Section 4.5 are predicted values.

The model which describes the extraction of the acid is simpler and requires less equations than the back-extraction model. Except for a difference in mole balance, all equations of the extraction model are also part of the back-extraction model. Therefore, the latter is discussed first involving all present equilibrium phenomena. For the extraction model it is indicated which of these equations are used.

#### 4.3.1 Carbon dioxide aided back-recovery

The evaluated options for the back-recovery of the extracted acid from the aqueous phase require a model capable of describing several cases. These cases are listed in Table 4.1. The existence of the given phases (vapour, liquid or solid) is based on the fact that the recovery is done in the temperature range 5 - 30 °C.

The cases A and B represent the recovery of benzoic acid by precipitation and of hexanoic acid by a new liquid phase formation, respectively. Case C describes the recovery of benzoic acid by precipitation using a salting-out agent with sodium as its cation. The recovery of benzoic or hexanoic acid by back-extraction is described by case D, whereas case E represents the recovery of benzoic acid by back-extraction if the capacity of the back-extraction solvent is exceeded, and a new solid phase is formed.

Figure 4.3 shows the equilibria of the case E. For the other cases, the scheme would have less phases and maybe less species, but the same chemical equilibria will be present.

**Table 4.1** Equilibrium cases that need to be described for back-recovery.

| Case | Number of phases | Type of phase equilibrium <sup>a</sup> | Number of equilibrium reactions | Number of species     |
|------|------------------|--|---------------------------------|-----------------------|
| A    | 3                | VLS                                    | 4                               | 9 <sup>b</sup>        |
| B    | 3                | VLL                                    | 4                               | 9 <sup>b</sup>        |
| C    | 3                | VLS                                    | 4                               | 10 <sup>c</sup>       |
| D    | 3                | VLL                                    | 4                               | 10 <sup>d</sup>       |
| E    | 4                | VLLS                                   | 4                               | 10 (9) <sup>d,e</sup> |

<sup>a</sup> V - vapour, L - liquid, S - solid.

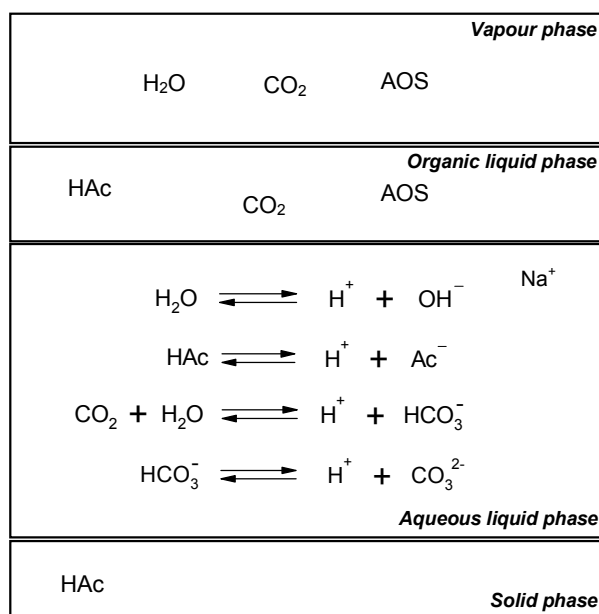
<sup>b</sup> Water (H<sub>2</sub>O), carbon dioxide (CO<sub>2</sub>), carboxylic acid (HAc), hydrogen ion (H<sup>+</sup>), hydroxide ion (OH<sup>-</sup>), sodium ion (Na<sup>+</sup>), hydrogen carbonate ion (HCO<sub>3</sub><sup>-</sup>), carbonate ion (CO<sub>3</sub><sup>2-</sup>) and carboxylate ion (Ac<sup>-</sup>).

<sup>c</sup> Same as for option E, but with the anion of the salting-out agent (Cl<sup>-</sup> or NO<sub>3</sub><sup>-</sup>).

<sup>d</sup> Same as for option E, but with apolar organic solvent.

<sup>e</sup> Nine species instead of 10 are present if the used apolar organic solvent is liquid carbon dioxide.

Therefore, the description of the vapour-liquid, liquid-liquid and solid-liquid phase equilibria, as well as the reaction equilibria, and the influence of electrolytes on those, have to be incorporated in the model. However, for each of the above-described equilibrium cases, the set of the equations necessary to describe the system is somewhat different, depending on the number of phases and the number and type of species involved. All necessary equations are first introduced and latter (Section 4.3.1.5) is stated which set of equations is used for which case.



**Figure 4.3** Scheme of the four-phase equilibrium involving 10 species and 4 chemical equilibrium reactions in the back-recovery of benzoic acid by back-extraction if the capacity of the back-extraction solvent is exceeded (see Table 4.1 for full names of the species).

To simplify the model, the following assumptions are adopted:

- water is not present in the organic liquid phase and the apolar organic solvent does not dissolve in the aqueous phase, i.e. they are considered immiscible (when benzyl alcohol is used as the solvent this assumption is not made due to its non-negligible miscibility with water),

- charged species (ions) are present only in the aqueous phase,
- the solid phase, if present, consists of carboxylic acid only, i.e. there is no precipitation of other species,
- the solubility of water and carbon dioxide in the hexanoic acid liquid phase is neglected (in the back-recovery of hexanoic acid by new liquid phase formation),
- the vapour phase contains the pressurised carbon dioxide, water and, if present in the system, apolar organic solvent.

#### 4.3.1.1 Phase equilibria

**Vapour-liquid equilibria.** The vapour-liquid equilibria of carbon dioxide are described by Henry's law:

$$x_{\text{CO}_2}^a \cdot He_{\text{CO}_2}^{\text{H}_2\text{O}} = P \cdot y_{\text{CO}_2} \quad (4-1)$$

$$x_{\text{CO}_2}^o \cdot He_{\text{CO}_2}^{\text{AOS}} = P \cdot y_{\text{CO}_2} \quad (4-2)$$

while for the apolar organic solvent and water, Raoult's law is used:

$$x_{\text{H}_2\text{O}}^a \cdot P_{\text{H}_2\text{O}}^{\text{sat}} = P \cdot y_{\text{H}_2\text{O}} \quad (4-3)$$

$$x_{\text{AOS}}^o \cdot P_{\text{AOS}}^{\text{sat}} = P \cdot y_{\text{AOS}} \quad (4-4)$$

In those equations  $x_i$  is the mole fraction of either water, organic solvent or carbon dioxide in the aqueous (superscript *a*) or organic phase (superscript *o*), whereas  $y_i$  represents the vapour phase mole fraction.  $He_{\text{CO}_2}$  is Henry's coefficient of carbon dioxide for pure water or for the pure apolar organic solvent,  $P$  is the absolute pressure and  $P^{\text{sat}}$  is the saturated vapour pressure. Henry's coefficients and vapour pressures are taken as for pure water or pure organic solvent.

The influence of NaCl or NaNO<sub>3</sub> on the equilibrium mole fraction of carbon dioxide in the aqueous phase is modelled using Setschenow equation. In its original form, this equation correlates the solubility of a solute in water ( $S$ ) as a function of the salt concentration ( $c_S$ ), both expressed in mol per liter solvent.<sup>21</sup>

$$\log \frac{S_0}{S} = \log(\gamma) = k_S \cdot c_S \quad (4-5)$$

where  $S_0$  is the solute's solubility in pure water and  $k_S$  is the Setschenow constant.

If expressed in mole fractions on salt-free basis using equation (4-5), the mole fraction of carbon dioxide in the aqueous solution of NaCl or NaNO<sub>3</sub> ( $x_{\text{CO}_2}^a$ ) can be calculated from:

$$\log \left( \frac{x_{\text{CO}_2,0}^a / x_{\text{H}_2\text{O},0}^a}{x_{\text{CO}_2}^a / x_{\text{H}_2\text{O}}^a} \right) = k_{S,\text{CO}_2} \cdot c_S \quad (4-6)$$

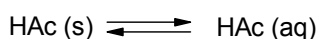
where  $x_{\text{H}_2\text{O}}^a$  is the mole fraction of water in that case, whereas  $x_{\text{CO}_2,0}^a$  and  $x_{\text{H}_2\text{O},0}^a$  are the values determined for salt-free conditions.

The values of the Setschenow constant as reported in the literature (or solubility data from which they can be derived) are usually given in l/mol. Therefore, by expressing the salt quantity as concentration ( $c_S$ ), a direct application of the literature values of Setschenow

constants is allowed. Also, involving the salt quantity as a concentration, instead of mole fraction, allows an easier balancing on salt-free basis (no consumption or generation of the salt is assumed).

The influence of the salting-out agents on the saturation vapour pressure of water is not incorporated, i.e. mole fraction of water in the vapour phase is calculated from equation (4-3). This is done since the vapour phase composition is not the issue of concern. However, if it would be, than this effect must also be described.

**Solid-liquid equilibria.** The equilibrium between solid and dissolved carboxylic acid,



is expressed using solubility equilibrium constants:

$$K_{\text{HAc}}^{\text{H}_2\text{O}} = \frac{x_{\text{HAc}}^{\text{a}}}{x_{\text{H}_2\text{O}}^{\text{a}}} \quad (4-7)$$

$$K_{\text{HAc}}^{\text{AOS}} = \frac{x_{\text{HAc}}^{\text{o}}}{x_{\text{AOS}}^{\text{o}}} \quad (4-8)$$

where  $K_{\text{HAc}}^{\text{H}_2\text{O}}$  represents the equilibrium between the solid and the acid dissolved in pure water and  $K_{\text{HAc}}^{\text{AOS}}$  between the solid and the acid dissolved in pure apolar organic solvent.

Again, it is assumed that the other solutes present in the aqueous or organic phase do not influence the acid solubility and therefore that the solubility equilibrium constants for pure water and for pure organic solvent can be directly applied. However, if NaCl or NaNO<sub>3</sub> are present in the system, the Setschenow equation (4-5) has to be used to describe the influence of the salts on the solubility of the acid in the aqueous phase ( $x_{\text{HAc}}^{\text{a}}$ ):

$$\log \left( \frac{x_{\text{HAc},0}^{\text{a}}/x_{\text{H}_2\text{O},0}^{\text{a}}}{x_{\text{HAc}}^{\text{a}}/x_{\text{H}_2\text{O}}^{\text{a}}} \right) = k_{\text{S,HAc}} \cdot c_{\text{S}} \quad (4-9)$$

where  $k_{\text{S,HAc}}$  is the Setschenow constant for the carboxylic acid, and the mole fractions  $x_{\text{HAc},0}^{\text{a}}$  and  $x_{\text{H}_2\text{O},0}^{\text{a}}$  are the values for salt-free conditions.

**Liquid-liquid equilibria.** The physical distribution ratio of the carboxylic acid between the organic and the aqueous phase,  $(K_{\text{D}})_{\text{HAc}}$ , is defined as:

$$(K_{\text{D}})_{\text{HAc}} = \frac{x_{\text{HAc}}^{\text{o}}}{x_{\text{HAc}}^{\text{a}}} = \frac{K_{\text{HAc}}^{\text{AOS}}}{K_{\text{HAc}}^{\text{H}_2\text{O}}} \cdot \frac{x_{\text{AOS}}^{\text{o}}}{x_{\text{H}_2\text{O}}^{\text{a}}} \quad (4-10)$$

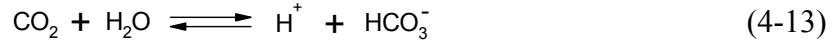
The distribution of carbon dioxide, which is also present in both liquid phases, has been already implicitly described by equations (4-1) and (4-2).

In case of the recovery of hexanoic acid by new phase formation, the equilibrium between pure liquid hexanoic acid and the dissolved acid is also described by equation (4-7).

#### 4.3.1.2 Reaction equilibria

The following four reactions occur in the aqueous phase:





Each of the above reactions is characterised by a reaction equilibrium constant ( $K_i$ ). For example, for the water dissociation (4-11) on molal scale is:<sup>22</sup>

$$K_{\text{H}_2\text{O}} = \frac{a_{\text{H}^+} \cdot a_{\text{OH}^-}}{a_{\text{H}_2\text{O}}} = \frac{\gamma_{\text{H}^+} \left( \frac{m_{\text{H}^+}^a}{m^0} \right) \cdot \gamma_{\text{OH}^-} \left( \frac{m_{\text{OH}^-}^a}{m^0} \right)}{a_{\text{H}_2\text{O}}} \quad (4-11a)$$

where term  $\gamma_i \cdot (m_i/m^0)$  represents the activity of specie  $i$  ( $a_i$ ),  $m_i^a$  its molality in the aqueous phase in mol/kg,  $\gamma_i$  the activity coefficient and  $m^0$  the standard molality of 1 mol/kg.

Since all previous equations use mole fractions, it is convenient to express also equation (4-11a) in mole fractions (conversion of molality to mole fraction is done using the expression  $x_i^a = (m_i^a / m_{\text{H}_2\text{O}}^a) \cdot x_{\text{H}_2\text{O}}^a$ ):

$$K_{\text{H}_2\text{O}} = \frac{x_{\text{H}^+}^a \cdot x_{\text{OH}^-}^a}{(x_{\text{H}_2\text{O}}^a)^3} \cdot \frac{m_{\text{H}_2\text{O}}^a}{(m^0)^2} \cdot \frac{\gamma_{\text{H}^+} \cdot \gamma_{\text{OH}^-}}{1} \quad (4-11b)$$

where  $m_{\text{H}_2\text{O}}^a$  is molality of water in the aqueous phase and is equal to 55.6 mol/kg.

Analogously, for the remaining reactions:

$$K_{\text{HAc}} = \frac{x_{\text{H}^+}^a \cdot x_{\text{Ac}^-}^a}{x_{\text{HAc}}^a \cdot x_{\text{H}_2\text{O}}^a} \cdot \frac{m_{\text{H}_2\text{O}}^a}{m^0} \cdot \frac{\gamma_{\text{H}^+} \cdot \gamma_{\text{Ac}^-}}{\gamma_{\text{HAc}}} \quad (4-12a)$$

$$K_{\text{CO}_2} = \frac{x_{\text{H}^+}^a \cdot x_{\text{HCO}_3^-}^a}{x_{\text{CO}_2}^a \cdot (x_{\text{H}_2\text{O}}^a)^2} \cdot \frac{m_{\text{H}_2\text{O}}^a}{m^0} \cdot \frac{\gamma_{\text{H}^+} \cdot \gamma_{\text{HCO}_3^-}}{\gamma_{\text{CO}_2}} \quad (4-13a)$$

$$K_{\text{HCO}_3^-} = \frac{x_{\text{H}^+}^a \cdot x_{\text{CO}_3^{2-}}^a}{x_{\text{HCO}_3^-}^a \cdot x_{\text{H}_2\text{O}}^a} \cdot \frac{m_{\text{H}_2\text{O}}^a}{m^0} \cdot \frac{\gamma_{\text{H}^+} \cdot \gamma_{\text{CO}_3^{2-}}}{\gamma_{\text{HCO}_3^-}} \quad (4-14a)$$

The reason for the involvement of the activity coefficients in equations (4-11b) - (4-14a) is the necessity to describe the reaction equilibria in case when NaCl or NaNO<sub>3</sub> is present. Therefore, for all back-recovery cases, except for the case when NaCl or NaNO<sub>3</sub> is used, the term that groups activity coefficients in those equations is assumed to be equal to one.

If NaCl or NaNO<sub>3</sub> is present, than the activity coefficients of the neutral species (carbon dioxide and unprotonated acid) are calculated again using the Setschenow equation (4-5):

$$\log(\gamma_i) = k_{S,i} \cdot c_S \quad (4-15)$$

whereas Pitzer's extension of the Debye-Hückel law, derived from the equation for the excess energy of an electrolyte aqueous solution,<sup>23,24,25</sup> is used to determine the activity coefficients of charged species (carboxylate, hydrogen carbonate, carbonate and hydrogen ions):

$$\ln \gamma_i = -A_\phi \cdot z_i^2 \left[ \frac{2}{b} \ln(1 + b\sqrt{I}) + \frac{\sqrt{I}}{1 + b\sqrt{I}} \right] + 2 \sum_{j \neq H_2O} m_j \left[ \beta_{ij}^{(0)} + \beta_{ij}^{(1)} \cdot \frac{2}{\alpha^2 I} \left[ 1 - (1 + \alpha\sqrt{I}) \cdot e^{-\alpha\sqrt{I}} \right] \right] \quad (4-16)$$

In equation (4-16),  $A_\phi$  is the Debye-Hückel parameter for the osmotic coefficient.<sup>25</sup>

$$A_\phi = \frac{1}{3} \left( 2\pi N_A \frac{\rho_{H_2O}}{1000} \right)^{0.5} \left( \frac{e^2}{4\pi\epsilon_0 D k T} \right)^{1.5} \quad (4-17)$$

and  $I$  is the ionic strength (kg/mol):

$$I = \frac{1}{2} \sum_i m_i z_i^2 \quad (4-18)$$

$z_i$  is the charge of specie  $i$  and  $\alpha$  and  $b$  are Pitzer's parameters which are 2.0 (kg/mol)<sup>0.5</sup> and 1.2 (kg/mol)<sup>0.5</sup>, respectively.<sup>23</sup>  $\beta_{ij}^{(0)}$  and  $\beta_{ij}^{(1)}$  are binary interaction parameters expressed in kg/mol. Furthermore,  $N_A$  is Avogadro's number,  $\rho_{H_2O}$  is the density of pure water,  $e$  is the elementary charge,  $k$  is the Boltzmann's constant,  $D$  is the dielectric constant and  $\epsilon_0$  is the permittivity of free space.

Although simpler equations treating activity coefficients of charged species exist (Debye-Hückel limiting law, Debye-Hückel extension, Davies equation, etc.) Pitzer's model is the simplest one which can be applied for high salt concentrations (up to 6 mol/kg).<sup>23,24</sup> It is therefore suitable for the systems considered in this work in which salt molality is in the range 1 - 5 mol/kg. However, the complete Pitzer's equation for activity coefficients contains two additional terms on the right side relative to that presented in equation (4-16).<sup>25</sup> The first describes the binary interactions between each specie in the system with another one, while the last one considers the ternary interactions. Since these two terms are seen not to contribute significantly to the final value of activity coefficient, in the cases treated in this work, and in order to keep the model as simple as possible (as less parameters as possible), these terms are neglected. A similar approach can be seen elsewhere in the literature.<sup>26</sup>

In addition, binary interactions of two charged species of the same sign (for example,  $Na^+$  with  $H^+$  or  $Cl^-$  with  $HCO_3^-$ ) and interactions of two charged species forming a weak electrolyte (for example,  $H^+$  with  $HCO_3^-$  or  $H^+$  with  $OH^-$ ) are neglected, as recommended in the literature.<sup>25</sup> Therefore, binary interactions of interest for our system are:  $Na^+$  with  $HCO_3^-$ ,  $Na^+$  with  $CO_3^{2-}$  and  $Na^+$  with  $Ac^-$ ,  $H^+$  with  $Cl^-$  and  $H^+$  with  $NO_3^-$ . Although a strong electrolyte is formed also in interaction of  $Na^+$  with  $Cl^-$  or with  $NO_3^-$ , the parameter of this interaction is not required in equation (4-16) for the calculation of the activity coefficients of the considered species.

Since calculations are done on a salting-out agent free basis, it is not necessary to convert equations (4-16) and (4-18) to mole fractions, but instead the molality of the salt is used to calculate the ionic strength and the activity coefficients. In addition to the molality of the salting-out agents, only the molality of sodium originating from the sodium carboxylate (assumed to be equal to the initial molality of sodium carboxylate present in the system) is involved in the determination of the ionic strength and activity coefficients. The influence of the other ionic species is neglected.

#### 4.3.1.3 Mole and charge balances

Besides physical and chemical equilibria, conservation of mass and charge must be fulfilled. This is also done on a salt ( $NaCl$  or  $NaNO_3$ ) free basis.

Assuming that the amounts of water and organic solvent in the vapour phase and the quantity of water consumed in reaction (4-13) are negligible, the next equations describe the mole balance of water and, if present, the organic solvent:

$$n_{H_2O}^{a,0} = n_a^{tot} \cdot x_{H_2O}^a \quad (4-19)$$

$$n_{AOS}^{o,0} = n_o^{tot} \cdot x_{AOS}^o \quad (4-20)$$

The mole balance of carboxylate is given by the following expression:

$$n_{Ac^-}^{a,0} = n_a^{tot} \cdot (x_{Ac^-}^a + x_{HAc}^a) + n_o^{tot} \cdot x_{HAc}^o + n_s \quad (4-21)$$

while for the sodium ion:

$$n_{Na^+}^{a,0} = n_a^{tot} \cdot x_{Na^+}^a \quad (4-22)$$

Finally, the charge balance in the aqueous phase is:

$$x_{Ac^-}^a + x_{HCO_3^-}^a + 2x_{CO_3^{2-}}^a + x_{OH^-}^a = x_{H^+}^a + x_{Na^+}^a \quad (4-23)$$

where  $n_{H_2O}^{a,0}$ ,  $n_{AOS}^{o,0}$ ,  $n_{Ac^-}^{a,0}$  and  $n_{Na^+}^{a,0}$  are the initial numbers of moles of water, apolar organic solvent, carboxylate and sodium ion, respectively,  $n_a^{tot}$  and  $n_o^{tot}$  are the total numbers of moles of aqueous and organic phase, whereas  $n_s$  is the number of moles of the newly formed solid or liquid phase ( $n_s$  is equal to zero if no new solid or liquid phase is formed).

Finally, to complete the set of equation required to describe the system, the sum of mole fractions in each phase must be equal to one:

$$\sum_i x_i^a = 1 \quad (4-24)$$

$$\sum_i x_i^o = 1 \quad (4-25)$$

$$\sum_i y_i = 1 \quad (4-26)$$

#### 4.3.1.4 Recovery of extracted acid

When the system of above listed equations has been solved (see Section 4.3.1.5 for the equations composing the system for each recovery case) and the mole fraction of each component is determined, the degree of recovery of carboxylic acid can be calculated. It is defined as the ratio of the number of moles of carboxylic acid that is removed from the aqueous phase and the initial number of moles of the carboxylate in the aqueous phase in percents:

$$R = \frac{n_{Ac^-}^0 - (n_{Ac^-}^a + n_{HAc}^a)}{n_{Ac^-}^0} \cdot 100\% \quad (4-27)$$

For the recovery by back-extraction when capacity of the solvent has been exceeded, the recovery from the aqueous phase differs from the amount that is recovered into the organic phase. Therefore, an additional parameter is involved for those cases and it is called the recovery into the organic phase:

$$R^o = \frac{n_{HAc}^o}{n_{Ac^-}^o} \cdot 100\% \quad (4-28)$$

#### 4.3.1.5 Model implementation

For the recovery cases E and D, as they are listed at the beginning of the Section 4.3.1, the system of equations (4-1) to (4-4), (4-7), (4-8), (4-10), (4-11b), (4-12a) to (4-14a) and (4-19) to (4-26) has to be solved. The cases A and B require equations (4-1), (4-3), (4-7), (4-11b), (4-12a) to (4-14a), (4-19), (4-21) to (4-24) and (4-26), whereas for case C the system of equations (4-1), (4-3), (4-6), (4-7), (4-9), (4-11b), (4-12a) to (4-14a), (4-15) to (4-19), (4-21) to (4-23), (4-24) and (4-26) is necessary.

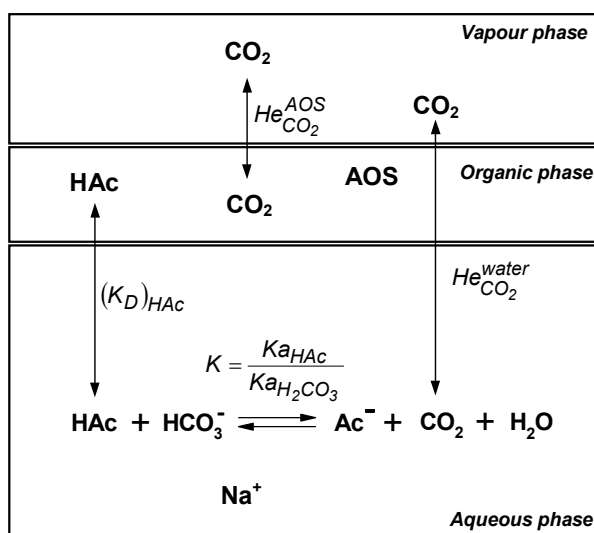
The system of equations is solved in Mathcad 8 Professional (MathSoft, USA) software. A solution of the system of equations is in each case found with a tolerance of  $10^{-9}$ .

#### 4.3.2 Carboxylic acid extraction

The considered phase and reaction equilibria in the extraction of the carboxylic acid are shown in Figure 4.4. In addition to the simplifications made in the back-recovery model introduced in the previous section, it is also assumed that the vapour phase consists of carbon dioxide only, and that dissociation of hydrogen carbonate and water (equations 3-11 and 3-14) could be neglected. Therefore, only the reactions (4-12) and (4-13) are considered to occur in the aqueous phase and they could be joined in an overall reaction as shown in Figure 4.4 having the reaction equilibrium constant equal to:

$$K = \frac{K_{HAc}}{K_{CO_2}} \quad (4-29)$$

These assumptions should have no significant influence on the value of the overall distribution ratio of carboxylic acid, which is the only parameter of interest.



**Figure 4.4** Scheme of the considered equilibria in the extraction of carboxylic acids (the used symbols are defined in Figure 4.3 and equations (4-1), (4-2), (4-10), (4-12a) and (4-13a)).

As in the back-recovery model, Henry's law (equations (4-1) and (4-2)) is used to describe the vapour-liquid equilibria of carbon dioxide. The physical distribution of the carboxylic acid between the two liquid phases is characterised by equation (4-10), whereas equations



(4-12a) and (4-13a) are applied to describe the reaction equilibrium. The activity term present in those equations is taken to be equal to 1.

Furthermore, the following mole balances are introduced to complete the description of the system considering a closed system, i.e. that the generated carbon dioxide stays in liquid and the headspace). For carboxylic acid:

$$n_{HAc}^{o,o} = n_{HAc}^a + n_{HAc}^o + n_{Ac^-} \quad (4-30)$$

The generated amount of carboxylate is equal to the generated amount of carbon dioxide:

$$n_{Ac^-} = n_{CO_2}^a + n_{CO_2}^o + \frac{p_{CO_2} \cdot V_h}{R \cdot T} \quad (4-31)$$

And finally, for the hydrogen carbonate:

$$n_{HCO_3^-}^{a,o} = n_{CO_2}^a + n_{CO_2}^o + \frac{p_{CO_2} \cdot V_h}{R \cdot T} + n_{HCO_3^-} \quad (4-32)$$

$n_{HAc}^{o,o}$  and  $n_{HCO_3^-}^{a,o}$  are the initial number of moles of carboxylic acid in the organic phase and hydrogen carbonate in the aqueous phase, respectively.  $n_{HAc}^a$ ,  $n_{HAc}^o$ ,  $n_{CO_2}^a$  and  $n_{CO_2}^o$  are the numbers of moles of carboxylic acid and carbon dioxide in the aqueous and organic phases.  $n_{Ac^-}$  and  $n_{HCO_3^-}$  are the numbers of moles of the carboxylate and hydrogen carbonate in the aqueous phase.  $p_{CO_2}$  is the partial pressure of carbon dioxide in the vapour phase  $V_h$  is the volume of the headspace in the vessel (in each experiment it is 20 ml), whereas  $R$  and  $T$  are the universal gas constant and the absolute temperature.

#### 4.3.2.1 Overall distribution ratio

Having solved the system of equations (4-1) - (4-2), (4-10), (4-12a), (4-13a) and (4-29)-(4-32), the overall distribution ratio of carboxylic acid ( $D_{HAc}$ ) is calculated as:

$$D_{HAc} = \frac{c_{HAc}^a + c_{Ac^-}^a}{c_{HAc}^o} \quad (4-33)$$

where  $c_i$  is the concentration of a solute  $i$  in the aqueous or organic phase. The distribution ratio is given as the ratio of concentrations in the aqueous and organic phases because in this case the aqueous phase is the extract and the organic is the raffinate.

The overall distribution ratio is calculated as the ratio of concentrations, and not in mole fractions as it is worked with in the back-recovery model. This is done because the results of the equilibrium experiments are acquired in concentrations and it is more convenient to apply them directly rather than to do the conversions. Thus, equations (4-1) - (4-2), (4-10), (4-12a) and (4-13a) are modified to work with concentrations. This is done by using the expressions  $c_i^a = (x_i^a / x_{H_2O}^a) \cdot c_{H_2O}^a$  or  $c_i^o = (x_i^o / x_{AOS}^o) \cdot c_{AOS}^o$ , where  $c_{H_2O}^a$  is the concentration of water in the aqueous phase (taken to be 55.6 mol/l).

#### 4.3.2.2 Model implementation

This model is also implemented in Mathcad 8 Professional (MathSoft, USA) software. A solution of the system of equations is found with a tolerance of  $10^{-3}$  (all parameters are expressed in SI system units).

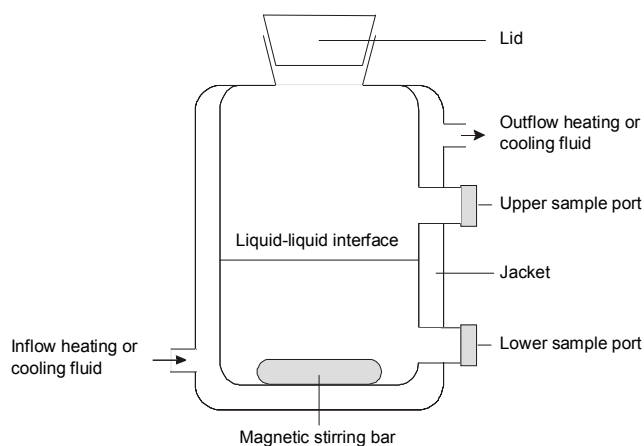
## 4.4 Experimental section

### 4.4.1 Chemicals

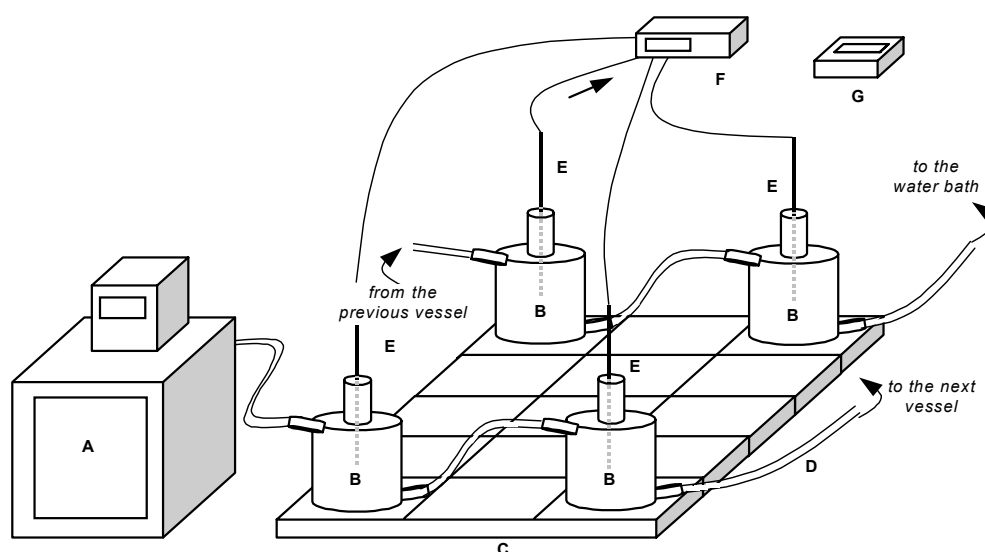
Benzoic acid (purity > 99%), hexanoic acid (purity > 98%), decanoic acid (purity > 98%), benzaldehyde (purity > 99%), toluene (purity 99.5%), benzyl alcohol (purity > 99.5%), n-hexane (purity > 99%), sodium hydrogen carbonate (purity > 99.7%), sodium chloride (purity > 99.5%), sodium nitrate (purity > 99.5%), ethanol (purity > 99.8%) and hydrochloric acid (32% in water) were supplied by Merck (Germany), sodium benzoate (purity > 99%), n-decane (purity > 99%) and dibenzofuran (purity 98%) by Acros Organics (Belgium) and sodium hexanoate (purity > 99%) by Sigma-Aldrich (USA). Carbon dioxide had 99.6% purity. All chemicals were used as received. MilliQ water was used in all experiments.

### 4.4.2 Extraction equilibrium measurements

The distribution ratio of the carboxylic acid between the aqueous and organic phase has been measured in a jacketed glass cell. A series of four cells is used. The scheme of a cell is shown in Figure 4.5, while the whole setup is given in Figure 4.6.



**Figure 4.5** Jacketed glass cell used for liquid-liquid equilibrium measurements.



**Figure 4.6** Scheme of the setup used for the liquid-liquid equilibrium measurements: A, heating/cooling circulating bath; B, jacketed glass cell; C, multiple point magnetic stirrer; D, plastic tube; E, RTD (Resistance Temperature Device) probe; F, multimeter; G, stirring remote control.

The jacketed cell has an inner chamber of about 100 ml and is equipped with two sampling ports, one in the upper half and the other in the lower half of the cell, allowing sampling of both phases. The jacket is connected to a Julabo's heating/cooling circulating bath (Julabo Labortechnik, Germany), where water is used as the heating/cooling fluid. Four cells have been connected in series to the bath allowing up to four parallel measurements. The cells are placed on the plate of a multiple point magnetic stirrer (H+P Labortechnik, Germany) and adequate magnetic bars are used for agitation.

Equilibrium measurements were performed as follows. 40 ml of the organic and 40 ml of the aqueous solutions were introduced in the vessel. The mass fraction of carboxylic acid in the initial organic solution was 1.5 wt%, while the initial concentration of sodium hydrogen carbonate in the aqueous phase varied between 0 and its solubility concentration (around 1.1 mol/l). After introduction of the solutions, the lid is put in its place and the mixture was stirred at 450 rpm at an alternating regime of 30 s stirring in one direction, 5 s pause and 30 s stirring in the other direction. It has to be emphasised that the vessel was closed by the lid such that carbon dioxide could not leave the system. After agitation (the time of agitation required to reach equilibrium was determined prior to equilibrium experiments) the mixture was left to settle for 1 h, which was found sufficient to achieve a good phase separation. During agitation and settling, the temperature of the fluid in the vessels was kept constant at the required value with an uncertainty of 0.05 °C. After the phases have settled, 1 to 2 ml samples of both the organic and the aqueous layer were taken for quantitative analysis. The distribution ratio of the acid was calculated by dividing the determined concentration of carboxylic acid in the aqueous phase (includes both the concentration of the undissociated and dissociated acid) with the determined acid concentration in the organic phase. The difference of the total amount of the carboxylic acid experimentally found in the system at equilibrium and the initial amount of the carboxylate present in the aqueous phase before extraction was not larger than 2.5%.

#### 4.4.3 Carbon dioxide aided back-recovery measurements

The back-recovery experiments were performed on the setup shown in Figure 4.7.

A jacketed stainless steel pressure vessel of 1 l with a maximum working pressure of 60 bar and maximum working temperature of 250 °C (Buchi, Switzerland) is the base of the setup. This vessel has two side-windows (W) through which the eventual new phase formation or other phenomena can be observed, a motor-driven stirrer (S) with a maximum rotation speed of 3000 rpm and a drainage port (DP). The vessel's lid has several openings through which two sampling ports (SP1 and SP2), a carbon dioxide (GIP) and a liquid introduction port (LIP), a pressure release port (RP) and two safety pressure release ports (RSP and RDP), a manometer (P), a PT-100 temperature probe (T) and a pH sensor (pH) are built in.

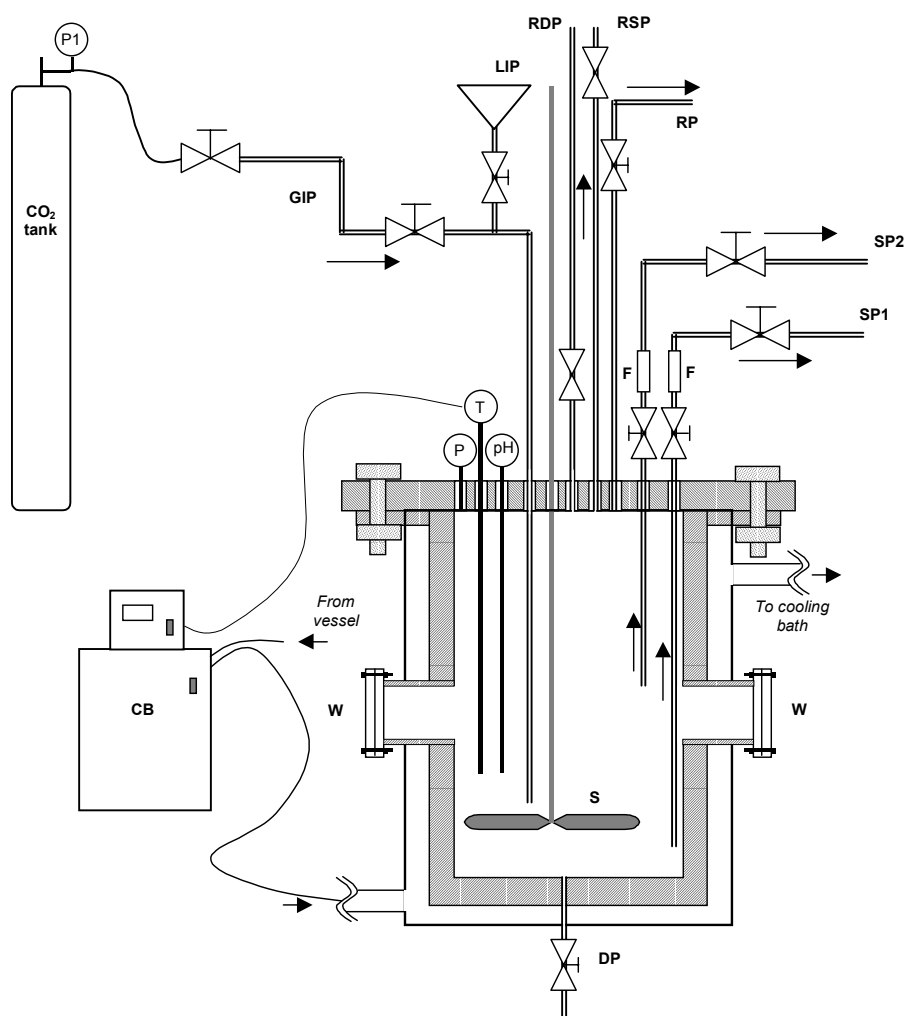
The temperature probe is connected to a Julabo's circulating bath (CB) (Julabo Labortechnik, Germany) allowing control of the temperature inside the vessel (uncertainty of 0.05 °C at 25 °C), whereas the Mettler-Toledo's (Mettler-Toledo, Switzerland) pH sensor (uncertainty of 0.25 pH units at pH 7), made for work under pressure, is connected to an adequate pH reader. A manometer (Econosto, The Netherlands) indicated pressure in the vessel with an uncertainty of 1.3 bar.

The sampling ports were made of stainless steel tubing, a fast-opening ball valve, a T-type filter and a bonnet needle valve. One sampling port (SP1) is submerged close to the bottom of the vessel, allowing sampling of the heavier phase, while the other (SP2), positioned in the upper part, allows sampling of the upper liquid phase, when present. The T-type filter

(F), having 0.5  $\mu\text{m}$  sintered filter elements, separates solids from liquid during the sampling. A valve which can be opened almost instantaneously is placed in front of the filter to allow filtration with no pressure loss during the sampling, while the valve after the filter is chosen as a regulating valve to prevent unintentional large-flow fluid releases.

The two safety ports are equipped either with a relief spring valve or with a rupture disc allowing a pressure release in case the maximum working pressure is exceeded. The liquid introduction and gas introduction port are entering the vessel through the same tube due to the limited number of openings in the lid. Therefore, the valve on the liquid port has to be closed when gas is introduced, and opposite.

To protect the experimentator, removable transparent safety shields are placed around the vessel.



**Figure 4.7** Scheme of the experimental setup for carbon dioxide aided back-recovery measurements: S, stirrer; W, side window; CB, circulating bath; DP, vessel drainage port; SP1, SP2, sampling ports; RP, pressure release port; RSP, safety pressure release port equipped with a spring valve; RDP, safety pressure release port equipped with a rupture disc; LIP, liquid introduction port; GIP, gas introduction port; F, filter; T, temperature probe; P, P1, manometers; pH, pH probe.

The back-recovery experiments were performed as follows. The liquids (the aqueous carboxylate solution and, for experiments with back-extraction, also the organic solvent) were fed into the vessel through the funnel on the liquid introduction port (LIP). To allow liquid flow, the valve at the (RP) port had to be kept open. In case two liquid phases were present and both had to be sampled, care was taken that the maximum volume of the lower

phase at equilibrium is not larger than 0.5 l, since otherwise the sampling port (SP2) would be also submerged in the heavier liquid. Also, the total liquid volume in the vessel had to be between the minimum (determined by the sampling tubes position, the height of the side window if visual observation was required, and by the depth at which the pH and temperature probe are submerged) and the maximum liquid volume at equilibrium (determined by the vessel capacity or by the height of the side windows).

After introduction of the liquids, the air from the headspace has been removed by flushing carbon dioxide through the vessel. Then, the stirring at 1500 was initiated and the temperature was set to the required value on the circulating bath after which the flow of the cooling/heating liquid was commenced. The cooling/heating fluid was a commercial car engine antifreeze. Pressurisation of the vessel was done by opening the valve on the carbon dioxide introduction port (GIP) and by introducing the gas until the required pressure inside the vessel was reached. Due to the consumption of carbon dioxide during the recovery, the pressure would drop after some time and further addition of the gas had to be done to maintain the required pressure in the headspace.

In case when a layer of liquid carbon dioxide had to be formed (for the experiments with liquid carbon dioxide as a back-extraction solvent), the introduction of carbon dioxide had to be followed by cooling and this sequence was repeated until the required volume of liquid carbon dioxide inside the vessel was formed.

After introduction of carbon dioxide, the system is left to reach equilibrium, which is assumed when there were no variations in pressure, temperature or pH. The equilibration time was in the range of 1 to 6 h, depending on the type of recovery. The shortest equilibration time was noticed for experiments with recovery by a new phase formation, while longer times were characteristic for the recovery by back-extraction due to the larger amount of carbon dioxide spent in this process.

After equilibrium was established and phases settled, the sampling was performed, but before that the potential appearance of a new phase, solid or liquid, was checked by visual observation. By opening the ball valve on a sampling port, liquid was pushed up due to the pressure difference and it could be collected on the port's outlet. In case a suspension was formed, like during the recovery of benzoic acid by new phase formation, the solids were separated from the liquid on the filter. This allowed the determination of the recovered amount.

For the recovery by back-extraction, when two liquid phases were present, first a sample of the upper and then a sample of the lower phase was taken. However, the samples of the organic phase were withdrawn only in the experiments at low pressures (not higher than 5 bar) and low carboxylate concentrations (6 wt%). At higher pressures, in the experiments involving benzoic acid recovery, a precipitation of benzoic acid is noticed at the exit of the organic phase sampling port. It is concluded that the pressure decrease during the sampling causes acid precipitation due to the cooling of the fluid (solubility is lower at a lower temperature). This was not the case for the aqueous phase samples since it contained mainly highly-soluble carboxylate, but also because heat capacity of water is much higher than of the organic solvents. Similar problem is foreseen for the recovery of hexanoic acid. Therefore, in the most cases, only the samples of aqueous phase were taken. To be sure that there are no unexpected losses during the establishment of the equilibrium, it is confirmed that the mass balance is satisfied in the low-pressure and low-carboxylate-content experiments. In those cases, the amount of the carboxylate introduced in the system did not differ from the amount found in the two phases at equilibrium more than 3%. When the upper phase was liquid carbon dioxide, a sample of that phase could not be taken in any case, due to the evaporation of CO<sub>2</sub> at the port's outlet.

Approximately 5 to 10 ml of liquid sample was taken and stored in a 10 ml glass vial. In order to obtain a representative sample of a phase, the first several millilitres of the sample were not collected and were just taken to flush the sampling port. The samples were stored until the quantitative analysis could be done. After that and if required, a new experiment using the same liquids, could be commenced. However, in that case the exact volume of sampled liquid has to be known (in order to know the volume remained in the vessel) and the filter, but also the upper part of the used sampling port, had to be cleaned before taking any sample.

After experiments were completed, the pressure was released through the port (RP) and the liquid was removed through the drainage port (DP). The vessel, but also the sampling ports were cleaned, first with ethanol and subsequently with water.

The recovery of the extracted acid was calculated using equation (4-27), from the determined total acid concentration (both the acid and the carboxylate) in the aqueous phase samples.

The solvent swelling experiments were done by introducing a known volume of it the vessel, establishing equilibrium at the same way as described above and measuring the volume of the swollen solvent at equilibrium. The volume at equilibrium was determined by measuring the height of the liquid through the side windows. The height-volume function was previously established experimentally by introducing a known volume and measuring the height of the liquid surface. The uncertainty of such a measurement was estimated to be 3 ml, which is not more than 1% of the measured volume.

#### 4.4.4 Chemical analysis

The concentrations of carboxylic acid and carboxylate in both the organic and the aqueous phase were determined by a Varian GC CP-3800 system (Varian, USA) equipped with a capillary CP-FFAP-CP column (25 m · 0.15 mm; 0.25  $\mu\text{m}$  size packing) and FID detector. During the analysis, the column temperature was raised from 100 °C to 230 °C with an increment of 17.5 °C/min and, at the end, was maintained at 230 °C for 1 min. The temperatures of detector and injector were kept constant at 300 °C and 275 °C respectively, with a pressure in the injector of 276 kPa and a split ratio of 60. Hydrogen was used as the carrier gas with an initial flow of 1.5 ml/min. The duration of an analysis was 10.58 min.

Quantification of the amount of carboxylic acid and carboxylate in a sample was done by using dibenzofuran as an internal standard. Therefore, 200  $\mu\text{l}$  of the sample was transferred into an empty 2-ml vial and diluted with 1.7 ml of a 0.25 M solution of dibenzofuran. For an organic phase sample, dibenzofuran was dissolved in toluene, whereas a solution of dibenzofuran in ethanol was used for aqueous phase samples (toluene couldn't be used for dissolution of the aqueous samples). Furthermore, before dissolving the aqueous phase sample, 30  $\mu\text{l}$  of hydrochloric acid was introduced to protonate all carboxylate into carboxylic acid. Only the latter could be analysed by applied analytical method. Therefore, only the total amount of carboxylate and carboxylic acid was measured in the aqueous phase. Addition of hydrochloric acid causes protonation of carboxylate, but also the generation of solids of sodium chloride. Hence, those samples were left overnight to provide that the solids settled. The liquid was taken for injection in the gas chromatograph (GC).

A sample of known concentration of benzoic acid in toluene was analysed 25 times to determine the repeatability of the GC analysis. The mean value of those analyses had an uncertainty of 1.8% (expressed as coefficient of variation).

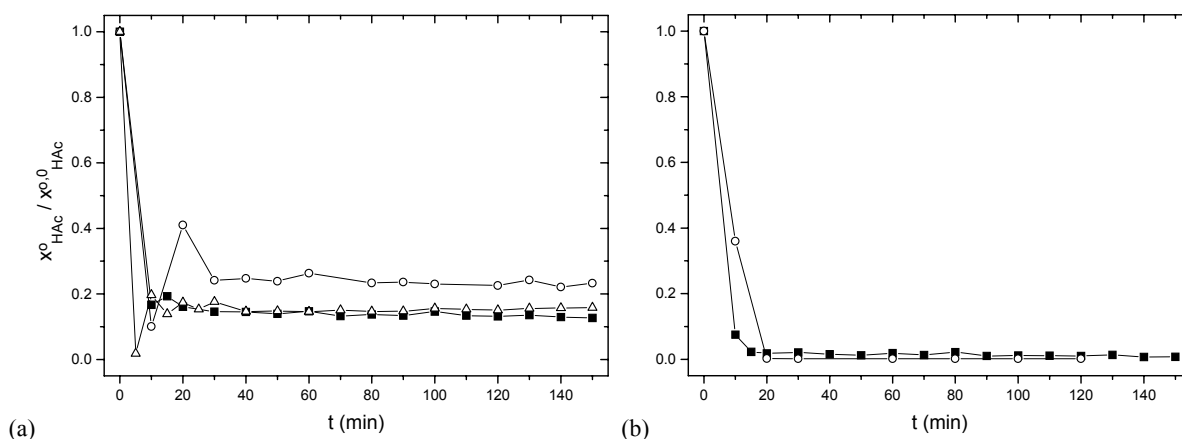
## 4.5 Results and Discussion

The experimental and model results are presented in this section. First, in Section 4.5.1, the findings on the extraction capacity of the sodium hydrogen carbonate solution are given, and then, the results on the back-recovery of the extracted acids by new phase formation (Section 4.5.2) and by back-extraction (Section 4.5.3) are discussed.

### 4.5.1 Aqueous sodium hydrogen carbonate solution as dissociation extraction solvent

#### 4.5.1.1 Equilibration time

Prior to the equilibrium measurements, the agitation time required to reach equilibrium for the specific experimental conditions is determined for extraction of different carboxylic acids. Therefore, the change in concentration of an acid in the organic phase is monitored as a function of time. This is done for two different initial concentrations of sodium hydrogen carbonate, as shown in Figure 4.8.



**Figure 4.8** The change of concentration of a carboxylic acid in the organic phase as a function of the agitation time at 20 °C for an initial sodium hydrogen carbonate concentration of (a) 0.1 mol/l and (b) 1 mol/l: ■, benzoic acid in toluene; ○, hexanoic acid in n-hexane; △, decanoic acid in n-decane.  $w_{HAC}^{o,0} = 1.5 \text{ wt}\%$  ( $c_{HAC}^{o,0} = 0.1 \text{ M}$ ).

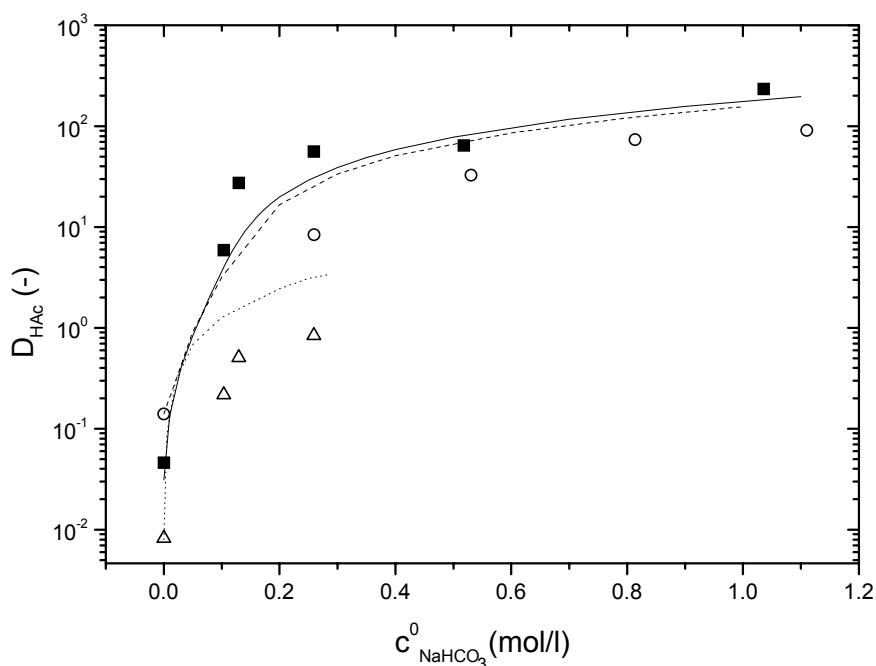
No significant difference in the equilibration time for different initial concentrations of sodium hydrogen carbonate is noticed. In both cases, and for all three acids, the equilibrium is established already after 50 min of agitation. However, to be on the safe side, an agitation time of 120 min is used in all performed extraction equilibrium experiments.

#### 4.5.1.2 Capacity of solvent toward different carboxylic acids

Experimentally determined equilibrium distribution ratios for all three considered acids, between the aqueous sodium hydrogen carbonate solution and an adequate organic solvent, are shown in Figure 4.9. The points represent the experimental data, whereas the lines are the model results. All used model parameters, except the physical distribution ratios of decanoic and hexanoic acids, are listed in Appendix A1. The mentioned physical distribution ratios are determined from the equilibrium experiments in which pure water was the extraction solvent. A value of  $(1.4 \pm 0.2) \cdot 10^{-1}$  is found for hexanoic [ $(K_D)_{HexAc}$ ] and  $(8 \pm 3) \cdot 10^{-3}$  for decanoic acid [ $(K_D)_{DecAc}$ ], for the conditions described in Figure 4.9.

It is important to emphasise that the shown results represent the equilibrium established in a closed system. In such case the carbon dioxide concentration in the aqueous phase is higher than it would be if generated  $\text{CO}_2$  was continuously removed from the vapour and, on that

way, from both liquid phases (for example, by flushing the headspace with air). Hence, in an open system, the values of the overall distribution ratio would be even higher than those shown in Figure 4.9.



**Figure 4.9** Equilibrium distribution ratio of carboxylic acid between an aqueous  $\text{NaHCO}_3$  solution and an organic solvent as a function of the initial  $\text{NaHCO}_3$  concentration in the aqueous phase at 20 °C: ■ and ○, benzoic acid (organic solvent: toluene), ○ and ---, hexanoic (organic solvent: n-hexane) and Δ and ···, decanoic acid (organic solvent: n-decane).  $w_{\text{HAc}}^{o,o} = 1.5 \text{ wt\%}$  ( $c_{\text{HAc}}^{o,o} = 0.1 \text{ mol/l}$ ). S/F = 1.

Although in all cases sodium hydrogen carbonate causes a significant enhancement of the acid distribution ratio compared to the pure water, reached maximum depends on the acid. It varies from around 0.7 for decanoic acid, to around 200 for benzoic and hexanoic acid.

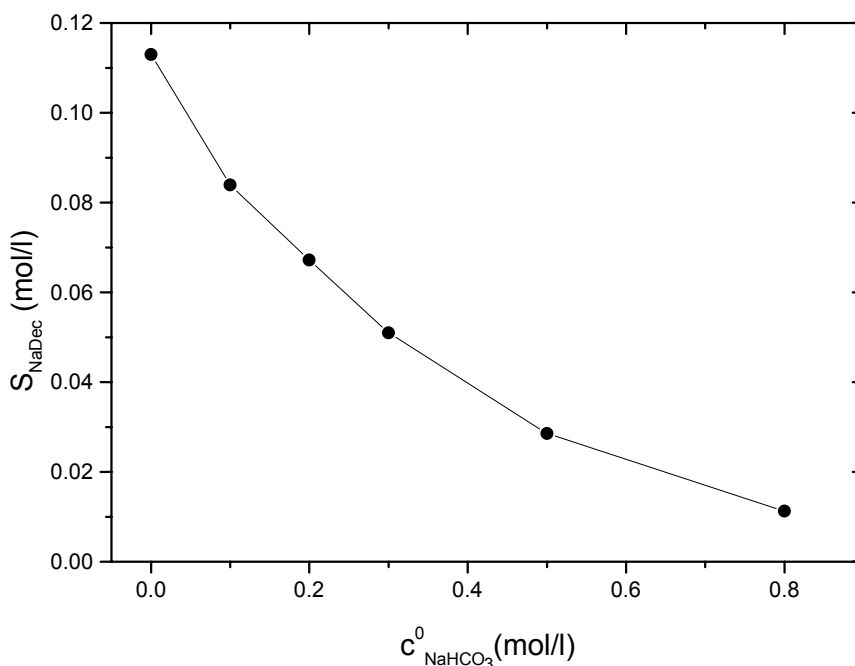
Two parameters of the feed are determining the value of the distribution ratio. First, the value of the acid dissociation constant ( $K_{a_{\text{HAc}}}$ ) and, second, Henry's coefficient of carbon dioxide for the organic solvent ( $He_{\text{CO}_2}^{\text{AOS}}$ ). As the value of  $K_{a_{\text{HAc}}}$  is higher, a higher distribution ratio is achieved. However, having low  $He_{\text{CO}_2}^{\text{AOS}}$  more  $\text{CO}_2$  dissolves in the organic solvent and less in the aqueous phase, causing more intensive shift of the dissociation equilibrium to the right. This results in higher values of the distribution ratio. Therefore, besides the acid dissociation constant, the solubility of carbon dioxide in the organic solvent also determines the distribution ratio in a closed extraction system.

When comparing the distribution ratios of benzoic and hexanoic acids,  $He_{\text{CO}_2}^{\text{AOS}}$  for both solvents is similar, and the difference comes mainly from the 5 times higher dissociation constant of benzoic acid. The physical distribution ratio ( $K_{(D)}_{\text{HAc}}$ ) also has a certain effect, especially in the initial part of the curve, but the influence of the previous two seems to be more significant.

Explanation for the low values of the decanoic acid distribution ratio could be found not in its dissociation constant, which is close to that of hexanoic acid, but in the high value of Henry's coefficient of  $\text{CO}_2$  for n-decane. This coefficient is almost two times higher than for either toluene or n-hexane. The distribution ratio of decanoic acid is not shown for the concentrations of sodium hydrogen carbonate higher than 0.3 mol/l due to the formation of a



precipitate. It is assumed that the precipitate could be sodium decanoate salted-out by  $\text{NaHCO}_3$ . This assumption is evaluated by preparing  $\text{NaHCO}_3$  solutions of several different concentrations and dissolving sodium decanoate in them until no more could be dissolved. The maximum dissolved concentration is taken as the solubility. The results are shown in Figure 4.10, where the points represent the experimental results and the line shows their trend. As can be seen, salting-out of sodium decanoate by  $\text{NaHCO}_3$  is rather strong. The same effect could be expected also for benzoate and hexanoate. However, the solubility of benzoate in pure water, for example, is around ten times higher than the measured solubility of decanoate. Therefore, no precipitation occur at those cases, at least not in the concentration range evaluated in this work. In conclusion, it should be kept in mind that the applicability of a sodium hydrogen carbonate solution for extraction of a carboxylic acid is limited by the solubility of its salt in the aqueous phase.



**Figure 4.10** Solubility of sodium decanoate ( $S_{\text{NaDec}}$ ) in aqueous solution of  $\text{NaHCO}_3$  at 20 °C as a function of the initial sodium hydrogen carbonate concentration ( $C^0_{\text{NaHCO}_3}$ ).

Figure 4.9 shows a reasonable agreement of the model predictions and the experimental results for all three acids. Therefore, if required parameters are available, the model can be used to predict the value of the overall distribution ratio of an acid between an aqueous  $\text{NaHCO}_3$  solution and an organic solvent.

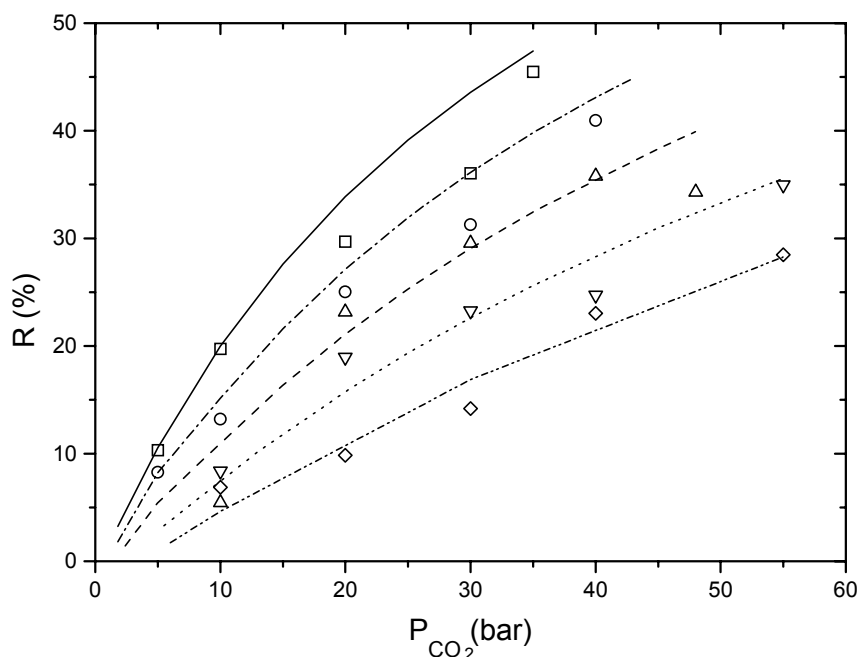
#### 4.5.2 Carbon dioxide aided back-recovery by new phase formation

The results on the recovery of benzoic acid by precipitation and of hexanoic acid by a new liquid phase formation from pure sodium carboxylate solutions are reported in Section 4.5.2.1. The findings on the recovery of benzoic acid by precipitation from a solution which contained a salting-out electrolyte, i.e. sodium chloride or sodium nitrate, are given in Section 4.5.2.2.

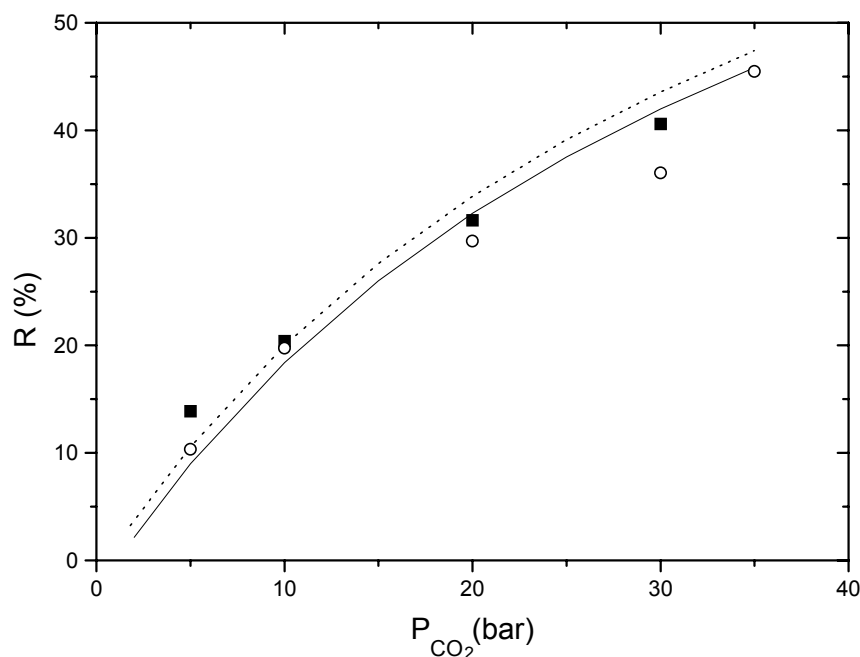
##### 4.5.2.1 Pure carboxylate solution

Figure 4.11 shows the recovery of benzoic acid as a function of pressure for various temperatures, whereas in Figure 4.12 the dependence on the initial mass fraction of benzoate

in the aqueous phase ( $w_i^{a,0}$ ) is given. Figure 4.14 presents the results on the recovery of hexanoic acid. Again, the points represent the experimental and the lines model predictions (relevant model parameters are listed in Appendix A1).



**Figure 4.11** Equilibrium recovery of benzoic acid by precipitation as a function of the  $\text{CO}_2$  pressure at various temperatures:  $\square$  and —, 5 °C;  $\circ$  and ---, 10 °C;  $\Delta$  and -·-, 15 °C;  $\nabla$  and ···, 20 °C,  $\diamond$  and - - - 25 °C.  $w_{\text{NaBen}}^{a,0} = 12 \text{ wt}\%$ .

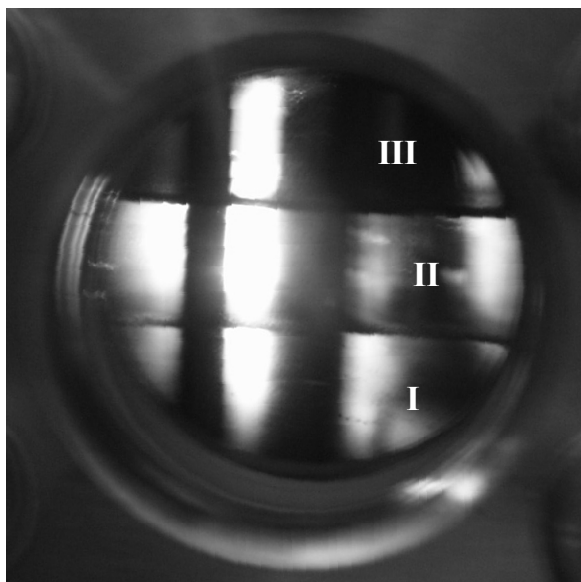


**Figure 4.12** Equilibrium recovery of benzoic acid by precipitation as a function of  $\text{CO}_2$  pressure for different  $w_{\text{NaBen}}^{a,0}$  at 5 °C:  $\blacksquare$  and —, 6 wt%;  $\circ$  and ···, 12 wt%.

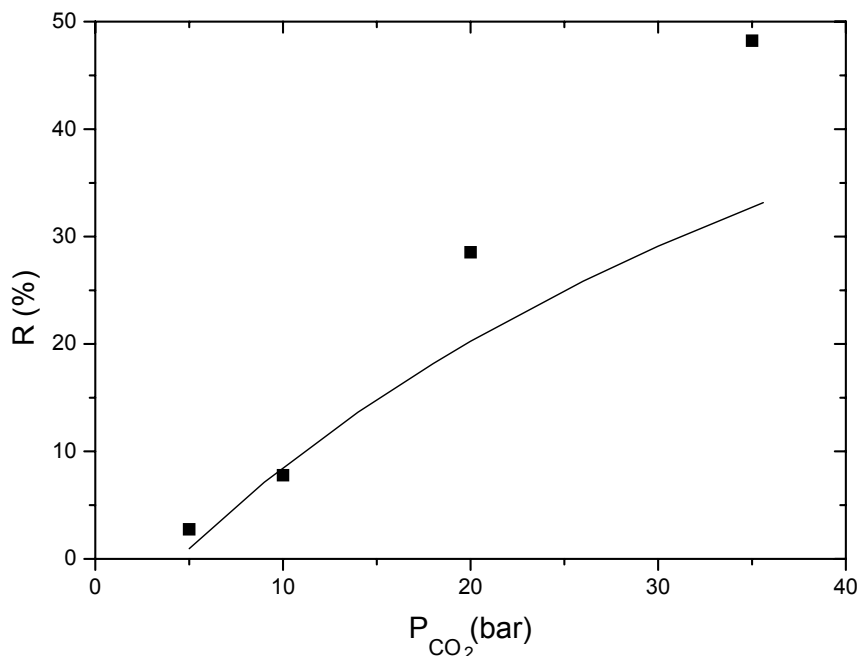
Suspended solids are noticed in all performed equilibrium experiments involving benzoic acid ( $5 < P < 55 \text{ bar}$ ,  $5 < T < 25 \text{ °C}$ ), whereas new liquid phase, lighter than water, appeared in each experiment in which the recovery of hexanoic acid is evaluated ( $5 < P < 45 \text{ bar}$ ,  $T = 5 \text{ or } 15 \text{ °C}$ ) [see Figure 4.13]. Qualitative analysis of the solids on the sampling port filter

confirmed that the solids are indeed benzoic acid, while, in the second case, the liquid sample analysis confirmed hexanoic acid. Therefore, this proves that  $\text{CO}_2$  under pressure can initiate generation of new acid phase.

A conclusion that the recovery increases with temperature, but also with pressure increase, can be drawn despite moderate scattering of the experimental results. Furthermore, the recovery does not differ much for different initial mass fractions of carboxylate in the aqueous phase.



**Figure 4.13** A view through the side window of the experimental vessel showing the new liquid layer of hexanoic acid: I, aqueous phase; II, hexanoic acid layer, III, vessel headspace.



**Figure 4.14** Measured and predicted equilibrium recovery of hexanoic acid by new liquid phase formation as a function of the  $\text{CO}_2$  pressure at  $5\text{ }^\circ\text{C}$ .  $w_{\text{NaHex}}^{a,0} = 12\text{ wt}\%$ .

The good agreement of the model predictions and the experimental findings confirms that the model can be applied for the estimation of the acid recovery by new phase formation at different pressures, temperatures and initial mass fractions. However, to be able to do that, it

is necessary to know all model parameters as a function of temperature as is worked out for benzoic and hexanoic acid in Appendix A1.

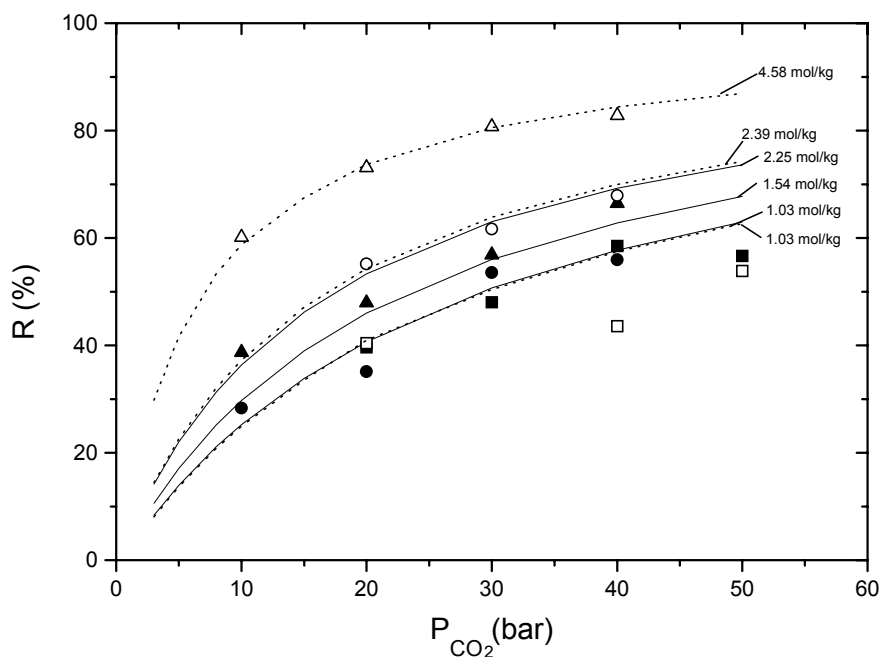
As expected, the trend of model lines is such that they increase toward an asymptote, which is determined by a theoretical recovery limit. That limit represents the recovery if all carboxylate would be converted into the acid.

The experimental results show similar recoveries for hexanoic as for benzoic acid at the same conditions. However, the model predicts somewhat lower values. This may be due to the model assumption in which the new acid-rich phase is treated as pure acid. Although that may be valid for the solid-liquid equilibrium in case of benzoic acid, in case of the liquid-liquid equilibrium in the recovery of hexanoic acid, this assumption may be too daring. If water is present in the acid phase, a higher recovery will occur. However, the consequence is a decrease in purity. To be able to incorporate this phenomenon in the model, data on the solubility of water in hexanoic acid are required.

#### 4.5.2.2 Influence of a salting-out agent

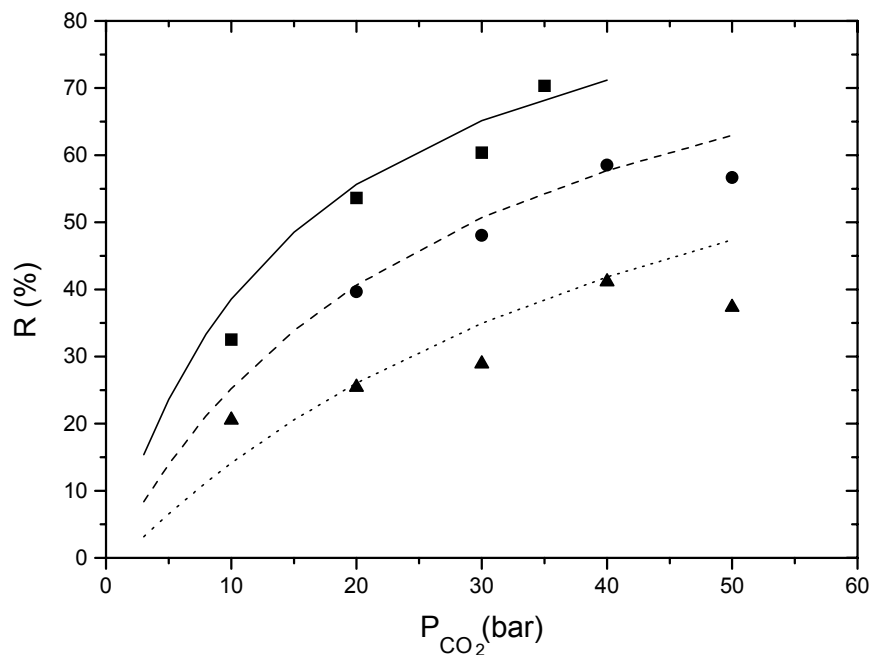
Figure 4.15 shows the results on influence of a salting-out agent and its concentration on the recovery of benzoic acid by precipitation. Furthermore, the effect of temperature is presented in Figure 4.16. The points represent experimental data and the lines are model predictions.

The presence of either sodium chloride or sodium nitrate causes a significant increase of the benzoic acid recovery (see Figure 4.11 for comparison). In the case of the highest evaluated molality of sodium nitrate (4.58 mol/kg), a maximum recovery of up to 85% is found. This is more than twice than recovered without salting-out agent. Furthermore, with a carbon dioxide pressure of only 5 bar, a recovery of 45% is already reached. As can be seen from Figure 4.15, this increase depends more on the amount of the salting-out agent (ionic strength), than on the type. However, this is the case because these two salts are salting-out agents of similar strength.



**Figure 4.15** Equilibrium recovery of benzoic acid by precipitation as a function of  $\text{CO}_2$  pressure in presence of various molalities of a salting-out agent (solid symbols and —, NaCl; open symbols and ···,  $\text{NaNO}_3$ ) at 15 °C: ■ and □, 1.03 mol/kg; ●, 1.54 mol/kg; ▲, 2.25 mol/kg; ○, 2.39 mol/kg; △, 4.58 mol/kg.  $w_{\text{NaBen}}^{a,0} = 12 \text{ wt\%}$ .

As noticed for no salting-out conditions, a decrease in temperature results in improvement of the recovery also in these solutions. The magnitude of the temperature effect is similar.

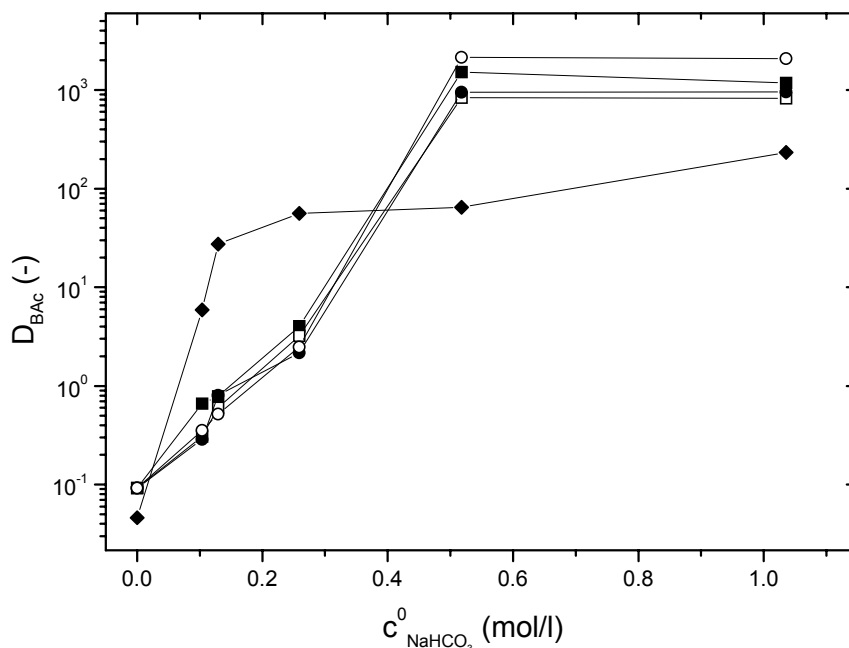


**Figure 4.16** Equilibrium recovery of benzoic acid by precipitation as a function of the  $\text{CO}_2$  pressure in presence of 1.03 mol/kg of NaCl in the aqueous solution: ■ and —, 5 °C; ● and ---, 15 °C; ▲ and ···, 25 °C.  $w_{\text{NaBen}}^{a,0} = 12 \text{ wt}\%$ .

Again, the model predictions are in very good agreement with the experiments. Hence the model can be applied also for the recovery by precipitation in presence of a salting-out agent. However, it should be mentioned that attempts to describe the effect of sodium chloride or sodium nitrate on the activity coefficients of the ionic species by simpler models than Pitzer's model (Debye-Hückel or Davies) did not have success.

To be able to judge on the applicability of salts, like sodium chloride or sodium nitrate, the effect of their presence in the aqueous solution during the extraction of carboxylic acid from an organic solvent must also be evaluated. The most attractive option would be to recycle that aqueous solution directly, with no need to remove the salt. That would be possible only if sodium chloride or sodium nitrate do not significantly diminish the extraction capacity of the aqueous solution toward the carboxylic acid. Therefore, the distribution ratio of benzoic acid has been measured in the presence of sodium chloride or sodium nitrate in the aqueous phase at different concentrations. The results are shown in Figure 4.17, where the lines are showing only the trend and are not model results.

Both salts cause a decrease of the distribution ratio in the region of lower hydrogen carbonate concentrations, but in the same time, a 10 times increase at higher concentrations. The reason for such behaviour can be found in different components being salted-out at the low and at the high  $\text{NaHCO}_3$  concentrations. The salt salts-out both benzoic acid and carbon dioxide. The salting-out of  $\text{CO}_2$  increases the distribution ratio, but the salting-out of benzoic acid decreases it. As seen before (Figure 4.15), the salting-out of benzoic acid is more pronounced than of carbon dioxide. Therefore, at the low  $\text{NaHCO}_3$  concentrations, where significant amount of benzoic acid is present, the distribution ratio is lower than for no salting-out conditions. However, as concentration of  $\text{NaHCO}_3$  increases, more benzoic acid is converted into benzoate, so only the positive salting-out effect on  $\text{CO}_2$  remains (assuming no effect on sodium benzoate).



**Figure 4.17** Equilibrium distribution ratio of benzoic acid between an aqueous solution of  $\text{NaHCO}_3$ , containing  $\text{NaCl}$  or  $\text{NaNO}_3$ , and toluene, as a function of the initial sodium hydrogen carbonate concentration in the aqueous phase at  $20\text{ }^\circ\text{C}$ : ■,  $0.1\text{ mol/l}$  of  $\text{NaCl}$ ; □,  $0.3\text{ mol/l}$  of  $\text{NaCl}$ ; ●,  $0.1\text{ mol/l}$  of  $\text{NaNO}_3$ ; ○,  $0.3\text{ mol/l}$  of  $\text{NaNO}_3$ ; ◆, no salting-out agent.  $w_{\text{BAc}}^0 = 1.5\text{ wt}\%$  ( $c_{\text{BAc}}^0 = 0.1\text{ mol/l}$ ).  $S/F = 1$ .

In conclusion, a salting-out agent has a positive effect on both, the extraction and back-recovery. Nevertheless, conditions have to be optimised concerning the initial concentration of  $\text{NaHCO}_3$ .

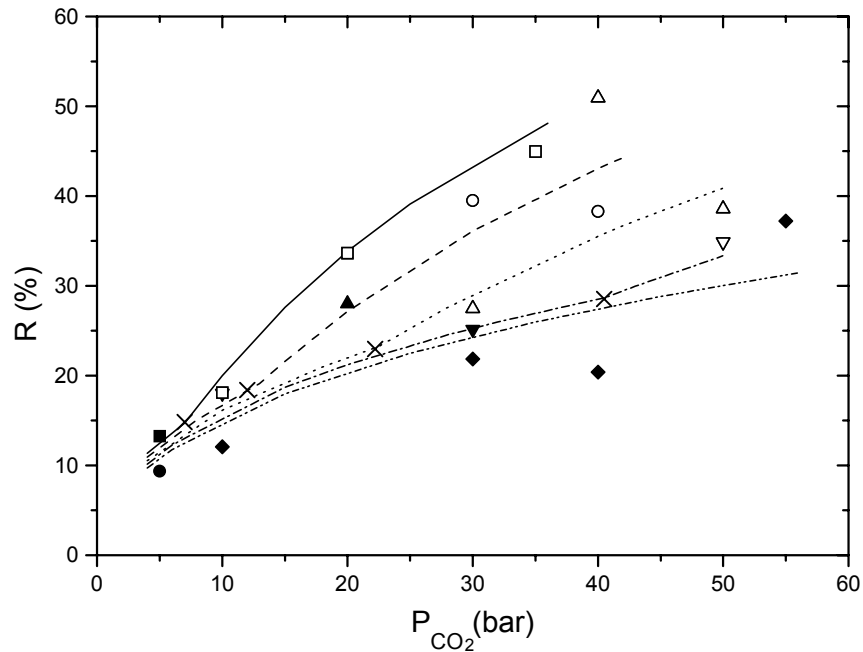
### 4.5.3 Carbon dioxide aided back-recovery by back-extraction

Results on the recovery of benzoic and hexanoic acid, as well as the findings on the swelling of the extraction solvent are discussed in this section.

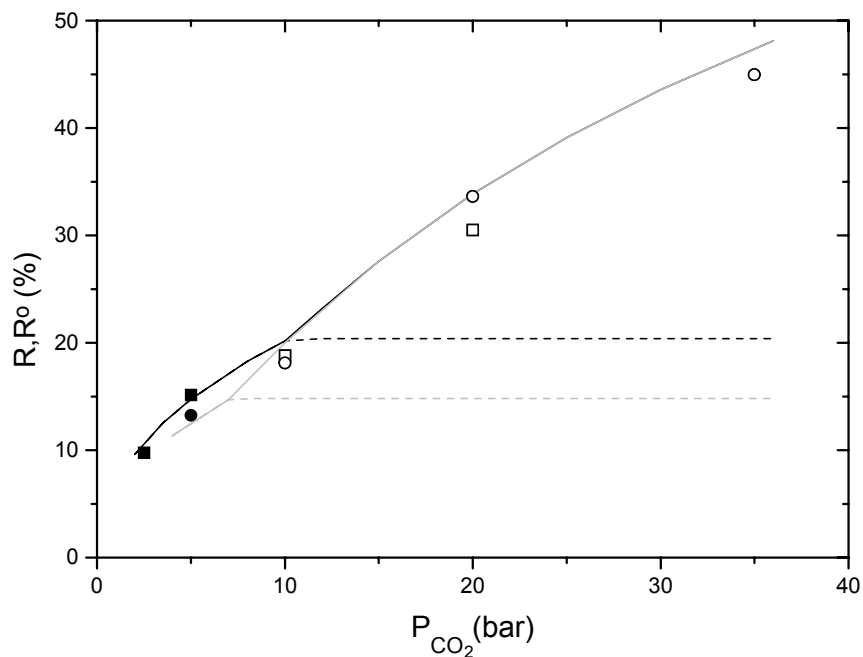
#### 4.5.3.1 Recovery

The temperature influence on the recovery of benzoic acid in toluene is shown in Figure 4.18, whereas the effects of the initial solvent-to-feed ratio ( $S/F$ ) and the initial mass fraction of benzoate are shown in Figures 4.19 and 4.20. The measured recoveries of benzoic acid achieved by different solvents are presented in Figure 4.21. Finally, the results on the recovery of hexanoic acid in  $n$ -hexane are given in Figure 4.22. In all these graphs, except in Figure 4.22, the points are experimental data and the lines represent model results. The model results in Figures 4.18 - 4.20 are predictions, whereas those in Figures 4.21 are obtained by fitting (discussed later in the text).

For the conditions described in Figure 4.18, at all temperatures but  $25\text{ }^\circ\text{C}$ , a precipitate could be seen through the side windows of the experimental vessel if the pressure exceeded a certain value. In this figure, but also in the other figures in this section describing the recovery of benzoic acid, the experimental points at which precipitation occurred are given as open symbols, whereas the solid symbols represent cases without precipitation. Again, as in the back-recovery by precipitation, it is confirmed that the solids are really benzoic acid.



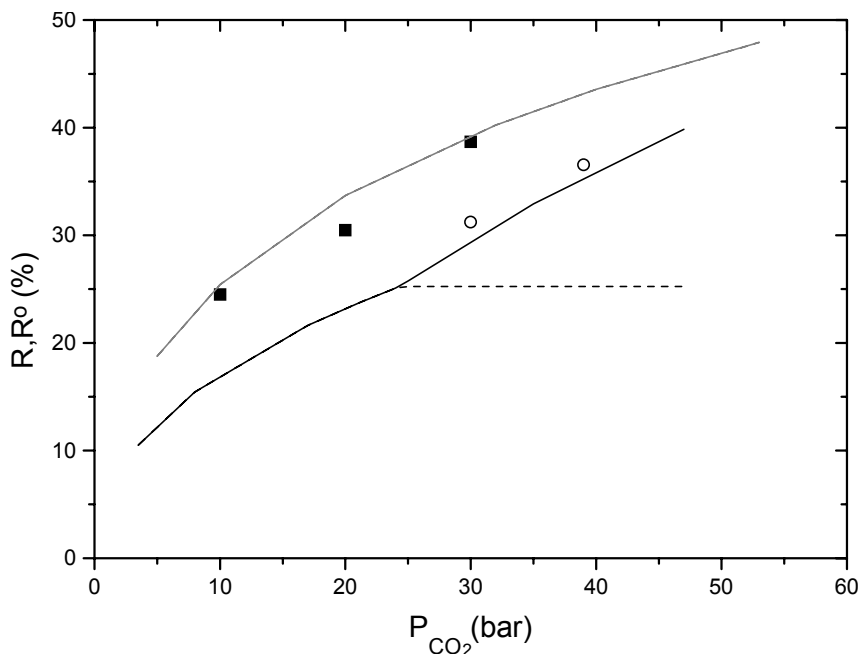
**Figure 4.18** Equilibrium recovery of benzoic acid by back-extraction in toluene as a function of the  $CO_2$  pressure at various temperatures:  $\square$ ,  $\blacksquare$  and  $\text{—}$ , 5 °C;  $\circ$ ,  $\bullet$  and  $\text{---}$ , 10 °C;  $\Delta$ ,  $\blacktriangle$  and  $\text{---}$ , 15 °C;  $\nabla$ ,  $\nabla$  and  $\text{---}$ , 20 °C,  $\blacklozenge$  and  $\text{---}$  25 °C. The x denotes the point of solvent saturation.  $w_{NaBen}^{a,0} = 12$  wt%. S/F = 0.36.



**Figure 4.19** Equilibrium recovery of benzoic acid by back-extraction in toluene as a function of the  $CO_2$  pressure for different S/F at 5 °C:  $\blacksquare$ ,  $\square$  and  $\text{—}$ , R for S/F = 0.50;  $\text{---}$ ,  $R^0$  for S/F = 0.50;  $\circ$ ,  $\bullet$  and  $\text{—}$ , R for S/F = 0.36;  $\text{---}$ ,  $R^0$  for S/F = 0.36.  $w_{NaBen}^{a,0} = 12$  wt%.

Obviously, at certain conditions the capacity of toluene is exceeded and no more benzoic acid can be dissolved in it, causing benzoic acid to precipitate. Hence, that saturation point determines the maximum recovery of benzoic acid that can be achieved by back-extraction. Anything recovered at the higher pressures may be considered as recovery by precipitation. The point of solvent saturation, if appears, is predicted by the model. In Figure 4.18 it is

marked by "x" on the model lines, whereas in the other figures its position is located at the split of the two recovery lines. One recovery line represents the recovery from the aqueous phase (into the organic solvent and eventually into precipitate) and the other, the recovery into the organic phase. At the pressures below the point of saturation, these lines overlap. At the saturation point, a slight change in the slope of the curve representing the recovery from the organic phase can be seen. The reason for this change can be found in different asymptotes toward which the curve approaches. In case of back-extraction the asymptote is determined by the physical distribution ratio of the acid, whereas in case of new phase formation, it is determined by the acid solubility in water.



**Figure 4.20** Equilibrium recovery of benzoic acid by back-extraction in toluene as a function of the  $CO_2$  pressure for different  $w_{NaBen}^{a,0}$  at 15 °C: ■ and —, R for 6 wt%; ○ and —, R for 15 wt%; ---,  $R^0$  for 15 wt%. S/F = 0.50.

The experimental results in Figure 4.18, but also in some figures that follow, show too large scattering to draw definite conclusions. However, since the model predictions follow the trend of the experimental results and the position of the saturation point predicted by the model is in a good agreement with the experimental findings, the model can be assumed trustable. Therefore, the model results are used to discuss the effects of evaluated parameters.

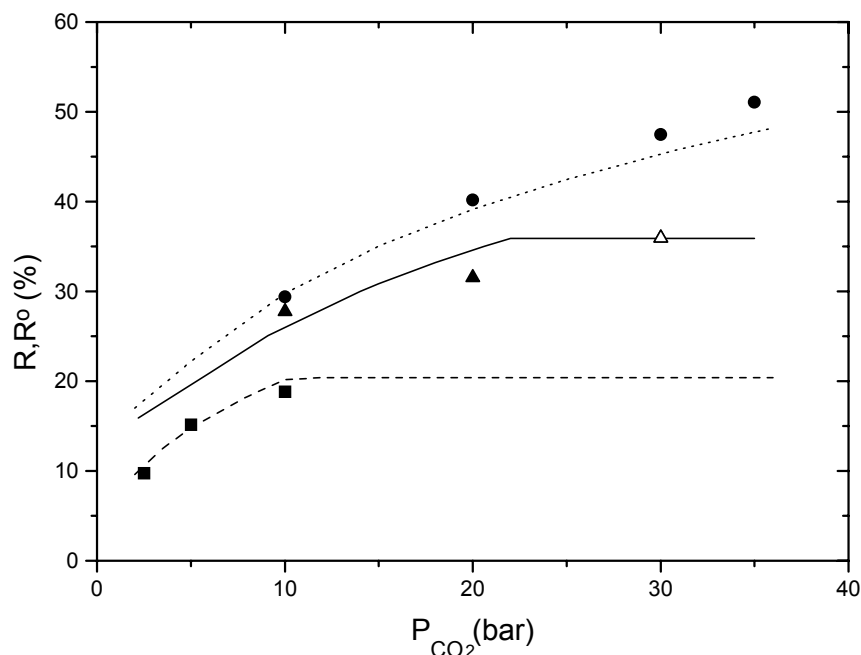
For the same pressure, below the saturation point, the recovery increases (although slightly) with decreasing temperature. However, the saturation point moves to higher recoveries as temperature increases. For example, in the evaluated temperature range of 5 - 25 °C [at S/F of 0.36], the highest recovery of benzoic acid by back-extraction is achieved at 25 °C and it is around 30%. In the same time, not more than 15% could be recovered at 5 °C.

As expected, a higher recovery can be made when increasing the initial solvent-to-feed ratio from 0.36 to 0.50, because the point of saturation occurs at a higher pressure. Thus, the maximum recovery from around 15% is increased to 20% by increasing S/F. Below the point of saturation and for the same pressure, the model predicts somewhat higher recovery for higher S/F. However, this difference can not be observed from the experimental results. The range of S/F ratios that could be experimentally evaluated is limited by the used



experimental setup (the volumes of the upper and lower phase have to be within a certain range to be able to perform sampling and to measure the pH in the aqueous solution). However, if this ratio would be increased to, for example, 1, the model predicts a maximum recovery of around 40% (at 23 bar).

As the initial mass fraction of benzoate in the aqueous phase decreases, the point of saturation moves to higher pressures. Precipitation does not occur when 6 wt% sodium benzoate solution is subjected to back-extraction using toluene at S/F of 0.50 (at 15 °C), while at 15 wt% it is noticed above 20 bar. The model agrees with these findings and predicts no saturation point for 6 wt%, in the evaluated pressure range, and one at around 25 bar for 15 wt% mass fraction (see Figure 4.20). Furthermore, it can be seen that as amount of carboxylate in the aqueous phase gets lower, a higher recovery can be achieved per equilibrium stage at the same pressure.



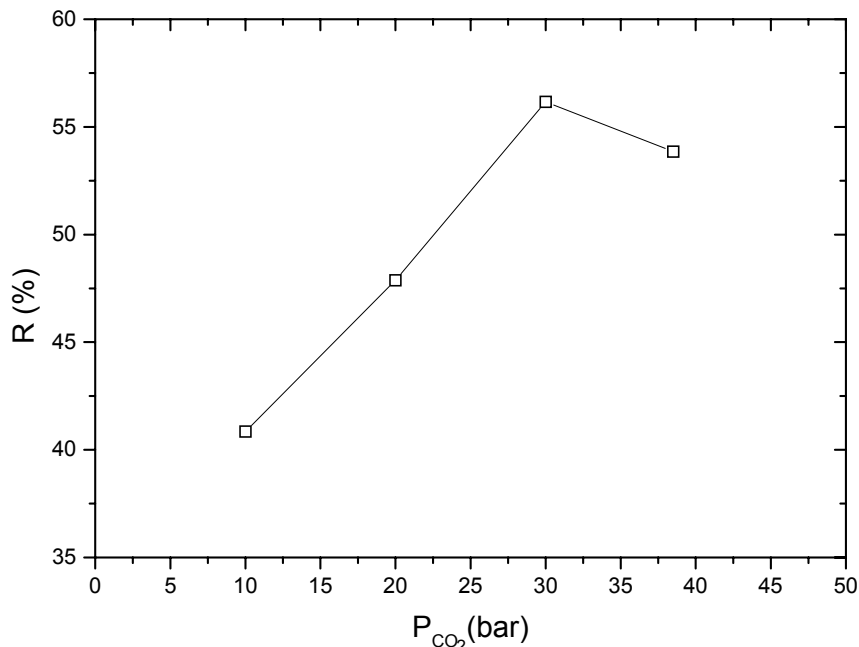
**Figure 4.21** Equilibrium recovery  $R$  of benzoic acid by back-extraction into different organic solvents at S/F of 0.50 as a function of the  $CO_2$  pressure at 5 °C: ● and ····, benzyl alcohol; ▲ and —, benzaldehyde; ■ and ---, toluene [all model lines and the point at 30 bar for benzaldehyde (Δ) represent  $R^0$ ].  $w_{NaBen}^{a,0} = 12$  wt%.

When benzyl alcohol is used as back-extraction solvent, instead of toluene, no precipitation occurs in the evaluated pressure range and conditions (see Figure 4.21). In case of benzaldehyde, solids are formed only at 30 bar, indicating that the point of saturation is between 20 and 30 bar (for toluene this point is at around 10 bar). Furthermore, the recovery achieved by either benzyl alcohol or benzaldehyde, for the same pressure, is higher than for toluene. Around 5% more is achieved using benzaldehyde, and up to 10% more using benzyl alcohol (see Figure 4.21). Since the point of saturation is moved to higher pressures, a higher maximum recovery can be obtained by benzaldehyde and even higher by benzyl alcohol. This indicates that these solvents would be better options for back-extraction solvent than toluene. However, it should be kept in mind that benzyl alcohol and water are more soluble in each other than both benzaldehyde and toluene. This would cause a loss of solvent and the presence of water in the extract. Finally, it should be mentioned that the recovery values shown in Figure 4.21 are in very good agreement with the values reported in the literature (see Section 4.2), where a similar back-extraction, but using 1-butanol as the solvent is reported.

For the back-extraction of benzoic acid in benzyl alcohol and benzaldehyde, shown in Figure 4.21, the model lines are obtained by fitting the experimental data using the established model. This had to be done since the solubility equilibrium constants of benzoic acid in these two solvents are not found in the literature. The fitting is done by minimising the sum of squares of the deviations of the fitting curve from the experimental points. It is found that the solubility equilibrium constant [ $Ks_i$ ] has value of  $(8.3 \pm 0.4) \cdot 10^{-2}$  for benzyl alcohol, and  $(6.0 \pm 0.3) \cdot 10^{-2}$  for benzaldehyde at 5 °C (for comparison, for toluene at 5 °C it is  $3.6 \cdot 10^{-2}$ ).

In Figure 4.21, the point "Δ" at 30 bar for benzaldehyde represents the measured recovery into the organic phase, and not like the other points, the recovery from the aqueous phase. Although the results on the concentrations in the organic phase are not used as reliable (see Section 4.4.3 for the explanation), in this case the organic phase concentration is the only quantitative source on which the model could determine the saturation point. Therefore, the position of the point of saturation in the benzaldehyde case should be taken just as an indication.

At all evaluated conditions at which liquid carbon dioxide is tested as the extraction solvent (38 bar at 5 °C, 41 bar at 8 °C and 45 bar at 12 °C, where the S/F ratio, calculated as the ratio of the liquid CO<sub>2</sub> volume at equilibrium and is 0.4 and the initial sodium carboxylate concentration 12 wt%), precipitation of benzoic acid is noticed. Similar is for hexanoic acid, but with formation of new liquid phase. Since no recovery into the organic phase ( $R^o$ ) could be measured at the used experimental setup, no quantitative indication on the capacity of the liquid carbon dioxide toward benzoic or hexanoic acid could be obtained. However, a conclusion that capacity of liquid carbon dioxide is not sufficient to be used as back-extraction solvent, can be drawn.



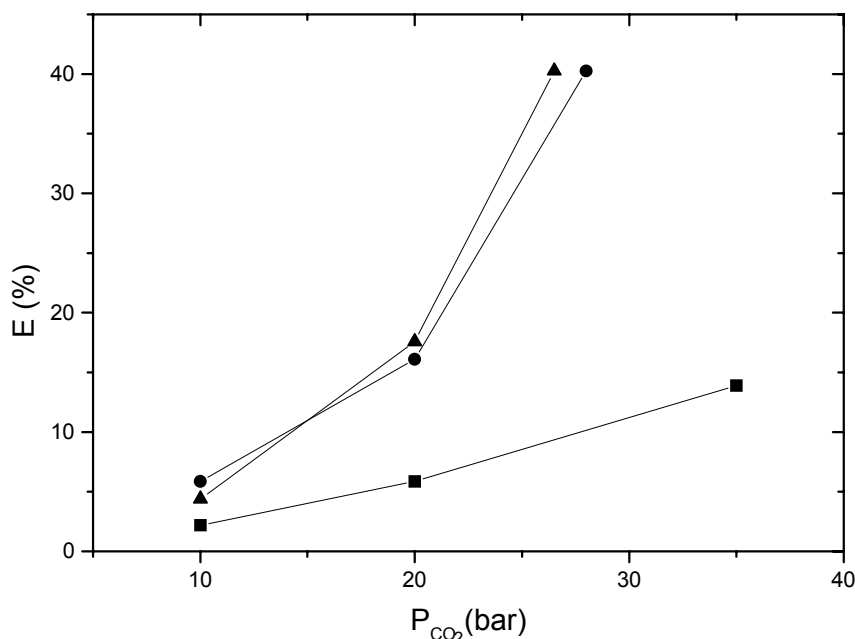
**Figure 4.22** Equilibrium recovery of hexanoic acid by back-extraction in n-hexane as a function of the CO<sub>2</sub> pressure at 15 °C.  $w_{NaHex}^{a,0} = 12$  wt%. S/F = 0.50.

In all experiments at which the back-extraction of hexanoic acid is analysed (see Figure 4.22), a third liquid phase is formed. Its analysis confirmed that it is mainly composed of hexanoic acid. This means that n-hexane has a poor capacity toward hexanoic acid and that it can't be applied as back-extraction solvent, at least not at low S/F. Hence, in this case no

pure back-extraction, but only its combination with new phase formation is found. That case would not have any practical use. Therefore no purpose is seen in trying to establish a model which is capable of describing it. So, the line in the graph is not model result. However, it is interesting to remark that the recoveries reported in Figure 4.22 are higher than those seen in Figure 4.14. Obviously, in this case n-hexane dissolves more in the new formed acid-rich phase than water, and therefore the recovery is higher. However, although the recovery is improved, the purity is further reduced.

#### 4.5.3.2 Organic solvent swelling

The experimental results on the swelling of benzyl alcohol, benzaldehyde and toluene by the uptake of CO<sub>2</sub> are shown in Figure 4.23. The swelling is measured just to give an indication on the range of solvent volume expansion. Therefore, no modelling is involved in this case and the lines connecting the experimental data are just showing their trend.



**Figure 4.23** Solvent volume expansion as a function of CO<sub>2</sub> pressure at 5 °C: ■, benzyl alcohol; ▲, toluene; ●, benzaldehyde.

The volumetric expansion, i.e. the solvent swelling ( $E$ ), is defined as percentage of the solvent volume increase at equilibrium compared to the volume of the solvent before introduction of carbon dioxide:

$$E = \frac{V - V^0}{V^0} \cdot 100\% \quad (4-34)$$

Benzaldehyde and toluene exhibited a larger expansion (up to 40%) than benzylalcohol (up to 15%). Such behaviour could be expected since the apolar carbon dioxide molecule dissolves more in the apolar than in the polar solvents, like benzyl alcohol. It should be kept in mind that some expansion of benzyl alcohol is also caused by water dissolved in it. No significant difference in the expansion behaviour of toluene and benzaldehyde is present.

## 4.6 Conclusions

An aqueous solution of a hydrogen carbonate salt seems to be an efficient extraction solvent for the recovery of a low-water soluble carboxylic acid from a dilute apolar organic

solution. In addition, carbon dioxide under pressure enables an efficient back-recovery of the extracted acid. Used in combination, these two steps provide total solution for the recovery of a carboxylic acid from an organic solution in which no unwanted salts are generated and only environmentally benign chemicals are used. This makes such an option advantageous compared to the conventional dissociation extraction process in which strong mineral acids or bases are used.

For the evaluated aromatic and aliphatic acids, the aqueous solution of sodium hydrogen carbonate enables the acid distribution ratios of up to 200. Even higher values are expected if  $\text{CO}_2$  would be continuously removed from the extraction vessel allowing the reaction equilibrium to shift to the carboxylate side even more. It is found that the equilibrium distribution ratio does not depend only on the dissociation equilibrium constant of the carboxylic acid, but also significantly on the solubility of carbon dioxide in the organic solvent from which the acid is extracted. The high values of the dissociation constant, but also high  $\text{CO}_2$  solubility in the organic solvent, favour extraction.

Both of the evaluated options for the back-recovery of the extracted acid, i.e. by a new phase formation or by back-extraction, are feasible alternatives. Equilibrium stage recoveries of around 50% for both benzoic and hexanoic acids can be achieved by new phase formation. Addition of a salting-out agent in the aqueous phase improves the recovery and may lead to an equilibrium stage recovery of up to 90%, whereas the recovery of around 50% can be achieved already at the pressure of 5 bar. In addition, the salting-out agent can even improve distribution ratio in the extraction step. Therefore, since it has positive effect on both steps of the recovery process, but also since there is no its accumulation or consumption, presence of this agent will not require any additional treatment.

In the back-recovery by back-extraction, similar recoveries as by new phase formation can be achieved, depending on the temperature, pressure, S/F ratio and the solvent used. For example, more polar solvent, like benzaldehyde or benzyl alcohol, compared with toluene, enables higher recovery. The maximum recovery by back-extraction is determined by a point of solvent saturation. If it is exceeded, a new phase - solid or liquid - will be formed and the recovery can not be characterised any more as back-extraction.

Nevertheless, the proposed combination of extraction using  $\text{NaHCO}_3$  and back-recovery by  $\text{CO}_2$  has certain limitations. Only acids stronger than carbon dioxide, i.e. carbonic acid, can be recovered in this way ( $\text{pK}_a < 6.4$ ). On the other hand, the back-recovery of acids much stronger than carbonic acid would require very high pressures and would still have low recoveries. Hence, there is a range of acid dissociation constants on which this approach can be applied. Furthermore, the solubility of carboxylate of the extracted acid in water is another limitation (as seen for decanoic acid). If it is too low, the acid can be extracted only partially, due to an eventual precipitation of the carboxylate during the extraction.

At the end, it should be mentioned that both the forward-extraction and the back-recovery, can be described with an acceptable accuracy by relatively simple mathematical models. Although, the model becomes more complex and requires more parameters if the salting-out agents are present in the system.

## Literature Cited

- (1) Perry, R. H.; Green, D. *Perry's chemical engineers' handbook*. McGraw-Hill: Singapore, 1984; pp. 15-4.
- (2) Ullmann, F. *Ullmann's Encyclopedia of Industrial Chemistry. Organic Chemicals. Xylenols. Separation*, 7th ed.; Wiley-Interscience: New York, 2003.
- (3) Kirk, R. E.; Othmer, D. F. *Kirk-Othmer Encyclopedia of Chemical Technology. Extraction, Liquid-Liquid. Principles*; Wiley-Interscience: New York, 2003.
- (4) Wadekar, V. V.; Sharma, M. M. Separation of low Boiling Organic Acids / Bases by Dissociation Extraction; Binary and Ternary Systems; Substituted Anilines; Binary System with Thermally Regenerative Extractant: Chlorophenols. *J. Separ. Proc. Technol.* **1981**, 2, 28-32.
- (5) Gaikar, V. G.; Sharma, M. M. Separation of Cumidines by Dissociation Extraction. *J. Sep. Proc. Technol.* **1984**, 5, 49-52.
- (6) Gaikar, V. G.; Sharma, M. M. Separation of Substituted Phenols and Chlorophenols by Dissociation Extraction; New Regenerative Method; New Strategies. *J. Sep. Proc. Technol.* **1984**, 5, 53-56.
- (7) Pai, R. A.; Doherty, M. F.; Malone, M. F. Design of reactive extraction systems for bioproduct recovery. *AIChE J.* **2002**, 48, 514-526.
- (8) Van Halsema, F. E. D.; Van der Wielen, L. A. M.; Luyben, K. Ch. A. M. The Modeling of Carbon Dioxide-Aided Extraction of Carboxylic Acids from Aqueous Solutions. *Ind. Eng. Chem. Res.* **1998**, 37, 748-758.
- (9) Sergeeva, V. F. Salting-out and Salting-In of Non-Electrolytes. *Russ. Chem. Rev.* **1965**, 34, 309-318.
- (10) Long, F. A.; McDevit, W. F. Activity Coefficients of Nonelectrolyte Solutes in Aqueous Salt Solutions. *Chem. Rev.* **1952**, 51, 119-160.
- (11) Höll, W. H.; Hagen, K. Municipal Drinking Water Treatment by the CARIX Ion Exchange Process. In *Ion Exchange Advances*, Proceedings of IEX'92, Cambridge, UK, July 12-17, 1992; Elsevier Applied Sciences: New York, 1992.
- (12) Zammouri, A.; Chanel, S.; Muhr, L.; Grevillot, G. Displacement Chromatography of Amino Acids by Carbon Dioxide Dissolved in Water. *Ind. Eng. Chem. Res.* **1999**, 38, 4860-4867.
- (13) Hofland, G. W.; Van Es, M.; Van der Wielen, L. A. M.; Witkamp, G. Isoelectric Precipitation of Casein Using High-Pressure CO<sub>2</sub>. *Ind. Eng. Chem. Res.* **1999**, 38, 4919-4927.
- (14) Urbas, B. Recovery of Organic Acids from a Fermentation Broth. U.S. Patent 4,444,881, 1984.
- (15) Miller, R. W.; Cockrem, M. C. M.; De Pablo, J. J.; Lightfoot, E. N. Extraction of Lactic Acid from a Calcium Lactate Solution Using Amine-Containing Solvents and Carbon Dioxide Gas. *Ind. Eng. Chem. Res.* **1996**, 35, 1156-1162.
- (16) Baniel, A. M.; Eyal, A. M.; Mizrahi, J.; Hazan, B.; Fisher, R. R.; Kolstad, J. J.; Stewart, B. F. Lactic Acid Production, Separation and/or Recovery Process. U.S. Patent 5,510,526, 1996.
- (17) Broekhuis, R. R.; Lynn, S.; King, C. J. Recovery of Propylene Glycol from Dilute Aqueous Solutions by Complexation with Organoborates in Ion-Pair Extractants. *Ind. Eng. Chem. Res.*, **1996**, 35, 1206-1214.
- (18) Phillips, J. B.; Nguyen, H.; John, V. T. Protein Recovery from Reversed Micellar Solutions through Contact with a Pressurized Gas Phase. *Biotechnol. Prog.* **1991**, 7, 43-48.
- (19) Gallagher, P. M.; Coffey, M. P.; Krukoni, V. J. Gas Anti-Solvent Recrystallization of RDX: Formation of Ultra-fine Particles of a Difficult-to-Comminute Explosive. *J. Supercrit. Fluids*, **1992**, 5, 130-142.

- 
- (20) Kulpe, J.; Strutz, H.; Ruffer, H.; Rittner, S. Process for Releasing Acidic Organic Compounds from Salts thereof by Carbon Dioxide. U.S. Patent 5,543,564, 1996.
- (21) Enke, C. G. *The Art and Science of Chemical Analysis*. John Wiley & Sons: New York, 2001.
- (22) Bart, H. *Reactive Extraction*; Springer-Verlag: Berlin, 2001; pp. 32-37
- (23) Pitzer, K.S. Ion Interaction Approach: Theory and Data Correlation. In *Activity Coefficients in Electrolyte Solutions*; Pitzer, K. S., Ed.; CRC Press: London, 1991.
- (24) Zemaitis, J. F. Jr.; Clarck, D. M.; Rafal, M.; Scrivner, N. C. *Handbook of Aqueous Electrolyte Thermodynamics: Theory & Applications*; American Institute of Chemical Engineers: New York, 1986.
- (25) Xia, J.; Rumpf, B.; Maurer, G. Solubility of Carbon Dioxide in Aqueous Solutions Containing Sodium Acetate or Ammonium Acetate At Temperatures from 313 to 433 K and Pressures up to 10 MPa. *Fluid Phase Equilibria* **1999**, *155*, 107-125.
- (26) Kirsch, T.; Ziegenfuß, H.; Maurer, G. Distribution of Citric, Acetic and Oxalic Acids Between Water and Organic Solutions of Tri-*n*-octylamine. *Fluid Phase Equilibria*. **1997**, *129*, 235-266.

## Chapter 5

# Reactive extraction of alcohols

### 5.1 Introduction

There is hardly any known application of reactive extraction in the recovery of alcohols, either from the organic or from the aqueous phase. Although certain amines and phosphoryl compounds are evaluated as extractants for the recovery of ethanol from an aqueous solution into an organic solvent,<sup>1,2</sup> these attempts did not result in a significantly greater distribution ratio than already provided by the conventional solvents. Some authors applied a reaction to enable extraction of diols, calling it the reactive extraction of diols.<sup>3,4</sup> However, this case is closer to physical than to reactive extraction, since it involves a reaction in which the diol is converted into a less polar component, which has a higher physical distribution ratio than the original compound, prior to and not during the extraction.

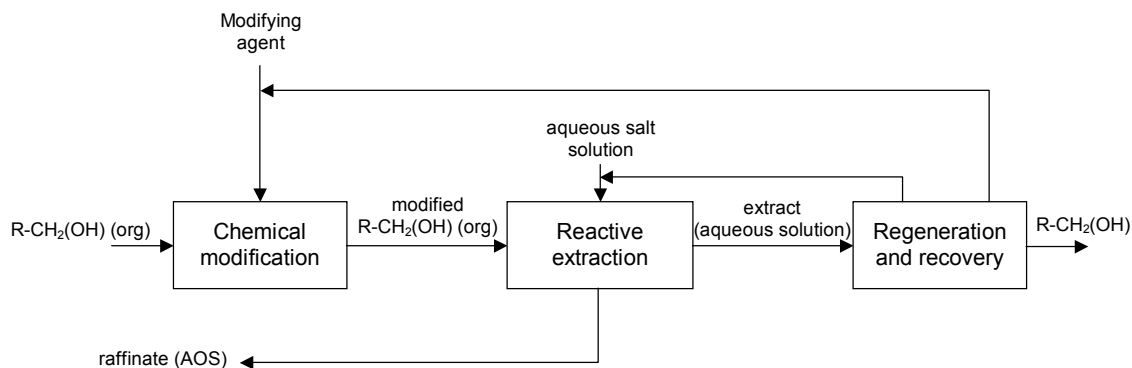
As already mentioned in Chapter 1, reactive extraction can provide a more efficient solution for the recovery of a product from a dilute solution than distillation or conventional extraction. Therefore, the possibilities of using reactive extraction will be explored for the recovery of alcohols. In this study the applicability of reactive extraction for the recovery of a low or moderately water-soluble monohydroxyl alcohol from a dilute apolar organic solution is evaluated.

Although water itself can provide fair values of the equilibrium distribution ratio for many of such alcohols, still a high solvent-to-feed ratio and/or a large number of equilibrium stages would be required to achieve a satisfactory recovery of an alcohol using water as extraction solvent. For example, for the distribution ratio of benzyl alcohol between water and toluene of around 0.3 at 25 °C (see Chapter 1), more than 35 transfer units with a solvent-to-feed ratio of 3.5 would be necessary to achieve 99% recovery. If this ratio would be increased by at least an order of magnitude, and preferably even higher, the extraction using a water-based solvent would become more attractive.

In order to improve the extraction capacity of water toward such alcohols, we consider the introduction of different compounds (mainly salts) in water, which could react reversibly with the hydroxyl group of a monohydroxyl alcohol, and act as reactive extractants.

However, due to structural similarities of water and alcohols, it can be expected that potential extractants which can react with a hydroxyl group of the alcohol, will also interact with water, and therefore will not significantly increase the distribution ratio of the alcohol.

Therefore, in parallel with the above-mentioned approach, another option, in which the alcohol is first modified into another, easy-extractable specie, and subsequently exposed to reactive extraction, is also evaluated. The operations involved in the alcohol recovery by such reactive extraction are schematically shown in Figure 5.1. In the further text this approach is called reactive extraction of modified alcohol, whereas the former case is referred to as reactive extraction of unmodified alcohol.



**Figure 5.1** Reactive extraction of an alcohol from an apolar organic solvent (AOS) into an aqueous salt solution preceded by a chemical modification of the alcohol, i.e. reactive extraction of modified alcohol.

Benzyl alcohol in toluene is used as a representative case of a moderately-water soluble monohydroxyl alcohol dissolved in an apolar organic solvent. The options which show satisfying results for that case - providing a distribution ratio of at least an order of magnitude higher than the physical distribution ratio provided by pure water - will also be evaluated for the extraction of cyclohexanol from cyclohexane and of 1-hexanol from n-hexane. In that way, the applicability to cycloaliphatic and linear aliphatic alcohols, besides aromatic ones, will also be explored.

## 5.2 Reactive extraction of unmodified alcohol

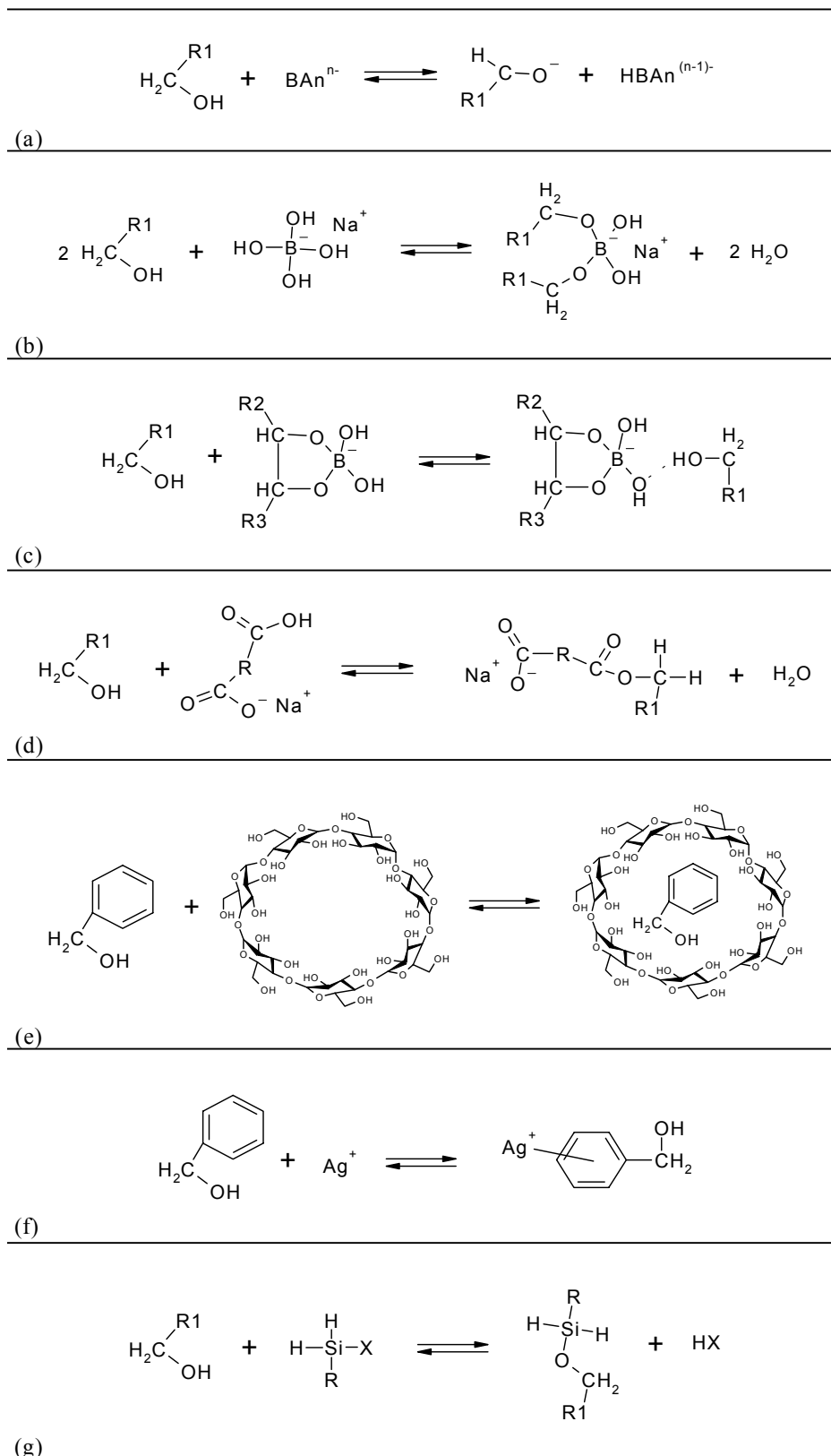
Different reversible chemical reactions are considered and most of them are also experimentally evaluated for use in the reactive extraction of alcohols. As already discussed in Chapter 1, to assure no solubility in the organic phase, the essential selection criterion for selecting suitable reactions is that both, the reactant and the reaction product, are charged, or at are least highly water soluble species. All considered options are shown in Figure 5.2, and the details and characteristics of each of these reactions are discussed below.

Although it will be further discussed latter, it should be emphasised here that the complexation with a transition metal ion is limited to the recovery of an aromatic alcohol, whereas the applicability of the complexation with a cyclodextrin differs for different alcohols.

### 5.2.1 Dissociation reaction

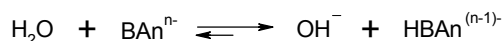
Although they are weak acids, alcohols exhibit certain acidic properties.<sup>5,6,7</sup> Therefore, the presence of an adequate alkali salt in water could cause the dissociation and generation of an alkoxide ion (see Figure 5.2a), which, as a charged compound, would be much more soluble in the aqueous phase.





**Figure 5.2** Interactions considered for the reactive extraction of alcohols into an aqueous solvent: (a) dissociation reaction, (b) reaction with borate, (c) complexation with borate-diol complex, (d) esterification with monosalt of a dicarboxylic acid, (e) complexation with cyclodextrines, (f) complexation with transition metal ion, (f) etherification with halosilanes (or halohydrocarbons, if Si is replaced by C).

However, the dissociation constants of alcohols are very close to that of water. For example, for methanol, propanol and benzyl alcohol the pK<sub>a</sub> values are 15.5, 16.5 and 15.4, respectively, whereas the value for water is 15.7 (at room temperature).<sup>8</sup> This means that even if such a basic salt is found, a competition of water and the alcohol to protonate the salt would occur (see also Scheme 5.1). Since water is present in a much higher concentration, the equilibrium of reaction 5.1a would not be shifted much to the right, i.e. not much alkoxide would be generated.



**Scheme 5.1** Dissociation of water caused by a basic salt anion (BAn<sup>n-</sup>).

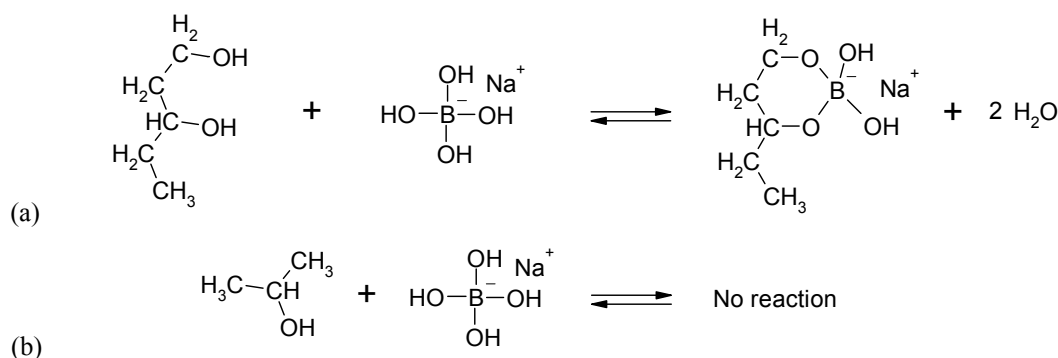
Hence, it is concluded that the dissociation of an alcohol in an aqueous medium would not be feasible. Therefore, this reaction will not be experimentally evaluated.

### 5.2.2 Reaction with borate

It is known that diols and polyols form reversible complexes with borate salts. Some examples are the cross-linking of poly(vinyl alcohol) by a borate during the production of a multipurpose gel,<sup>9,10,11</sup> quantitative chromatographic analysis of polyhydroxyflavones (which contain several hydroxyl groups) in which these compounds complex with a borate on the column packing,<sup>12</sup> and separation of a mixture of racemic amino-alcohols by extraction into an organic phase due to the formation of a selective borate-amino alcohol complex.<sup>13</sup>

Since the formed complex is a charged compound and the reaction is reversible, it would be potentially suitable for the reactive extraction of an alcohol. However, the applicability on a monohydroxyl alcohol is not reported in the literature and therefore it is questionable.

The mechanism of this complexation has been analysed by many authors.<sup>14,15,16,17,18</sup> It has been suggested that di- and polyhydroxyl aliphatic alcohols, having the structure of a 1,3-diol, complex with borate, whereas monohydroxyl aliphatic alcohols do not (see Scheme 5.2).<sup>17</sup>

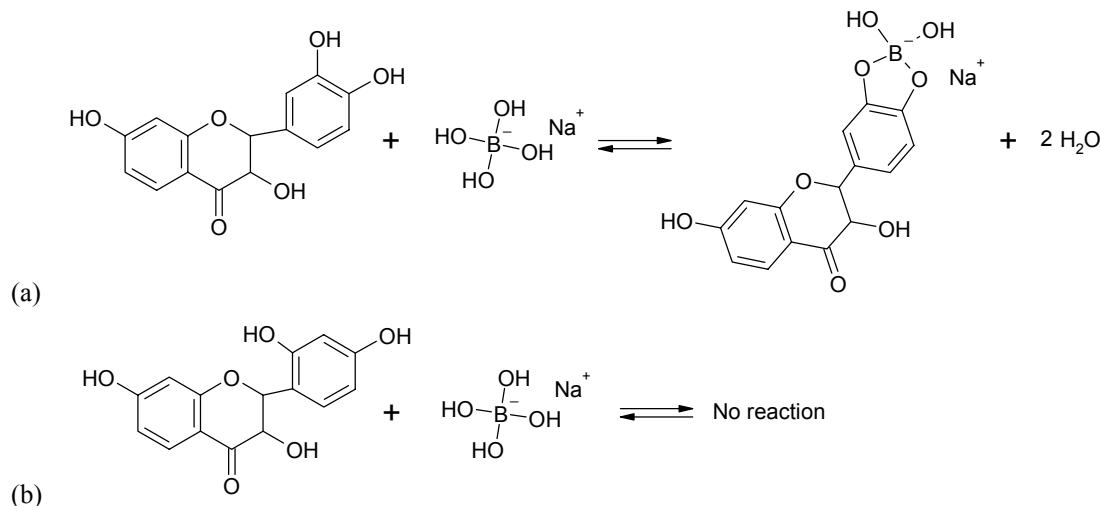


**Scheme 5.2** Reaction of sodium borate (a) pentanediol and (b) no reaction with 2-propanol.<sup>17</sup>

Furthermore, among different polyhydroxyflavones (aromatic polyols) a significant difference in complexation behaviour between those having a 1,2-diol and 1,3-diol structure is noticed. Those with a 1,2-diol structure show complexation, whereas the others do not complex (see Scheme 5.3).<sup>12</sup>

It is obvious that borates interact with OH groups. However, the reaction occurs only if a molecule has more than one OH group and if two of those are located at an adequate distance from each other that they can participate simultaneously in the reaction.

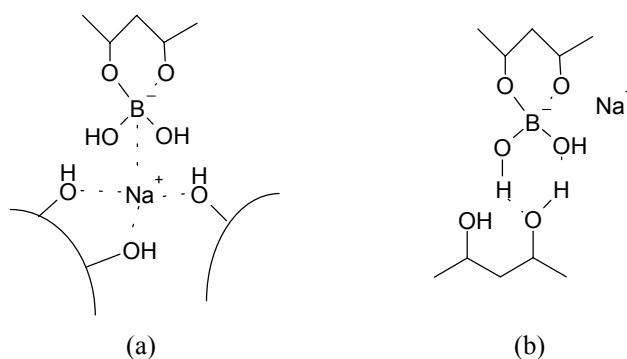
Although these findings decrease the possibility of complexation of a monohydroxyl alcohol with a borate, it is worthwhile to try if two molecules of a larger monohydroxyl alcohol, such as benzyl alcohol, can provide the two OH groups at the right distance to form a complex with the borate. Therefore, this reaction is selected to be evaluated experimentally. Sodium borate is used to represent the borate salts.



**Scheme 5.3** Interaction of polyhydroxyflavones having OH groups (a) in 1,2 and (b) in 1,3 positions with sodium borate.<sup>12</sup>

### 5.2.3 Complexation with borate-diol complex

Another option involving borates is a potential complexation of a monohydroxyl alcohol with a borate-diol complex. According to the proposed mechanism of crosslinking in poly(vinyl alcohol),<sup>17</sup> it can be assumed that the borate-diol complex may interact with the alcohol either through its ionic bond or by hydrogen bonding. Both of these interactions seem to occur, but the interaction via the ionic bond is found dominant (see Scheme 5.4).



**Scheme 5.4** Suggested complexation of borate-diol complex with hydroxyl compounds by (a) interaction of its ionic bond with OH groups of diol or (b) hydrogen bonding.<sup>17</sup>

Again, a charged compound would be generated and, since the bonds are not strong, decomplexation would be easy. However, it has to be evaluated if these interactions are sufficient for the desired extraction purpose, where the alcohol is present in low concentrations and water may interact in the same way with borate. Therefore, the potential complexation of benzyl alcohol with a borate-diol complex is also experimentally investigated. The borate complex formed with 1,2-propanediol is used for this purpose.

### 5.2.4 Esterification with dicarboxylic acid monosalt

Esterification is one of the most characteristic reactions of alcohols.<sup>6</sup> Generally, a carboxylic acid reacts with an alcohol, producing an ester and water. The reaction is acid catalysed. Many examples of the use of esterification for separation purposes can be found in the literature. For example, ethanol is recovered from an aqueous solution by a membrane process applying esterification by caprylic, heptanoic or octanoic acid.<sup>19</sup> To apply this reaction for the reactive extraction of alcohols from the organic phase, both the acidic reactant, but also the ester, should be charged. Therefore, the option in which a monosalt of a dicarboxylic acid is used as the esterification agent is considered (see Figure 5.2d). This compound is not only a salt, but also has a carboxylic group able to esterify the alcohol, yielding an ester which is then also charged. However, the possibility of performing this reaction in an aqueous medium may be a problem due to the generation of water whereas generally the reaction equilibrium constants of esterification reactions are not too high.

The applicability of a monosalt of dicarboxylic acid for the reactive extraction of an alcohol is explored by employing monosodium maleate on the extraction of benzyl alcohol. This salt is chosen due to its good solubility in water (at room temperature, around 55 g/l) and because it is commercially available.

### 5.2.5 Complexation with cyclodextrins

Although no salts, cyclodextrins may also be used for the purpose investigated in this study. The external surface of these cyclic, cone-shaped oligomers of  $\alpha$ -D-glucopyranose units, is hydrophilic, while the cavity is hydrophobic (see Figure 5.3). This enables the dissolution of a hydrophobic molecule in water by its inclusion in the cyclodextrin cavity. A disadvantage of the naturally occurring cyclodextrins ( $\alpha$ ,  $\beta$  and  $\gamma$ ) for potential use is their low solubility in water, which is not higher than 18 mmol/l.<sup>20</sup> It can be expected that the formed complex also has such a low solubility. However, by substituting the hydroxyl groups on the cavity rims, cyclodextrin derivatives like hydroxypropylated, methylated, carboxymethylated, sulphated, etc. with a much higher solubility in water can be obtained. For example, at a certain degree of substitution, the solubility of hydroxypropyl- $\beta$ -cyclodextrin can go up to 75 wt%,<sup>21</sup> whereas at least 33 wt% of hydroxypropyl- $\alpha$ -cyclodextrin,<sup>22</sup> and 35 wt% of sulphated- $\beta$ -cyclodextrin,<sup>23</sup> can be dissolved in water. On the other side, the solubility of these substituted cyclodextrins in the apolar organic solvent is very low. Therefore, by forming an inclusion complex with such cyclodextrins, low-water soluble alcohols potentially can be extracted into the aqueous phase.

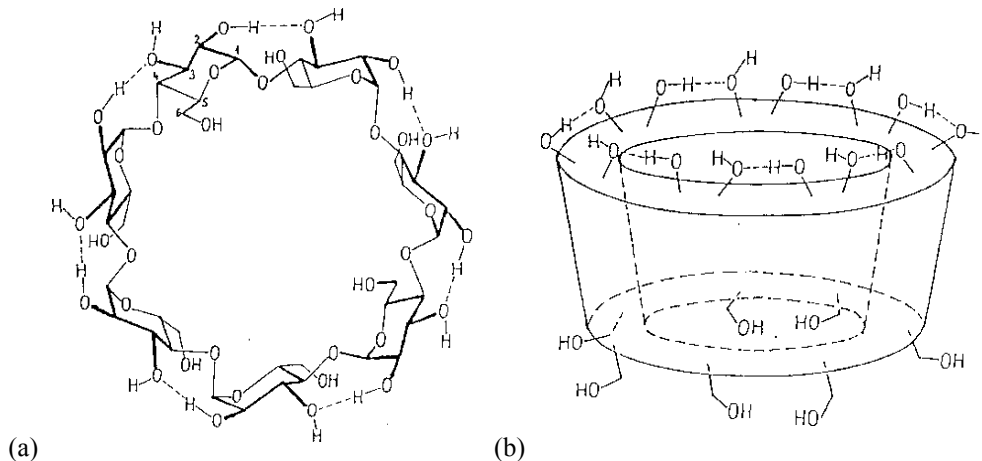


Figure 5.3 (a) Top-view and (b) side-view of a  $\beta$ -cyclodextrin.

Based on geometry, a molecule with the size of toluene or benzyl alcohol fits the best in the cavity of  $\beta$ -cyclodextrins. This can be confirmed by the highest values of the complexation constants with toluene for  $\beta$ - compared to  $\alpha$ - and  $\gamma$ -cyclodextrins.<sup>24</sup> This suggests that a  $\beta$ -cyclodextrin can be used for the purpose of this investigation. In that case the complexation constant for the interaction with benzyl alcohol should be higher than with toluene in order to achieve a satisfying selectivity. Although values of the complexation constant for the complexation of cyclodextrins with benzyl alcohol have been reported by different authors,<sup>25,26,27</sup> those values differ a lot. Therefore, it is difficult to draw an a priori conclusion whether the alcohol will really complex better with  $\beta$ -cyclodextrin than toluene.

Concerning the  $\alpha$ -cyclodextrins, although the size of the cavity does not enable inclusion complexation of toluene, it is still reported that a toluene-size molecule, but with an aromatic hydroxyl group (such as phenol), has a significantly higher complexation constant than toluene itself.<sup>28</sup> It is suggested that such a hydroxyl group penetrates into the cavity and forms hydrogen bonds with the hydroxyl groups on the rim.<sup>29,30</sup> Although benzyl alcohol does not have an aromatic OH group, still its hydroxyl group could make a difference and enable a complex formation with an  $\alpha$ -cyclodextrin.

Therefore, a hydroxypropyl- $\alpha$ -cyclodextrin, with an average molar substitution (AMS) of 0.6, and two hydroxypropyl- $\beta$ -cyclodextrins with different degree of substitution (0.6 and 1.0) are experimental evaluated. To emphasise again, the chosen cyclodextrins are intended for the complexation with benzyl alcohol and therefore an eventual complexation with another alcohol may lead to the selection of a different cyclodextrin.

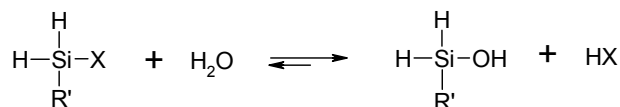
### 5.2.6 Complexation with transition metal ion

The transition metal ions are known for their reversible  $\pi$ -complexation with unsaturated and aromatic hydrocarbons.<sup>31,32</sup> With aromatic compounds, the metal cation creates  $\pi$ -bonds with the benzene ring forming a complex.<sup>32</sup> This characteristic can be exploited for the extraction of aromatic alcohols. Although this complex can be generally formed with any aromatic ring, the complexation constant differs for various aromatics. For example, the complexation constant of toluene is 20% higher than that of benzene at room temperature.<sup>33</sup> Furthermore, the solubility of benzyl alcohol in water is much higher than the solubility of toluene and therefore the complexation with an alcohol could be much more pronounced relative to the apolar organic solvent. Hence, it may be worth to explore the potential application of transition metal salts as extraction agents for the recovery of benzyl alcohol from toluene. Silver nitrate is chosen to represent this type of extractants.

### 5.2.7 Etherification with halosilane or halohydrocarbon

Etherification with halosilanes or halohydrocarbons is another characteristic reaction of alcohols. It is reversible and it could be performed with a charged reactant to gain a charged product. In that case the hydrocarbon tail R in the scheme shown in Figure 5.2g has to be charged.

However, both halosilanes and halohydrocarbons are very sensitive to the presence of water, even in traces. They react with water thereby losing the capability to react with an alcohol (see Scheme 5.5).



**Scheme 5.5** Halosilanes and halohydrocarbons consumed by water.

Hence, having a halosilane or a halohydrocarbon in an aqueous solution is unfeasible and therefore this option is rejected without any experimental evaluation.

### 5.3 Reactive extraction of modified alcohol

The conversion of an alcohol into another compound in order to enable or improve its separation is not new and various examples can be found in the literature.<sup>3,4,34</sup> However, they are limited to distillative recovery of monohydroxyl alcohols or extraction of polyols, and no examples of the apriori modification of a monohydroxyl alcohol for extraction purposes are reported. For example, an alcohol is converted into a ketone to allow the separation of a ketone, originally present in the solution, and the alcohol, by distillation.<sup>34</sup> Direct extraction of propylene glycol or 1,3-propanediol from dilute aqueous solutions into an apolar organic solvent exhibits very low distribution ratios. However, if converted into a dioxane by an acid-catalysed reaction with acetaldehyde or formaldehyde, prior to extraction, the distribution ratio become much higher and extraction becomes a very attractive option for their removal from dilute aqueous solutions.<sup>3,4</sup>

In order to apply this approach on the extraction of an alcohol from an apolar organic solvent, the following criteria have to be satisfied:

- the modification has to result in a compound that can be easily (and selectively) extracted into the aqueous phase,
- the modification reaction has to be attainable in the apolar organic solvent and must be reversible in order to regenerate the alcohol after extraction,
- the modifying agent should not cause any contamination nor has any undesirable effect on the other products in the organic phase, and finally
- the agent should be easily regenerated after separation, to be reused.

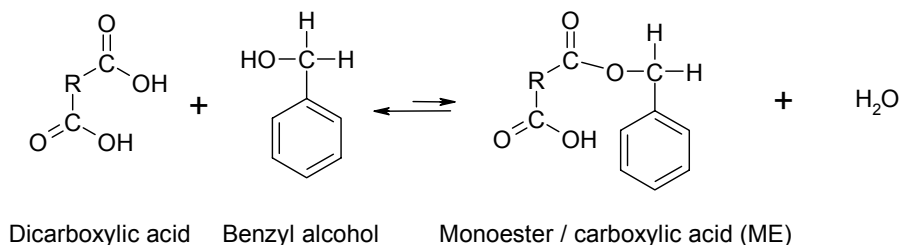
To fulfil the first criterion, the fact that carboxylic acids can be efficiently extracted into alkali aqueous solutions, initiated the consideration of an alcohol modification into a carboxylic acid. The dissociation extraction of acids is already discussed in Chapter 4 where it was shown that very high distribution ratios (up to several hundreds) can be achieved for different acids, even by using environmentally benign solvents like an aqueous solution of sodium hydrogen carbonate. Therefore, modification of the alcohol into an acid is selected as a way to improve its extractability. Alternative modifications into other compounds may be possible, but modification into an acid is found to be the most promising. The feasibility of such option to fulfil the remaining criteria is analysed in the following paragraphs.

#### 5.3.1 Modification by monoesterification with cyclic anhydride

Although different reactions may be considered in order to modify an alcohol into a carboxylic acid, we have chosen to evaluate esterification as one of the most characteristic reversible reactions of alcohols. Partial esterification of a dicarboxylic acid or a cyclic anhydride, so called monoesterification, would convert an alcohol into a monoester, which is in the same time a carboxylic acid (see Schemes 5.6 and 5.7).

However, several disadvantages of monoesterification with dicarboxylic acids exist. The reaction equilibrium constants of this reaction are generally low, i.e. a significant excess of dicarboxylic acid is necessary to achieve a satisfying conversion of the alcohol into a monoester, even if water is removed from the reaction medium. In combination with the fact that di- and polycarboxylic acids are very poorly soluble in apolar organic solvents,<sup>35</sup> only

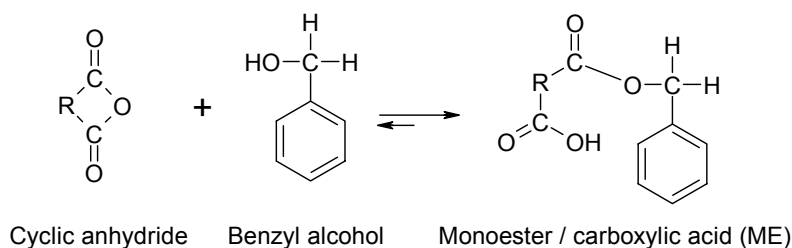
low conversions could be achieved. In addition, the reaction is very slow if not catalysed, and if catalysed, the formation of undesired diester is becoming significant. Once a diester is formed, i.e. if a second alcohol molecule is attached to the monoester, the centre for dissociation (COOH group) is lost and such a modified alcohol could not be extracted into water any more. Therefore, monoesterification with dicarboxylic acids does not seem to be a feasible option for use in reactive extraction of alcohols.



**Scheme 5.6** Monoesterification of benzyl alcohol by a dicarboxylic acid.

On the other hand, monoesterification with cyclic anhydrides is an equilibrium reaction in which the generation of monoester is more favoured. Furthermore, although different from one to another, the solubility of anhydrides in apolar organic solvents is much higher compared to dicarboxylic acids, enabling high conversions of the alcohol into a monoester. For example, reactions with phthalic and mellitic anhydrides are the basis of an analytical method for quantification of the concentration of hydroxyl groups in solution due to the quantitative conversion of the alcohol into a monoester.<sup>36</sup>

It should be emphasised that use of an anhydride of a monocarboxylic acid, instead of cyclic anhydride, would generate an ester with no dissociation centre, i.e. a component which can not be extracted by dissociation extraction. Therefore, anhydrides of monocarboxylic acids are not applicable for the evaluated purpose.



**Scheme 5.7** Monoesterification of benzyl alcohol by a cyclic anhydride.

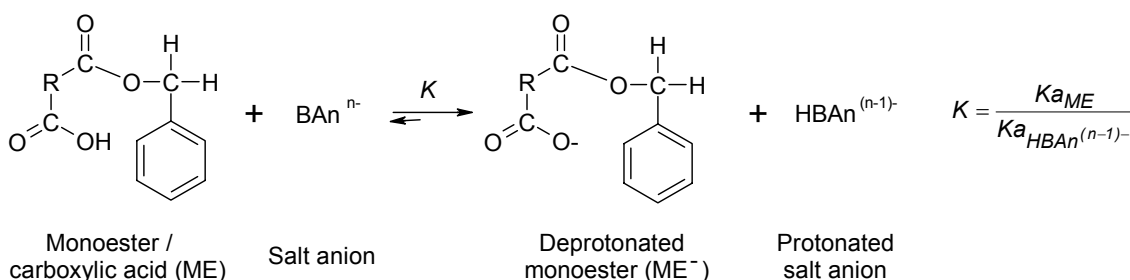
Although there are many examples of catalysed monoesterifications with cyclic anhydrides [by catalysts like pyridine,<sup>36,37</sup> 4-(N,N-dimethylamino)pyridine, cobalt(II) chloride or TaCl<sub>5</sub>-SiO<sub>2</sub>,<sup>38</sup> different tertiary amines,<sup>39</sup> BF<sub>3</sub>, AlCl<sub>3</sub> or FeCl<sub>3</sub><sup>40</sup>], still many authors suggest that the use of a catalyst is not required to complete the reaction within a reasonable time. Avoiding a catalyst does not only prevent possible contamination of the solvent, but also formation of a diester. Monoesterification of different aliphatic alcohols with phthalic anhydride,<sup>41,42,43,44,45</sup> with maleic anhydride<sup>46</sup> or with hexahydrophthalic anhydride,<sup>47</sup> is observed to be reasonably fast without any catalyst. There are even reports of performing an acceptably fast non-catalysed monoesterification of benzyl alcohol in toluene, what is exactly the aim of this study.<sup>48,49</sup>

Therefore, cyclic anhydrides are adopted to be experimentally evaluated as modification agents of alcohols. Three cyclic anhydrides are chosen (see Section 5.3.5) for experimental

evaluation of the monoesterification of benzyl alcohol in toluene. The anhydride which shows the best performance will also be evaluated for the monoesterification of cyclohexanol in cyclohexane and of 1-hexanol in 1-hexane.

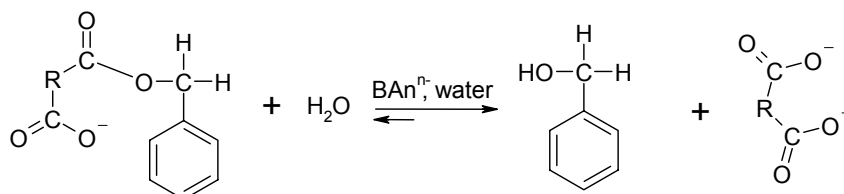
### 5.3.2 Dissociation extraction of modified alcohol

The formed monoester, i.e. the modified alcohol, still has one carboxylic group available which will dissociate in the presence of a basic salt, producing a charged and therefore more water-soluble carboxylate (see Scheme 5.8). The higher the value of the equilibrium constant  $K$  of this reaction, which is determined by the dissociation constants  $K_a$  of the generated acid and the monoester, the more monoester is extracted in the aqueous phase.



**Scheme 5.8** Dissociation of a monoester of benzyl alcohol by a basic salt.

However, once extracted into the aqueous phase, the monoester, either protonated (ME) or deprotonated (ME<sup>-</sup>), starts to hydrolyse (see Scheme 5.9). During the hydrolysis the alcohol is regenerated and it distributes between the two phases according to its physical distribution ratio ( $K_{D_{\text{BAIc}}}$ ). Hydrolysis is an ideal option for regeneration of the alcohol since it is occurring spontaneously in the aqueous solution, and in that sense it is a desired phenomenon. However, during extraction it also causes a loss of the already extracted alcohol.



**Scheme 5.9** Hydrolysis of a deprotonated benzyl alcohol monoester in aqueous salt solution [the generated carboxylic group is deprotonated due to the presence of the basic salt anion  $\text{BAn}^{n-}$ ].

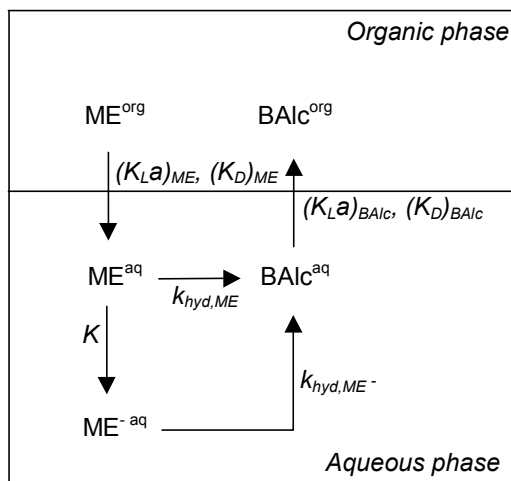
These phenomena occurring during the modified alcohol extraction are schematically illustrated in Figure 5.4. To keep the scheme simple, only the flow of the alcohol is indicated, whereas the other components are not included.

The overall distribution ratio of benzyl alcohol  $D_{\text{BAIc}}$ , is in this case defined as:

$$D_{\text{BAIc}} = \frac{c_{\text{ME}}^a + c_{\text{ME}^-}^a + c_{\text{BAIc}}^a}{c_{\text{ME}}^o + c_{\text{BAIc}}^o} \quad (5-1)$$

and is, unlike in the other cases in this thesis, not considered at equilibrium, but monitored as a time dependent value. The reason is that a maximum value of the distribution ratio is obtained not at equilibrium, but before the equilibrium is reached.





**Figure 5.4** Schematic representation of the flow of alcohol (unmodified and modified) during extraction:  $ME^{org}$  and  $ME^{aq}$ , monoester in the organic and aqueous phase;  $ME^{-aq}$ , deprotonated monoester in the aqueous phase;  $BAIC^{org}$  and  $BAIC^{aq}$ , benzyl alcohol in the organic and aqueous phase, respectively.

As can be seen in Figure 5.4, the overall distribution ratio is a function of the following parameters:

- dissociation equilibrium constant  $K$  (see Scheme 5.8),
- monoester hydrolysis rate constants  $k_{hyd,ME}$  and  $k_{hyd,ME^-}$  (at high values of  $K$ , which are aimed for, mainly  $ME^-$  and no  $ME$  is present, and therefore  $k_{hyd,ME^-}$  has more important role),
- overall volumetric mass transfer coefficient of the monoester  $(K_L a)_{ME}$ ,
- physical distribution ratio of monoester between aqueous and organic phases  $(K_D)_{ME}$ ,
- overall volumetric mass transfer coefficient of benzyl alcohol  $(K_L a)_{BAIC}$ , and
- physical distribution ratio of benzyl alcohol between aqueous and organic phase  $(K_D)_{BAIC}$ .

Although the rate constant of the monoester dissociation reaction should also be included, this reaction is considered as instantaneous and at each moment at equilibrium. Therefore it is characterised only by the dissociation equilibrium constant  $K$ .

The dissociation equilibrium constant  $K$  and the hydrolysis rate constant  $k_{hyd,ME^-}$  are the parameters which depend on the used extractant (salt), whereas the other parameters are almost independent on the type of salt.  $K$  is directly influenced (see Scheme 5.8), whereas  $k_{hyd,ME^-}$  is function of the pH of the solution as the rate of hydrolysis significantly increases with increasing pH.<sup>50</sup> If a salt which enables a high value of  $K$  and does not create to basic aqueous solution is found, high overall distribution ratios for the modified alcohol modified alcohol could be achieved and that would confirm that proposed extraction technique is feasible. Optimisation of mass transfer conditions can be done later. Therefore, only the effect of the type of salt and its concentration in the aqueous phase on the overall distribution ratio is investigated in this study, whereas the mixing conditions are kept equal in all cases.

The salt that is adequate for this purpose has to be selected based on the dissociation constant of the monoester  $K_{a,ME}$ , which, although not listed in standard databases, can be taken as equal to the second dissociation constant of the adequate dicarboxylic acid.<sup>39,51</sup> The conjugated acid of the salt needs to have a dissociation constant lower than that of the monoester in order to get a reasonably high value of  $K$  and to cause deprotonation of the monoester.

If a salt like hydrogen carbonate could be applied ( $\text{BAn}^{\text{n-}}$  is  $\text{HCO}_3^-$  in Scheme 5.8), several advantages could be exploited. First, just a mildly basic solution ( $\text{pH} \approx 9$ ) will be operated with, not requiring any special safety precautions or equipment requirements. Secondly, the dissociation product is carbonic acid ( $\text{H}_2\text{CO}_3$ ), i.e. carbon dioxide, which does not need any special treatment to be removed from the aqueous phase after the extraction is completed. Finally, the possibility to use  $\text{CO}_2$  under pressure, as evaluated in Chapter 4, for eventual removal of the deprotonated dicarboxylic acids from the aqueous phase (see Scheme 5.9) is open.

A 0.1 M solution of monobenzyl phthalate in toluene is used to represent the diluted organic solution of the modified benzyl alcohol. This monoester is selected since it is the only commercially available monoester of benzyl alcohol, 1-hexanol or cyclohexanol that is generated in the monoesterification reactions evaluated in this study. Besides the aqueous solution of sodium hydrogen carbonate, which is, as already mentioned, the preferable extraction solvent, a solution of sodium hydroxide is also evaluated. It is a stronger base than  $\text{NaHCO}_3$  and can give insight in the extraction at high pH. For both solutions two extreme cases are considered. First, when the extractant is present in a large excess relative to the alcohol (2 M NaOH solution and 1 M for  $\text{NaHCO}_3$  solution, at an aqueous-to-organic volume ratio of 1), and the other, when the ratio of the number of moles of the salt and benzyl alcohol is 1.

### 5.3.3 Regeneration and back-recovery of extracted alcohol

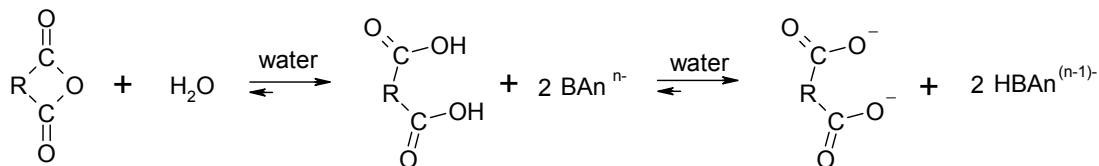
After extraction and separation of the two phases, the alcohol has to be regenerated from the monoester and recovered from the aqueous phase. As already mentioned in Section 5.3.2, this regeneration does not need any special treatment since the monoester spontaneously hydrolyses in the aqueous solution and releases the alcohol (see Scheme 5.9). A slow hydrolysis is desired for the extraction, but for the regeneration step the opposite is true. As the time for hydrolysis is longer, larger process equipment will be necessary. In order to increase the rate of hydrolysis during the regeneration, a pH shift<sup>50,52</sup> and/or temperature shift,<sup>53</sup> but also alternative methods like ultrasonic acceleration<sup>54</sup> or biodegradation<sup>55</sup> could be employed. Since a pH shift requires the introduction of an additional chemical that needs to be removed afterwards, a temperature shift is preferable. The regenerated alcohol could be back-extracted into a high-molecular-weight apolar organic solvent and then distilled or, if it is poorly soluble in water, simply separated from the aqueous phase by decantation of the newly formed alcohol phase.

To evaluate the feasibility of a temperature controlled regeneration by hydrolysis, the extraction of monobenzyl phthalate into an aqueous salt solution is evaluated as a function of temperature. The effect of temperature on the rate of hydrolysis can be characterised by determining the concentration of benzyl alcohol in the organic phase as a function of time. For this analysis, the salt ( $\text{NaHCO}_3$  or  $\text{NaOH}$ ) solution which shows the best performance during the evaluation of the extraction capabilities will be applied.

### 5.3.4 Regeneration and back-recovery of cyclic anhydride

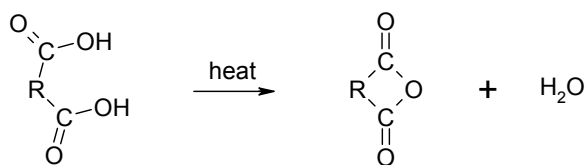
The other product of the monoester hydrolysis is the deprotonated dicarboxylic acid (see Scheme 5.9). Furthermore, if an excess of anhydride is used in the modification reaction, it will also be extracted into the aqueous phase as deprotonated dicarboxylic acid. As it comes in contact with water it hydrolyses into dicarboxylic acid, which is then deprotonated by the extraction salt (see Scheme 5.10). If the salt is able to extract the monoester in Scheme 5.8,

then both carboxylic groups of the formed dicarboxylic acid will dissociate in the presence of such a salt, as shown in Scheme 5.10, because the pKa of the monoester is, as already mentioned in Section 5.3.2, equal to the pKa<sub>2</sub> of the dicarboxylic acid. That means that as pKa<sub>1</sub> is lower than pKa<sub>2</sub>, and since the group with pKa<sub>2</sub> is deprotonated, the same will happen with the other.



**Scheme 5.10** Hydrolysis of excess cyclic anhydride and deprotonation by extraction salt (salt's anion  $\text{BAn}^{n-}$  is basic enough to cause deprotonation of both carboxylic groups).

In order to be reused in the process, this acid has to be converted back to cyclic anhydride. Although many methods for dehydration of a dicarboxylic acid exist (by help of acetic anhydride, trifluoroacetic anhydride or ethoxyacetylene),<sup>56</sup> the simplest approach is conversion by heating (see Scheme 5.11). However, this option works only for cyclic anhydrides that contain five, six or seven atoms in the ring, and not less.<sup>38</sup>



**Scheme 5.11** Regeneration of cyclic anhydride from dicarboxylic acid by heat.

However, to be able to perform the described dehydration, the acid has to be protonated and removed from the aqueous medium. For protonation, the aqueous solution has to be acidified. The option which involves  $\text{CO}_2$  under pressure, already discussed in detail in Chapter 4 for the regeneration of extracted acids, is suitable for this case as well. Again, no new chemicals are involved or generated besides  $\text{NaHCO}_3$ , which is preferably already used as the extractant. Once protonated, the acid can be removed from water by a new phase formation, in the same way as evaluated for benzoic and hexanoic acids (see Chapter 4.1). Of course, this option requires that the acid has a low water solubility. The back-extraction in an apolar organic solvent, which is an alternative for new phase formation, is not an option in this case, since the solubility of dicarboxylic acids in apolar organic solvents is, as already mentioned, very low. Hence, if a  $\text{CO}_2$  based regeneration is the desired option, then the low water solubility of the acid has also to be kept in mind when selecting the adequate cyclic anhydride.

### 5.3.5 Selection of cyclic anhydrides

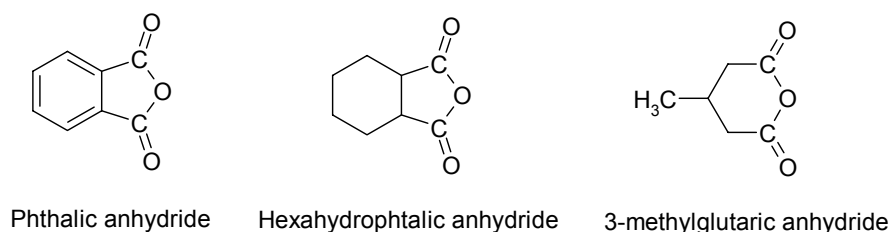
In the previous sections (5.3.1 - 5.3.4) all criteria are introduced that a cyclic anhydride has to fulfil to be used in the reactive extraction of alcohols:

1. it should be well soluble in apolar organic solvents of interest,
2. it should enable a high and fast conversion of the alcohol into a monoester,
3. the second dissociation constant of its dicarboxylic acid should preferably be lower than the dissociation constant of the carbonic acid ( $\text{H}_2\text{CO}_3$ ),
4. the rate of hydrolysis of its monoesters should be strongly influenced by temperature,

5. it should have a ring which contains five, six or seven atoms, and
6. its dicarboxylic acid should have a low water solubility.

Criteria 1, 3, 5 and 6 are used for the preliminary selection of the anhydrides. Those selected have to be experimentally evaluated to see whether the second and fourth criteria can also be fulfilled.

Solubility data of anhydrides in apolar organic solvents are very limited in the literature, where only qualitative indications of the solubility in benzene can be found.<sup>35</sup> In order to select anhydrides with a good solubility, the thermodynamic criterion is applied that if solutes are chemically similar, the one with the lower melting point has a higher solubility.<sup>57</sup> Therefore, commercially available cyclic anhydrides, with five-, six- or seven-atom rings, are sorted by their melting points. Furthermore, second dissociation constants of the adequate dicarboxylic acids are found in the literature.<sup>58,59</sup> Based on these, but also considering the safety, toxicity and cost information, three anhydrides are chosen for experimental evaluation: phthalic, hexahydrophthalic and 3-methylglutaric anhydride (see Figure 5.5).



**Figure 5.5** Selected cyclic anhydrides.

Hexahydrophthalic anhydride has a relatively low melting point of 29 °C whereas the  $pK_{a2}$  of hexahydrophthalic acid is 6.76. Although this  $pK_{a2}$  is higher than that of carbonic acid, denying the possibility to extract monoester of this anhydride using sodium hydrogen carbonate, it is still selected as a representative of highly soluble anhydrides.

In contrast, phthalic anhydride has an adequate  $pK_{a2}$  (5.40), but a rather high melting point of 131 °C. Nevertheless, although a poor solubility may be expected, it is still included in this evaluation as one of the most produced and cheapest cyclic anhydrides. Furthermore, the benzyl alcohol monoester of this anhydride is used as a model compound for evaluation of extraction of a modified alcohol (see Section 4.3.2), and hence, it is logical to include this anhydride in the evaluation of the alcohol modification as well.

The third, 3-methylglutaric anhydride melts at 40 °C and has a  $pK_{a2}$  of 5.44, providing an optimum between good solubility and low  $pK_{a2}$ .

Finally, the water solubilities of phthalic and hexahydrophthalic acids are low (only qualitative information available),<sup>35</sup> indicating a possibility to apply a  $CO_2$ -aided recovery of dicarboxylic acid from water. On the other hand, no reports on the solubility of 3-methylglutaric acid are found and hence, it must be evaluated prior to an eventual application of this anhydride.

### 5.3.6 Effects of implementation of alcohol modification in oxidation process

In Chapter 1 it is shown that hydrocarbon oxidation processes are suitable processes on which the reactive extraction analysed in this thesis can be applied. Hence, the effect of the alcohol modification on these processes is also discussed here.

In addition to the possibility to recover the alcohol from the hydrocarbon oxidation reaction mixture, this chemical modification may also provide a tool to increase the selectivity toward alcohol, without the need for low conversions of the apolar hydrocarbon in the reactor. If a cyclic anhydride is introduced in the reactor during the oxidation, it could in-situ convert the generated alcohol in a monoester thereby preventing its further oxidation. By controlling the amount of generated monoester, the ratio of oxidation products can still be maintained at the required value, allowing an increase in the conversion of the apolar hydrocarbon. Examples of such in-situ conversion of the alcohol in the oxidation reactor are also reported in the literature. Acetic anhydride is introduced in the toluene oxidation reactor to convert benzyl alcohol into benzyl acetate to protect the hydroxyl group from further oxidation, in order to control the production rate of the alcohol.<sup>49</sup> Regeneration of alcohol is done by hydrolysis after separating the ester in a distillation tray. Similar approaches, but by adding acetic acid or acid chlorides instead of acetic anhydride are reported elsewhere.<sup>60,61</sup>

## 5.4 Experimental section

### 5.4.1 Chemicals

Benzyl alcohol (purity > 99.5%), 1-hexanol (purity > 98%), cyclohexanol (purity > 99%), cyclohexane (purity > 99.5%), toluene (purity 99.5%), n-hexane (purity > 99%), sodium hydrogen carbonate (purity > 99.7%), sodium hydroxide (purity > 99%), di-sodium tetraborate decahydrate (purity > 99%), ethanol (purity > 99.8%), silver nitrate (purity > 99%), phthalic anhydride (purity > 98%) and benzoic acid (purity > 99%) were supplied by Merck (Germany), dibenzofuran (purity 98 %) by Acros Organics (Belgium), and 1,2-propanediol (purity > 99.5%), monosodium maleate (purity 99%), monobenzyl phthalate, hexahydrophthalic anhydride (purity 95%), hydroxypropyl- $\alpha$ -cyclodextrin with molar substitution of 0.6 (purity 99%), hydroxypropyl- $\beta$ -cyclodextrin with molar substitution of 0.6 (purity 99%) and hydroxypropyl- $\beta$ -cyclodextrin with molar substitution of 1.0 (purity 99%) by Sigma-Aldrich (USA). 1,2,4-trimethylbenzene (purity > 98.5%) was obtained from Fluka (Germany), whereas N,O-bis(trimethylsilyl)trifluoroacetamide (BSTFA) from Alltech (USA). All chemicals were used as received. MiliQ water was used in all experiments.

### 5.4.2 Reactive extraction of unmodified alcohol

For the reactive extraction of the unmodified alcohol, the set of jacketed glass cells already introduced in Chapter 4 (Figures 4.5 and 4.6) is used. Since the description of this setup is already given, only the details of the experimental procedure will be presented here.

The equilibrium measurements were performed as follows. Forty millilitres of the organic and 40 ml of the aqueous solution were introduced in each vessel. The alcohol mass fraction in the initial organic solution was 1.5 wt%, while the initial concentration of extractant in the aqueous phase varied between zero and its solubility. After introduction of both solutions, the lid is placed and the mixture was stirred at 450 rpm at a regime of 30 s stirring in one direction, 5 s pause and 30 s stirring in the other direction. After agitation (the time of agitation required to reach equilibrium was determined prior to equilibrium experiments) the mixture was left to settle for 1 h. During the agitation and settling, the temperature of the fluid in the vessels was kept constant at the required value with an uncertainty of 0.1 °C. After settling, 1 to 2 ml samples of both the organic and the aqueous layer were taken for quantitative analysis. The overall distribution ratio of the alcohol ( $D_{Alc}$ ) was preferably

calculated by dividing the measured total concentration of the alcohol in the aqueous phase by its concentration in the organic phase, at equilibrium:

$$D_{A/c} = \frac{c_{A/c}^a + r \cdot c_{CEA/c}^a}{c_{A/c}^o} \quad (5-2)$$

where subscript *A/c* represents alcohol and *CEA/c* the chemically extracted alcohol. *r* is the number of alcohol molecules per molecule of chemically extracted product (*r* = 1 in all reactions in Figure 5.2 with exception of the reaction with borate).

However, when the total concentration of the alcohol in the aqueous phase ( $c_{A/c}^a + c_{CEA/c}^a$ ) could not be determined due to limitations in the used analytical method, the overall distribution ratio is calculated from the measured concentration in the organic phase ( $c_{A/c}^o$ ) and the initial alcohol concentration in the organic solution ( $c_{A/c}^{o,0}$ ):

$$D_{A/c} = \frac{c_{A/c}^{o,0} - c_{A/c}^o}{c_{A/c}^o} \quad (V^a = V^o) \quad (5-3)$$

Before equation (5-3) is applied it is confirmed that the mass balance holds. Using pure water as the extraction solvent, i.e. having only physical extraction, the difference in the number of moles of the alcohol experimentally found in both phases at equilibrium and the initial number of moles present in the organic phase is found to be not larger than 2 %.

The selectivity of a solvent toward alcohol ( $\beta_{A/c}$ ) is calculated as the ratio of equilibrium distribution ratios of alcohol and apolar organic solvent (AOS):

$$\beta_{A/c} = \frac{D_{A/c}}{D_{AOS}} \quad (5-4)$$

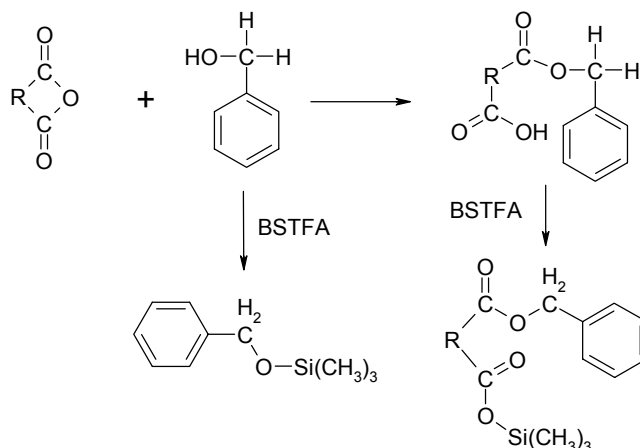
### 5.4.3 Reactive extraction of modified alcohol

**Monoesterification reaction.** The monoesterification reaction was analysed on the automated workstation described in detail in Chapter 2. The concentrations of reactants and product are measured as a function of reaction time. The reaction is performed in 20-ml vials closed by a metal crimp seal with septum, in which 17 ml of the organic solution containing the anhydride dissolved in the organic solvent (toluene, trimethylbenzene, cyclohexane, n-hexane) was introduced. In case of phthalic anhydride the solvent and anhydride were added separately since the anhydride could not be dissolved in these solvents at room temperature. The vial is placed in the orbital shaker on the automated workstation and heated to the required temperature (in the range of 60 - 150 °C) with an uncertainty of 1 °C. The shaking was done by applying 750 rpm, with 30 s of rotation in one direction, 5 s pause and 30 s rotation in the opposite direction. The reaction was initiated by introducing the alcohol in the vial. The quantity varied with experiment, but it was not higher than 1.5 wt%.

At predefined times, the robot arm took out the vial from the shaker and placed it in the adequate workstation's tray, where it was left to cool down for not longer than 15 to 20 min. Although the reaction continued also during the cooling, that effect is neglected since the reaction is much slower during cooling than at the temperatures evaluated in the experiments. Anyhow, cooling was necessary to eliminate eventual losses due to evaporation.

After that, a 60  $\mu$ l sample was taken by the syringe on the robot arm. Before sampling, the syringe was first washed in the pure organic solvent and subsequently in the reaction

medium. The sample was dispensed into a 2-ml vial that contained around 0.5 ml of a chemical derivatization agent (see Section 5.4.4 for more details about the derivatization). There, the sample is left for at least 30 min to allow complete derivatization of the monoester and the alcohol. After that, the derivatized sample was injected into the gas chromatograph (GC) for quantitative analysis. Before injection in the GC, the syringe was washed in the derivatization solution. The purpose of the derivatization was to enable chemical analysis of the monoester, but also to halt the reaction at the time the sample is taken and enable its continuation at the high temperatures during the analysis. This is done by converting all benzyl alcohol and monoester present in the sample into the inert silyl derivatives (see Scheme 5.12).



**Scheme 5.12** Conversion of alcohol and monoester into non-reactive silyl derivatives halts the monoesterification reaction (BSTFA is the derivatization agent – see Section 5.4.4).

In order to avoid any loss of chemicals through the opening made in the septa by sampling, especially at high temperatures, each vial was sampled only once. Therefore, the reaction is performed in parallel in seven vials and each one was sampled at a certain time. An eighth vial did not contain alcohol, whereas in the ninth there was no anhydride. The latter two vials were used to represent the concentration of anhydride or alcohol at the beginning of the reaction.

From the measured concentration in the organic solution ( $c_{Alc}$ ) and its initial concentration ( $c_{Alc}^0$ ), the alcohol conversion ( $\xi$ ) is calculated:

$$\xi_{Alc} = \frac{c_{Alc}^0 - c_{Alc}}{c_{Alc}^0} \quad (5-5)$$

**Dissociation extraction.** The dissociation extraction experiments are also performed on the automated workstation described in Chapter 2. The extraction is done in 2-ml vials in which 850  $\mu$ l (at the extraction temperature) of each phase is introduced. The organic phase was a 0.1 M solution of monobenzyl phthalate in toluene, representing the modified benzyl alcohol solution, whereas the aqueous phase contained sodium hydrogen carbonate or sodium hydroxide at different concentrations. After the solutions were introduced (preparation of the solutions and their introduction in the vials was done manually), the vials were closed and placed in the adequate tray on the automated workstation. The liquids and vials were preheated to the temperature of the experiment before introduction of the solutions, whereas the temperature in the tray during the extraction was kept at the required value with an uncertainty of 0.05  $^{\circ}$ C at 25  $^{\circ}$ C. During extraction, no agitation is applied. Absence of agitation is caused because pH probe occupied significant volume of the

experimental vessel and did not allow any agitation. As a compensation for a possible non-uniform concentration profile within the phase due to the absence of agitation, a significant amount of the organic phase was sampled.

At predefined times, the robot arm took a sample of 100  $\mu\text{l}$  of the upper, organic layer and transferred it into a 2-ml vial that contained around 0.5 ml of the derivatization agent. No samples of the aqueous phase were taken since the used chemical method did not allow analysis of the aqueous phase. Before sampling, the syringe was washed in the pure organic solvent. A sample is left for at least 30 min to allow complete derivatization of the monoester and alcohol. After that, the sample was injected into the gas chromatograph (GC) for quantitative analysis. Before injection in the GC, the syringe was washed in the derivatization solution.

Based on the definition given in equation (5-1), from the determined concentrations in the organic phase and the initial monoester concentration in the organic solution ( $c_{ME}^{o,o}$ ) the overall distribution ratio is calculated as:

$$D_{BAIc} = \frac{c_{ME}^{o,o} - (c_{ME}^o + c_{BAIc}^o)}{c_{ME}^o + c_{BAIc}^o} \quad (V^a = V^o) \quad (5-1a)$$

In order to avoid erroneous results due to the loss of chemicals through the opening made by sampling, especially at high temperatures, but also to maintain a constant phase ratio, each vial was sampled only once. Therefore, the extraction is performed in parallel in 10 vials.

The same extraction experiments were also performed in the 20-ml vials in which a pH probe could be introduced. These experiments were only used to give information about the pH of the aqueous phase during the extraction.

#### 5.4.4 Chemical analysis

The components were quantified either by a gas chromatograph (GC) CP-3800 system with an FID detector (Varian, USA), by a high-pressure liquid chromatograph (HPLC) Series 2500 (Varian) or by an HPLC Prostar (Varian). The characteristics of the methods used for specific cases are given below.

**Reactive extraction of unmodified alcohol.** For almost all cases, except when samples of the equilibrium experiments using aqueous cyclodextrin solutions were analysed, high-pressure liquid chromatography was used. Reverse phase chromatography is applied, where Kromasil (n-decyl  $C_8$  chains) [250 mm  $\cdot$  4.6 mm; 10  $\mu\text{m}$  size packing] was the stationary phase. UV detection at a wavelength of 254 nm was used for detection of the analytes. A mixture of methanol and ammonium acetate at a flowrate of 1 ml/min was used as the mobile phase.

The samples of the organic phase have been diluted in ethanol in the range of 100 to 1000 times and samples of the aqueous layer maximum 20 times, to be able to obtain the peaks within the reading range of the detector. The determination of the concentration of the components is based on previously established calibration curves, which relate the analyte concentration to its peak area.

Gas chromatography was used for determination of the concentrations in the experiments involving cyclodextrins. An ECTM-wax column (30 m length; 0.32 mm diameter; 0.25  $\mu\text{m}$  size packing) [Alltech, USA] was applied. The column temperature was raised from 100  $^\circ\text{C}$  to 240  $^\circ\text{C}$  with an increment of 40  $^\circ\text{C}/\text{min}$ . The split ratio was 40. Helium was used as the carrier gas with an initial flow of 11.8 ml/min. The duration of an analysis was 3.5 min. The



temperatures of the detector and injector were kept constant at 300 °C and 275 °C respectively, with a pressure in the injector of 276 kPa. Samples of 0.2 µl were injected into the column.

Quantification of the components in the sample was done by using an internal standard method where a 0.25 M solution of dibenzofuran in ethanol was used as the internal standard.

**Reactive extraction of modified alcohol.** Due to the poor stability of the monoesters, they had to be derivatized prior to chemical analysis. Silylation using N,O-bis(trimethylsilyl)trifluoroacetamide (BSTFA) was the applied derivatization method. This procedure was chosen since it enables fast conversion of monoesters, but also of alcohols into stable silyl derivatives, as well as because of its simplicity.<sup>62,63,64</sup> In each case the derivatization is done by introducing not more than 80 µl of a sample in around 500 µl of BSTFA and leaving the solution to react for at least 30 minutes at room temperature (the conversion does not require this time, but it is applied to be certain that everything is converted). After that the solution is injected into the column without any further treatment.

It should be mentioned that a very powerful silylating agent known under its commercial name as Power Sil-Prep [trimethylsilylimidazole, bis(trimethylsilyl) acetamide and trimethylchlorosilane in 3:3:2 ratio] was initially applied as the derivatization agent. However, no stable peak of monoester could be obtained.

Gas chromatography CP-SIL column (25 m length; 0.15 mm diameter; 1.2 µm size packing) [Varian] was used for this analysis. The column temperature was raised from 50 °C to 300 °C with an increment of 20 °C/min and, at the end, maintained at 300 °C for 5 min. The temperatures of detector and injector were kept constant at 300 °C and 270 °C respectively, with a pressure in the injector of 154 kPa and a split ratio of 100. Hydrogen was used as the carrier gas with an initial flow of 0.9 ml/min. The duration of an analysis was 17.5 min. The analysed alcohols were detected at 6.1 to 7.8 min, anhydrides at 6.1 to 9.0 min, and monoesters after 12 min. Quantification of the components was done applying an internal standard method where the apolar organic solvent present in the sample was used as the internal standard.

## 5.5 Results and Discussion

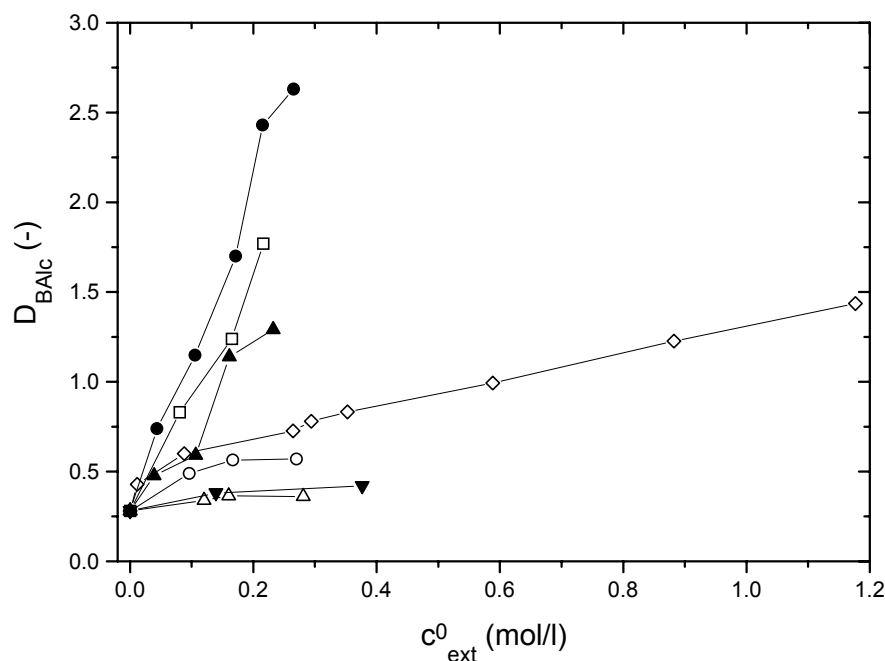
### 5.5.1 Reactive extraction of unmodified alcohol

The measured overall equilibrium distribution ratios of benzyl alcohol for all evaluated extractants are summarised in Figure 5.6. The points represent the experimental results and the lines show their trend. The results obtained for each extractant are discussed in subsections 5.5.1.1 - 5.5.1.5, whereas in subsection 5.5.1.6 the applicability of the evaluated extractants on different alcohols is considered.

To emphasise once again, the initial concentration of each extractant in the aqueous phase is varied between zero and its solubility limit, whereas the initial concentration of benzyl alcohol in the organic phase is the same in all cases (0.1 mol/l). The ratio of volumes of the aqueous and organic phase is 1.

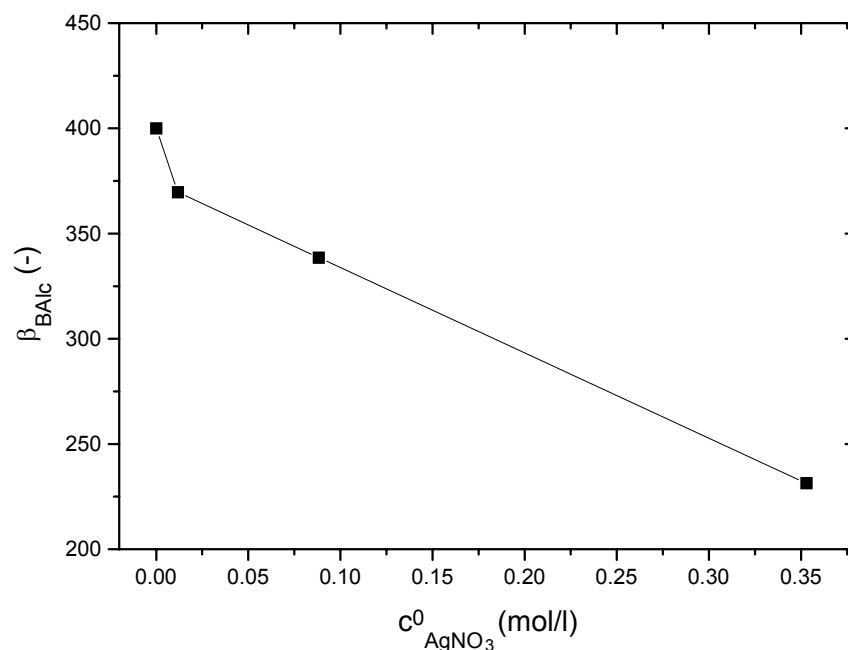
#### 5.5.1.1 Silver nitrate aqueous solution

Silver nitrate may improve the distribution ratio of benzyl alcohol by a factor of 5 relative to pure water. In other words, at concentrations close to saturation, its aqueous solution offers an extraction solvent with a fair distribution ratio of around 1.5.



**Figure 5.6** Overall equilibrium distribution ratio of benzyl alcohol between aqueous solution and toluene as a function of the initial extractant concentration in the aqueous phase at 25 °C:  $\diamond$ , silver nitrate;  $\square$ , hydroxypropyl- $\beta$ -cyclodextrin (AMS=1.0);  $\bullet$ , hydroxypropyl- $\beta$ -cyclodextrin (AMS=0.6);  $\blacktriangle$ , hydroxypropyl- $\alpha$ -cyclodextrin (AMS=0.6);  $\circ$ , sodium borate;  $\triangle$ , 1,2-propanediol-borate complex;  $\blacktriangledown$ , monosodium maleate. The initial mass fraction of benzyl alcohol in toluene is 1.5 wt% (0.1 mol/l). Phase volume ratio is 1.

On the other hand, the results on selectivity (see Figure 5.7) show that such a silver nitrate solution has lower selectivity toward benzyl alcohol relative to pure water, confirming the interaction of silver with both aromatic compounds in the solution. The decreasing trend of the selectivity in Figure 5.7 suggests even that the silver ion interacts more with toluene than with benzyl alcohol. Nevertheless, although the decrease occurs, the selectivity still remains rather high.



**Figure 5.7** Selectivity of aqueous silver nitrate solutions toward benzyl alcohol relative to toluene as a function of the initial  $\text{AgNO}_3$  concentration in the aqueous phase at 25 °C.  $w_{\text{BAlc}}^{o,o} = 1.5 \text{ wt\%}$  ( $c_{\text{BAlc}}^{o,o} = 0.1 \text{ mol/l}$ ).

Therefore, an aqueous solution of silver nitrate could be used as an extraction solvent for the recovery of benzyl alcohol. It provides a moderate capacity, with a still acceptable selectivity. The exact  $\text{AgNO}_3$  concentration at which this solution should be applied depends on the minimum selectivity that a specific process allows. The experimental data in Figure 5.7 are available only till 0.35 M concentration where the selectivity is still satisfactorily high. However, higher concentrations may lead to higher capacities toward benzyl alcohol, but at the cost of a further decrease in selectivity.

#### 5.5.1.2 Sodium borate aqueous solution

Not more than a two-times increase of the distribution ratio is obtained by sodium borate. This increase may be due to a weak complexation of the alcohol with borate, or just the result of a physical effect of the salt (salting-in). Anyhow, the aqueous borate solutions do not have sufficient potential to be used in the extraction of mono-alcohols. This confirms the doubts expressed earlier that a borate does not complex, at least not significantly, with mono-alcohols.

#### 5.5.1.3 Aqueous solution of 1,2-propanediol-borate complex

The influence of the diol-borate complex on the distribution ratio of benzyl alcohol seems to be negligible. Therefore, the interaction of such a complex with an alcohol may be considered as very weak, if it exists at all, discarding the possibility to use this compound for the required extraction.

#### 5.5.1.4 Monosodium maleate aqueous solution

As for the diol-borate complex, the effect of monosodium maleate on the distribution ratio of benzyl alcohol may be considered as minor, suggesting that the mono-salts of dicarboxylic acids are also not suitable for the reactive extraction of alcohols.

Besides a poor capacity of the monosodium maleate aqueous solution, also very slow esterification kinetics is observed. Even when benzoic acid, as an acidic catalyst, is present in the solution (although in low concentrations, due to its low water solubility), it takes several days to reach the equilibrium in an agitated two-phase system. Although any mineral acid is a better catalyst, its introduction involves contamination of the solution and effects its environmental and safety characteristics.

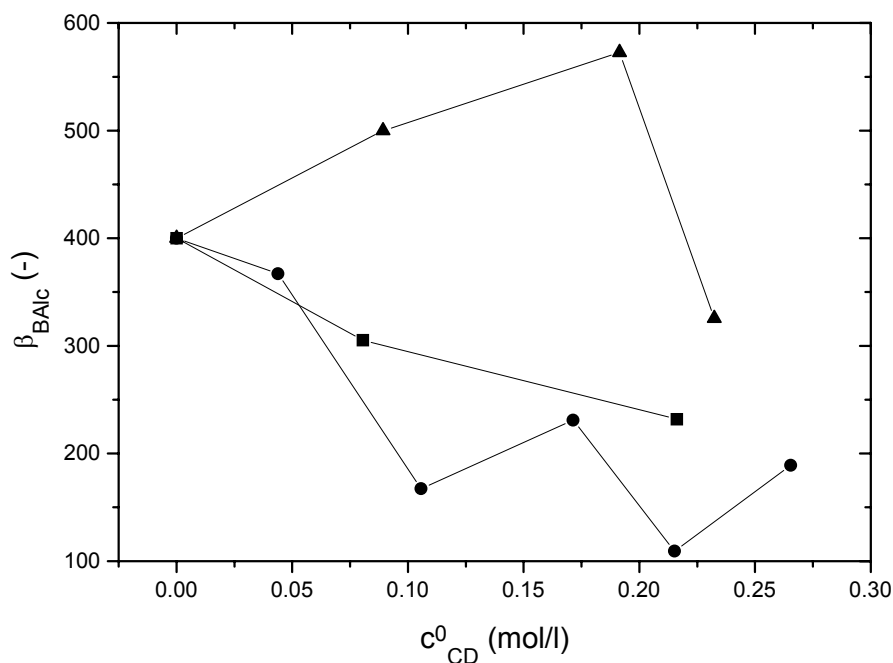
#### 5.5.1.5 Aqueous cyclodextrin solutions

All three evaluated cyclodextrins cause an increase of the distribution ratio of benzyl alcohol. The reached maximum values are between 1.3 and 2.7, what makes them the most attractive among the evaluated extractants.

Beta cyclodextrins show a higher distribution ratio than the alpha, whereas the  $\beta$ -cyclodextrin with the lower degree of substitution is somewhat better. Obviously, complexation of benzyl alcohol occurs also within the smaller cavity of an  $\alpha$ -cyclodextrin. However, it is not as pronounced as that with the cavity of  $\beta$ -cyclodextrins. An influence of the degree of substitution on the complexation, i.e. the distribution ratio, seems to exist. However, this effect should be further analysed on more cyclodextrins, with various degrees of substitution, to see if a cyclodextrin with a lower degree of substitution than those already evaluated will enhance distribution ratio even further.

The selectivity of these extractants toward benzyl alcohol is shown in Figure 5.8. A decrease in selectivity for  $\beta$ -cyclodextrin solutions relative to pure water can be seen, whereas for  $\alpha$ -cyclodextrin it is only safe to say that it is similar to the selectivity of pure

water. Although even an increase in selectivity for this cyclodextrin can be seen, this can be due to large experimental errors involved in the determination of low concentrations of toluene (estimated to be up to 40%). In any case, the lowest observed selectivity for the evaluated cyclodextrins is not less than 100, which is still rather high.



**Figure 5.8** Selectivity of aqueous cyclodextrin solutions toward benzyl alcohol as a function of the initial cyclodextrin concentration in the aqueous phase at 25 °C: ■, hydroxypropyl- $\beta$ -cyclodextrin (AMS=1.0); ●, hydroxypropyl- $\beta$ -cyclodextrin (AMS=0.6); ▲, hydroxypropyl- $\alpha$ -cyclodextrin (AMS=0.6).  $w_{BAlc}^{o,o} = 1.5$  wt% ( $c_{BAlc}^{o,o} = 0.06$  mol/l).

Hence, with a distribution ratio of around 3 (at solvent-to-feed ratio of one) and a selectivity toward the alcohol of at least 100, aqueous solutions of hydroxypropyl-cyclodextrins have potential to be used for the recovery of benzyl alcohol.

### 5.5.1.6 Extraction of different alcohols

Only hydroxypropyl-cyclodextrins and silver nitrate improved the distribution ratio of benzyl alcohol relative to pure water. However, they just came close to the desired value of the distribution ratio of at least 3 for benzyl alcohol (see Section 5.1). Because of only such moderate improvement of the distribution ratio of benzyl alcohol, and since their application on cycloaliphatic and linear aliphatic is questionable (the applicability of cyclodextrins is limited to benzyl alcohol or similar size alcohols, and of silver nitrate on alcohols which can provide  $\pi$ -interactions), reactive extraction is not investigated for cyclohexanol and 1-hexanol.

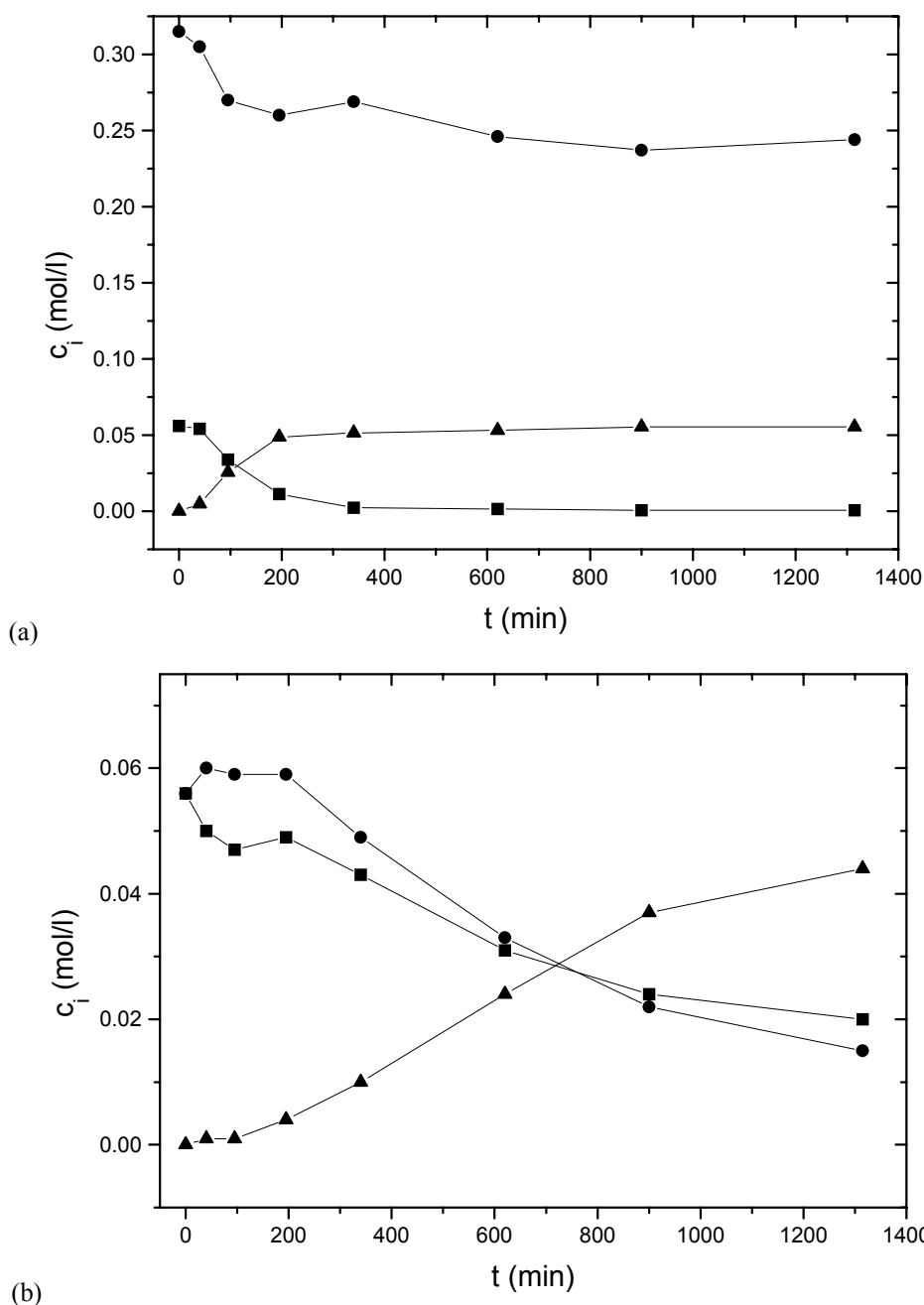
## 5.5.2 Reactive extraction of modified alcohol

### 5.5.2.1 Monoesterification reaction

The concentrations of alcohol, anhydride and monoester, in the non-catalysed monoesterification reaction performed in a dilute organic solution (less than 1 wt% of alcohol in the apolar organic solvent), are measured as a function of time at various temperatures. The alcohol conversions in those reactions are shown in Figures 5.10 - 5.14.

The points represent the experimental results, whereas the lines are involved to emphasise their trend.

However, before discussing the reaction rates and equilibrium conversions from those results, it is shown that the alcohol is indeed only consumed in the desired reaction, whereas no diesterification occurs. For that purpose, some typical results showing the concentration profiles of both reactants (alcohol and anhydride) and the product (monoester) in the reaction of benzyl alcohol with hexahydrophthalic anhydride are shown in Figure 5.9. Also in this case, the lines connecting the experimental points are introduced to emphasise their trend.



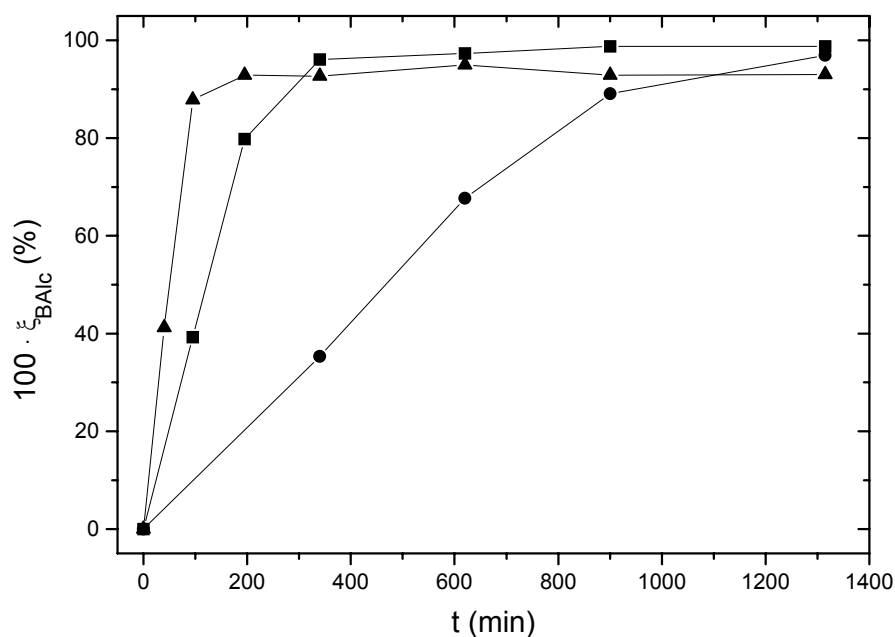
**Figure 5.9** Concentration as a function of time of the reactants and product in the monoesterification of benzyl alcohol with hexahydrophthalic anhydride in toluene at 100 °C when (a) anhydride is used in excess, and (b) when equimolar amounts of both reactants are used: -●-, hexahydrophthalic anhydride; -■-, benzyl alcohol; -▲-, monobenzyl hexahydrophthalate.

Both graphs in Figure 5.9 refer to the same reaction at the same temperature, but one for the case when the anhydride is used in excess and the other when an equimolar amount of both reactants is present. Showing both cases confirms that the outcome does not eventually change at different reactant ratio. From those graphs it can be seen that the rate of alcohol consumption is equal to that of the anhydride, and to the generation rate of monoester. This indeed suggests that the reaction in which one mole of both reactants is spent and one mole of product is generated, as in the desired reaction shown in Scheme 5.7, is occurring. Hence, this also means that there are no side reactions, like diesterification.

In case of the reaction of benzyl alcohol with phthalic anhydride it is confirmed that the product is really the desired monoester. This monoester, which is the only one commercially available of all generated, is analytically compared with the reaction product and is found to be the same. Although this is not done for the other reactions, it is at least indicated by a similar retention time in the used analytical chromatographic column, that the products of the other reactions are also monoesters.

Having confirmed that the measured concentration change of the alcohol indeed reflects the conversion into a monoester, the kinetics and equilibrium of these reactions can be discussed. First, the results of the reaction of benzyl alcohol with each of the three selected anhydrides in toluene are addressed (Figures 5.10, 5.12 and 5.13), and then those of the monoesterification of cyclohexanol and 1-hexanol with one of the anhydrides, in cyclohexane and n-hexane, respectively (Figure 5.14). Finally, the reaction rate equation is established and its parameters are determined for each analysed reaction. The quantification of the reaction equilibrium constants is also done.

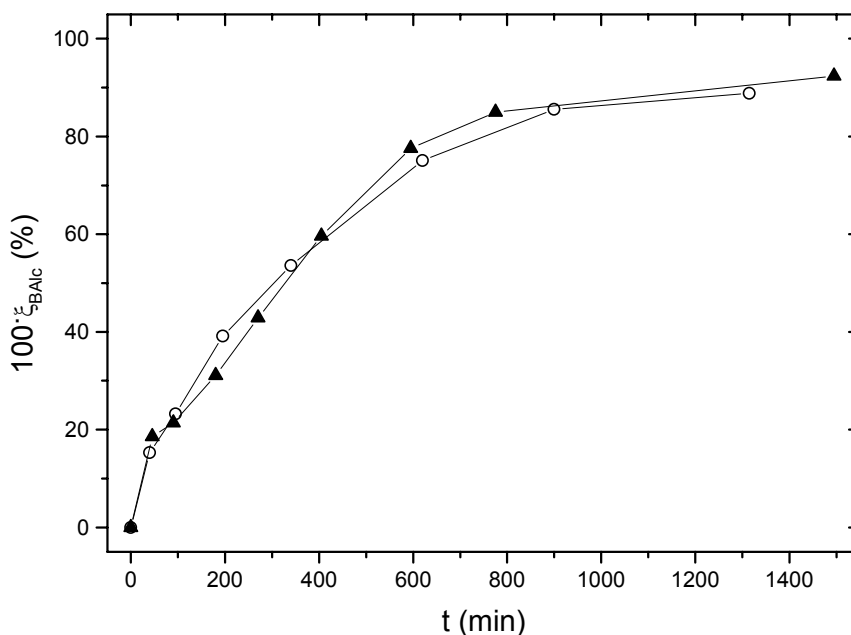
The conversion of benzyl alcohol in the reaction with hexahydrophthalic anhydride are given in Figure 5.10. In all graphs the anhydride is used in excess in an attempt to reach the equilibrium within the monitored time. Furthermore, since the objective is to evaluate if high conversions of an alcohol are feasible, using an excess of anhydride is preferable. A six-times-molar-excess is applied in all cases.



**Figure 5.10** Conversion of benzyl alcohol as a function of time and temperature in the reaction with hexahydrophthalic anhydride: -●-, 60 °C; -■-, 100 °C; -▲-, 150 °C.  $w_{BAlc}^{0,0} = 0.8$  wt% ( $c_{BAlc}^{0,0} = 0.06$  mol/l). A six-times-molar-excess of anhydride is used.

Under all evaluated conditions a conversion higher than 90% can be achieved using hexahydrophthalic anhydride. This conversion is exceeded in approximately 100 min at 150 °C, what can be considered as relatively fast if compared with a typical residence time in an oxidation reactor of 240 to 1800 min.<sup>66</sup> Since hexahydrophthalic anhydride has a good solubility in apolar solvents, the conversion and the reaction rate can be even higher than shown in Figure 5.10 by using a higher excess of anhydride. Regarding the temperature, the reaction seems to be exothermic. Furthermore, as expected, the reaction becomes faster as the temperature rises and if more anhydride is introduced (see also Figure 5.9).

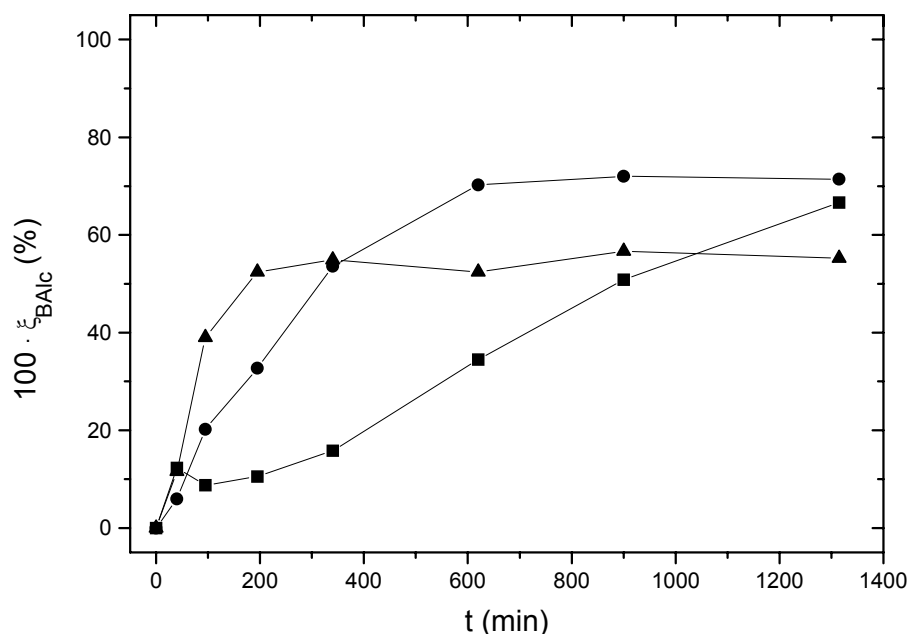
It should be emphasised that the measurements at 60 and 100 °C are performed in toluene, while those at 150 °C are actually obtained in 1,2,4-trimethylbenzene. The reason for the involvement of this solvent is the low boiling point of toluene (110 °C at atmospheric pressure). To be able to study the reaction at temperatures higher than 110 °C, either the pressure could be increased to prevent boiling, or a solvent similar to toluene, but with a higher boiling point, could be used. The second option is chosen as simpler such that 1,2,4-trimethylbenzene is selected because its structure is very similar to toluene, and its boiling point is above 160 °C. However, to be certain that the reaction proceeds at the same rate and to the same conversion in both solvents, the kinetics and conversion of monoesterification of benzyl alcohol in 1,2,4-trimethylbenzene at 100 °C is compared to that in toluene. The results are shown in Figure 5.11, from which it is clear that both the rate and the equilibrium conversion remain the same for both solvents. Therefore, 1,2,4-trimethylbenzene is used as solvent at temperatures when toluene could not be used.



**Figure 5.11** Comparison of the conversion of benzyl alcohol as a function of time in monoesterification with hexahydrophthalic anhydride at 100 °C: -▲-, in toluene; -○- in 1,2,4-trimethylbenzene.

The results on the monoesterification conversion of benzyl alcohol with phthalic anhydride are shown in Figure 5.12. Although again a six-times molar excess of anhydride is introduced in the solution, its actual concentration in the organic phase is lower and limited by its poor solubility. At 100 and 125 °C, solids of undissolved anhydride are visually observed during the whole course of the reaction. At 150 °C it couldn't be seen if all anhydride dissolved because at that temperature the anhydride is a liquid. However based on the observed differences when going from 100 to 125 °C it can be safely considered that an

additional increase in temperature of 25 °C is not sufficient to dissolve all introduced anhydride. Therefore, the concentration of anhydride during the reaction can be considered as constant and equal to its solubility at the specified temperature.



**Figure 5.12** Conversion of benzyl alcohol as a function of time and temperature in the reaction with phthalic anhydride: ■-, 100 °C; ●-, 125 °C; ▲-, 150 °C.  $w_{BAlc}^{o,o} = 0.8$  wt% ( $c_{BAlc}^{o,o} = 0.06$  mol/l). The anhydride concentration is equal to its solubility at each temperature.

As can be seen, the equilibrium conversion of benzyl alcohol is lower than achieved in the reaction with hexahydrophthalic anhydride. Also, this reaction proceeds slower. The explanation can be found in the low concentration of phthalic anhydride in the solution. Although the reaction equilibrium and rate constants could be the same as for hexahydrophthalic anhydride, still the low concentration of phthalic anhydride limits the equilibrium conversion and the reaction rate. This means that the rates and equilibrium conversions shown in Figure 5.12 are the maximum that can be achieved for benzyl alcohol if using this anhydride, since no higher anhydride concentrations can be employed.

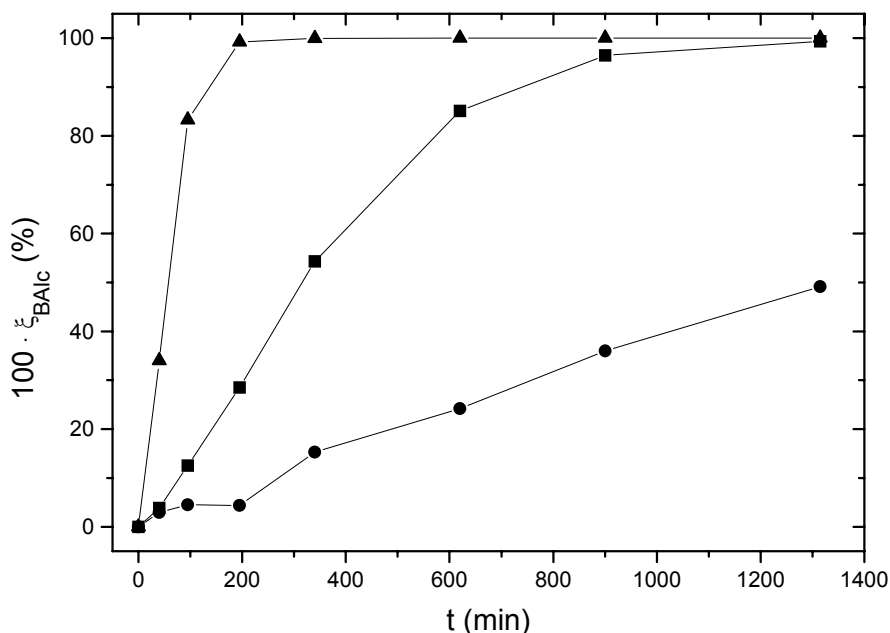
The results on the monoesterification of benzyl alcohol with 3-methyl glutaric anhydride are presented in Figure 5.13.

With 3-methyl glutaric anhydride, the highest equilibrium conversion of benzyl alcohol, compared to the previous two, is achieved. At 150 °C, the alcohol conversion into the monoester is almost 100%, whereas at the lower temperatures the equilibrium is not reached within the monitored time. However, assuming an exothermic reactions, as seen earlier in reactions with phthalic and hexahydrophthalic anhydrides, it can be concluded that conversions at those temperatures are also approaching 100%. Such results suggest that the excess of anhydride does not need to be as high as used in these experiments to obtain high conversions of an alcohol. On the other hand, the reaction rate in this case seems to be much more sensitive to the temperature than with either hexahydrophthalic or phthalic anhydrides.

Hence, the highest equilibrium conversions at reasonable reaction rates make 3-methyl glutaric anhydride the best modifier for benzyl alcohol. This may be influenced by different parameters of the alcohol and anhydride interaction, i.e. it can be different for a different alcohol. However, at this stage the mechanism of the interaction is not evaluated. Therefore, based on the performance with benzyl alcohol, 3-methyl glutaric anhydride is selected for



the experimental evaluation of the monoesterification reaction with the other two alcohols. The results of these reactions are shown in Figure 5.14.



**Figure 5.13** Conversion of benzyl alcohol as a function of time and temperature in the reaction with 3-methyl glutaric anhydride: -●-, 60 °C; -■-, 100 °C; -▲-, 150 °C.  $w_{BAIc}^{o,o} = 0.8$  wt% ( $c_{BAIc}^{o,o} = 0.06$  mol/l). A six-times-molar-excess of anhydride is used.

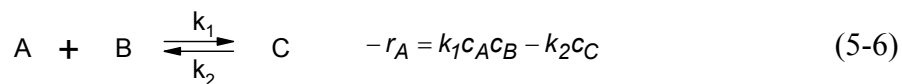
As in the evaluation of the conversion of benzyl alcohol, at temperatures higher than the boiling point of the original solvent, 1,2,4-trimethylbenzene is used as the solvent. Based on the evaluation done for benzyl alcohol, it is assumed that the effect of the solvent for these alcohols is also not significant.

An exothermic reaction is found for 1-hexanol, whereas for cyclohexanol the thermal character of the reaction can not be defined since the equilibrium is not even approached at 60 and 100 °C.

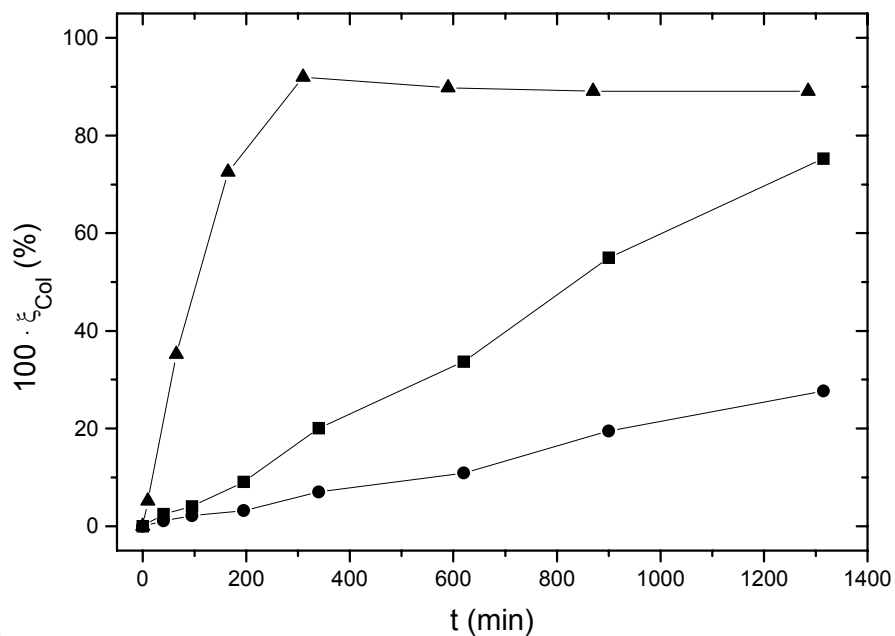
It can be seen that, at the same temperature, the reaction rate decreases in the order 1-hexanol > benzyl alcohol > cyclohexanol. The rate sensitivity on temperature, i.e. the activation energy, seems to be similar for benzyl alcohol and cyclohexanol, whereas it is lower for 1-hexanol. On the other hand, the lowest equilibrium conversion at 150 °C is found for 1-hexanol. It is only around 50%, compared with 90% for cyclohexanol and close to 100% for benzyl alcohol. The reasons for these differences will not be discussed here since that is out of the scope of the current investigation. In any case, it is confirmed that different alcohols can be efficiently modified into monoesters.

To quantify above-discussed findings on the reaction rates and equilibrium, the reaction equilibrium constants and the rate constants are determined from the experimental data.

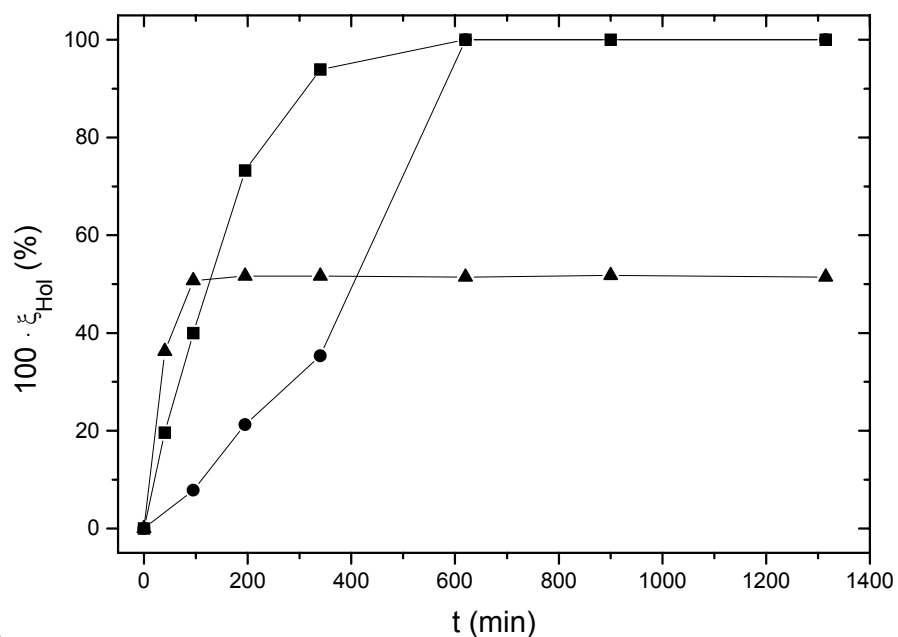
The first step is to determine the reaction rate equation. According to the literature, the monoesterification is first order with respect to both reactants.<sup>43</sup> However, those reports do not consider the reaction as reversible because no influence of the product concentration is involved. Therefore, we assume the rate equation as a reversible reaction with first order kinetics with respect to each of the reactants, but also to the product:



$A$  represents alcohol,  $B$  anhydride and  $C$  the monoester.  $c_A$  is its concentration at time  $t$ ,  $k_1$  and  $k_2$  are reaction rate constants and  $r_A$  is the reaction rate.



(a)



(b)

**Figure 5.14** Conversion of cyclohexanol (a) and 1-hexanol (b) as a function of time at various temperatures in the reaction with 3-methyl glutaric anhydride:  $\bullet$ -,  $\circ$ - 60 °C;  $\blacksquare$ -,  $\square$ -100 °C;  $\blacktriangle$ -,  $\triangle$ - 150 °C.  $w_{A/c}^{o,o} = 0.8$  wt%. A six-times-molar-excess of anhydride is used.

The integrated rate equation when  $c_C^0$  is equal to zero and  $c_A^0 \neq c_B^0$ , is:<sup>65</sup>

$$k_1 \cdot t = \frac{(c_A^0 - c_A^e)}{c_A^0 \cdot c_B^0 - (c_A^0 - c_A^e)^2} \ln \frac{(c_A^0 - c_A^e) \cdot [c_A^0 \cdot c_B^0 - (c_A^0 - c_A^e) \cdot (c_A^0 - c_A)]}{c_A^0 \cdot c_B^0 [(c_A^0 - c_A^e) - (c_A^0 - c_A)]} \quad (5-7)$$

where  $c_A^0$  and  $c_B^0$  are initial concentrations of reactants,  $c_A^e$  is the concentration of alcohol at equilibrium.

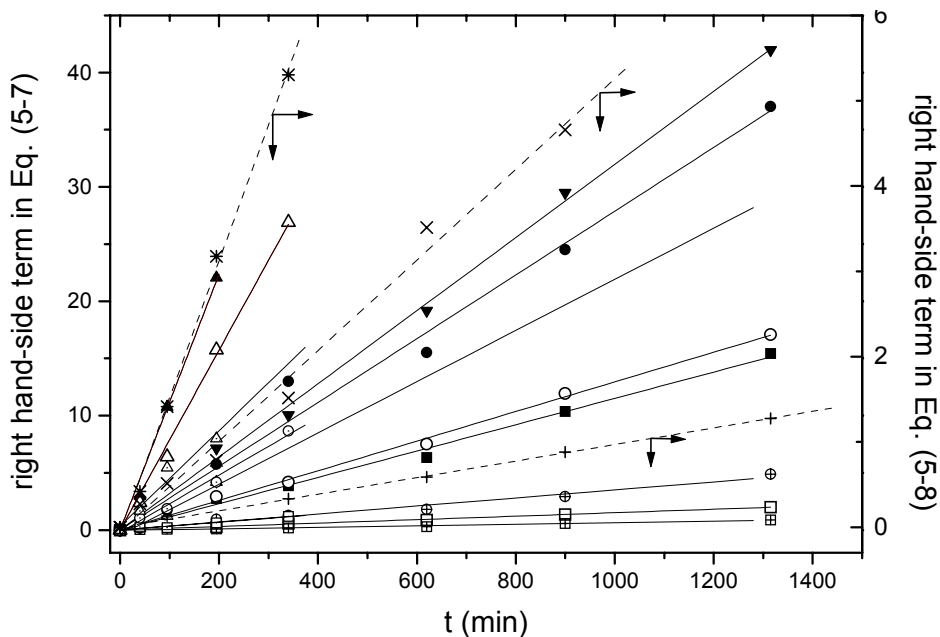
However, in the experiments with phthalic anhydride the anhydride concentration may be assumed constant during the reaction (equal to the anhydride solubility  $c_B^{sol}$ ), such that the reaction can be treated as pseudo zero order with respect to anhydride:

$$-r_A = (k_1 \cdot c_B^{sol}) \cdot c_A - k_2 c_C = k_1' \cdot c_A - k_2 c_C \quad (5-6a)$$

and the integrated rate equation is:

$$k_1' \cdot t = \ln \frac{(c_A^0 - c_A^e)}{(c_A - c_A^e)} \quad (5-8)$$

The right-hand-side term of either equation (5-7) or (5-8) for each reaction at each measured temperature is plotted as a function of time in Figure 5.15 (points). Equation (5-7) is used for experimental results presented in Figures 5-10 and 5-13 to 5-14, whereas equation (5-8) is employed for the results shown in Figure 5-12.



**Figure 5.15** The right-hand-side term of equation (5-7) and (5-8) as a function of time for all evaluated reactions (presented in Figures 5-10 and 5-12 to 5-14).

It is concluded that the experimental results can be successfully fitted by linear curves (lines in Figure 5.15), suggesting that the proposed reaction rate equation is indeed adequate. After that, for the reactions which are far from the equilibrium (see Figures 5.10 and 5.12-5.14), the equilibrium concentration is determined by finding the best linear fit. The obtained slope of each graph represents the reaction rate constant. Those for the same reaction are

fitted as a function of temperature by an Arrhenius-type of equation, yielding the activation energy and pre-exponential constant. The obtained correlations are given in Table 5.1.

**Table 5.1** Experimentally determined monoesterification rate constants ( $k_1$ ) and equilibrium constants (K).

| Anhydride         | $k_1$ (l/mol min)                                 | K (l/mol)   |
|-------------------|---|---|
| Benzyl alcohol    |   |   |
| Hexahydrophthalic | $4.6 \cdot 10^2 \cdot \exp(-3.0 \cdot 10^4/RT)$   | $2.3 \cdot 10^{-5} \cdot \exp(5.1 \cdot 10^4/RT)$ |
| 3-Methylglutaric  | $1.9 \cdot 10^5 \cdot \exp(-5.2 \cdot 10^4/RT)$   | very high   |
| Phthalic          | $2.2 \cdot 10^7 \cdot \exp(-7.4 \cdot 10^4/RT)^a$ | <sup>b</sup>                                      |
| Cyclohexanol      |   |   |
| 3-Methylglutaric  | $7.9 \cdot 10^3 \cdot \exp(-4.5 \cdot 10^4/RT)$   | $4.7 \cdot 10^{-2} \cdot \exp(2.2 \cdot 10^4/RT)$ |
| 1-Hexanol         |   |   |
| 3-Methylglutaric  | $5.9 \cdot 10^2 \cdot \exp(-3.3 \cdot 10^4/RT)$   | very high   |

<sup>a</sup> Represents  $k'_1$ , i.e. the product of the rate constant and the solubility of anhydride  $k_1 \cdot c_B^{sol}$  (1/min) [see Equation 5-6a].

<sup>b</sup> Not calculated since the solubilities of phthalic anhydride are not determined.

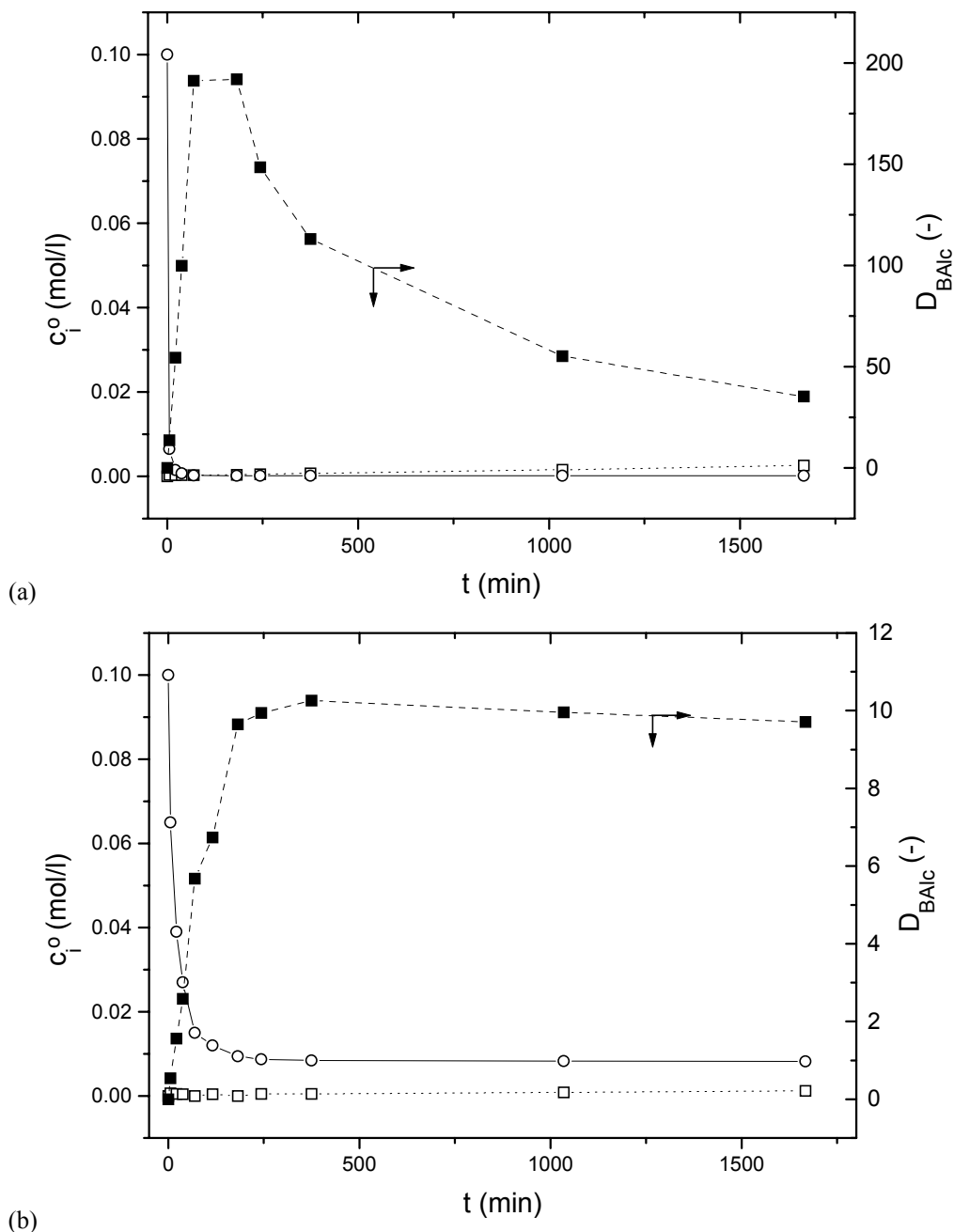
### 5.5.2.2 Dissociation extraction

Figures 5.16 and 5.17 show the concentration profiles of benzyl alcohol and monobenzyl phthalate in the organic phase, and the calculated distribution ratio (see equation 5-1), for the extraction by an aqueous solution of sodium hydrogen carbonate and sodium hydroxide, respectively. The upper graph in both figures gives the results when the salt is used in excess, whereas in the lower graph the extractant (salt) and solute (monobenzyl phthalate) are present in equimolar amounts. The points represent the experimental data, whereas the lines are involved to emphasise their trend.

As expected, in all graphs the distribution ratio raises from zero toward a maximum, after which it decreases toward the asymptote determined by the physical distribution ratio of the alcohol (around 0.3 for benzyl alcohol at this temperature). However, the value of the reached maximum, as well as the value at the end of monitoring, differ from case to case.

The main conclusion which can be drawn from Figure 5.16 is that an aqueous sodium hydrogen carbonate solution can be used for the extraction of monobenzyl phthalate. A distribution ratio of around 200 is reached when  $\text{NaHCO}_3$  is used in excess. This is a three orders of magnitude increase of the distribution ratio relative to the physical distribution ratio of benzyl alcohol in pure water.

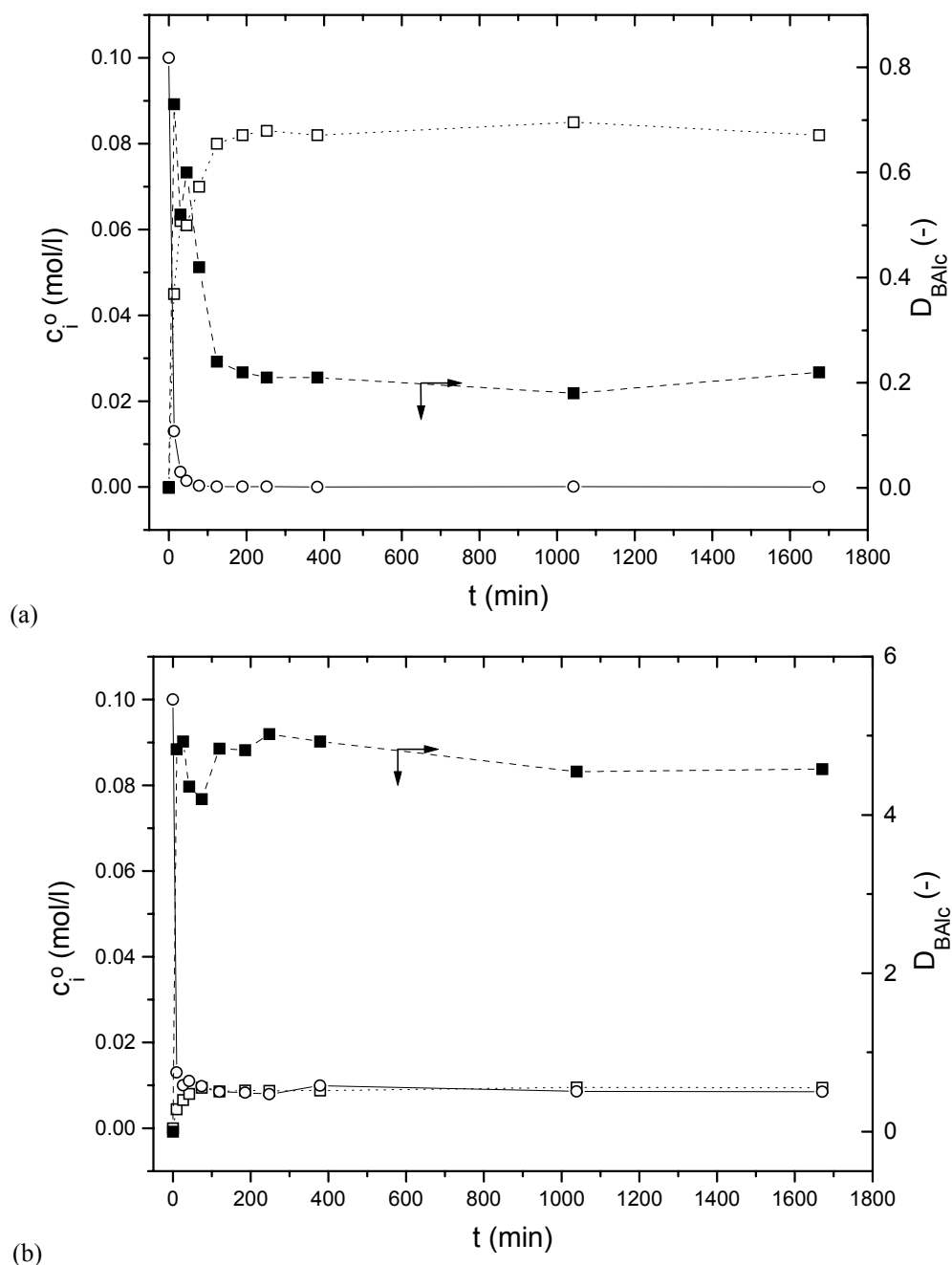
When  $\text{NaHCO}_3$  is in excess, the pH of the aqueous phase during the extraction is almost constant below 9. As can be seen from the monoester concentration profile in Figure 5.16a, which reaches zero, this pH is sufficient to enable a complete extraction of the monoester. On the other hand, the hydrolysis of the extracted monoester is proceeding at a much lower rate than at pH above 14, as seen in Figure 5.17. Not more than several percents of the extracted monoester hydrolyses in around 30 h. Hence, it can be concluded that the sodium hydrogen carbonate obviously has the desired characteristics for an extractant, it enables complete dissociation of the monoester, but does not cause vary fast hydrolysis. A relatively slow hydrolysis enables to maintain the distribution ratio at high values for a longer period of time.



**Figure 5.16** Concentration of the components in the organic phase ( $c_i^o$ ) [open symbols] and overall distribution ratio of benzyl alcohol ( $D_{BAIC}$ ) [solid symbol] as a function of time in the extraction of the modified alcohol at 50 °C into a (a) 1 M and (b) 0.1 M  $\text{NaHCO}_3$  aqueous solution: -□-, benzyl alcohol; -○-, monobenzyl phthalate. The phase volume ratio is 1.

When the hydrogen carbonate concentration is 0.1 mol/l, i.e. for equimolar amounts of monoester and extractant, the maximum distribution ratio of around 10 is achieved. During this extraction, the pH of the aqueous phase decreases from above 9, in the beginning, to around 6 at the end of monitoring, whereas the largest decrease occurs in the initial stage of the extraction. From the alcohol concentration profile (see Figure 5.16b) it is obvious that the monoester hydrolysis is very slow in this pH range. In the same time, the monoester is also extracted into the aqueous phase. This results in an efficient extraction, in which a maximum of around 10 is reached which, due to the very slow hydrolysis, remains almost constant in the whole period of monitoring. Having a pH of 6 at the end of monitoring suggests that

roughly all  $\text{NaHCO}_3$  is consumed in the extraction. However, the final concentration of monoester in the organic phase does not go lower than 0.01 mol/l. This indicates that not all extractant is used for the dissociation of monoester, but certain losses occur. Therefore, the maximum distribution ratio does not go higher than 10. However, this implies that if either the sources of the losses are eliminated or if  $\text{NaHCO}_3$  is used in slight excess, the maximum of the distribution ratio will go toward the values reached in Figure 5.16a.



**Figure 5.17** Concentration of the components in the organic phase ( $c_i^o$ ) [open symbols] and overall distribution ratio of benzyl alcohol ( $D_{BAIC}$ ) [solid symbol] as a function of time in the extraction of the modified alcohol at 50 °C into a (a) 2 M and (b) 0.1 M NaOH aqueous solution:  $-\square-$ , benzyl alcohol;  $-\circ-$ , monobenzyl phthalate. The phase volume ratio is 1.

When NaOH is used as extractant and in excess, the pH of the aqueous phase remains constant above 14. Such a high pH ensures efficient extraction of the monoester into the

aqueous phase, as can be seen from the monoester concentration profile in Figure 5.17a. However, in the same time, in such a basic medium the hydrolysis of the deprotonated monoester in water obviously occurs at a very high rate regenerating benzyl alcohol very rapidly and causing a quick loss of the extracted alcohol (see alcohol concentration profile in Figure 5.17a). Within the time the extraction is monitored, all monoester has been extracted into the aqueous phase, but also completely hydrolysed into benzyl alcohol. The complete hydrolysis is assumed since the distribution ratio reached the value of the physical distribution ratio of benzyl alcohol. Due to this rapid hydrolysis, the overall distribution ratio does not reach a value higher than 1 in this case.

The pH of the aqueous phase during the extraction shown in Figure 5.17b decreases from 14 to 6 due to the consumption of NaOH. Again, NaOH enables an efficient dissociation of the monoester and its extraction into the aqueous phase (see monoester profile in Figure 5.17b). On the other hand, from the alcohol concentration profile in the same figure, it can be seen that the hydrolysis is fast in the beginning, but becomes slower as pH decreases. At the end of monitoring, not more than 15% of the extracted alcohol hydrolysed, whereas the largest part of the hydrolysis occurs at the initial stage (when pH is in the range 14.3 to 13). Due to slower hydrolysis than when NaOH is in excess, a higher maximum distribution ratio is reached. In this case the maximum value of around 5 is found, what is a 25 times increase in comparison with the physical distribution ratio of benzyl alcohol in pure water. Again, as for sodium hydrogen carbonate, having a pH value of 6 at the end of monitoring suggests that all NaOH is consumed in this extraction. However, since the final concentration of monoester in the organic phase does not go much lower than 0.01 mol/l, again certain losses of the extractant may be recognised. If the losses are eliminated the maximum distribution ratio may go higher than reached in this experiment. However, if NaOH is used in a slight excess, due to its strong basicity which enhances hydrolysis (even if present in a low concentration, pH can be very high), a not too high distribution ratio will be reached.

At the end, it should be emphasised that for the case of modified alcohol extraction, no influence of the mass transfer rate is evaluated. However, although the results may be different under different hydrodynamic conditions, still it is confirmed that very high values of the distribution ratio can be achieved. To be able to find optimal extraction conditions, all parameters listed in Section 5.3.2 need to be determined. From the results in Figures 5.16 and 5.17, hydrolysis constants at different pH values and monoester dissociation constant can be derived, but first the values of the mass transfer coefficients of both monoester and benzyl alcohol, and the physical distribution ratio of monoester, have to be known (see Figure 5.4).

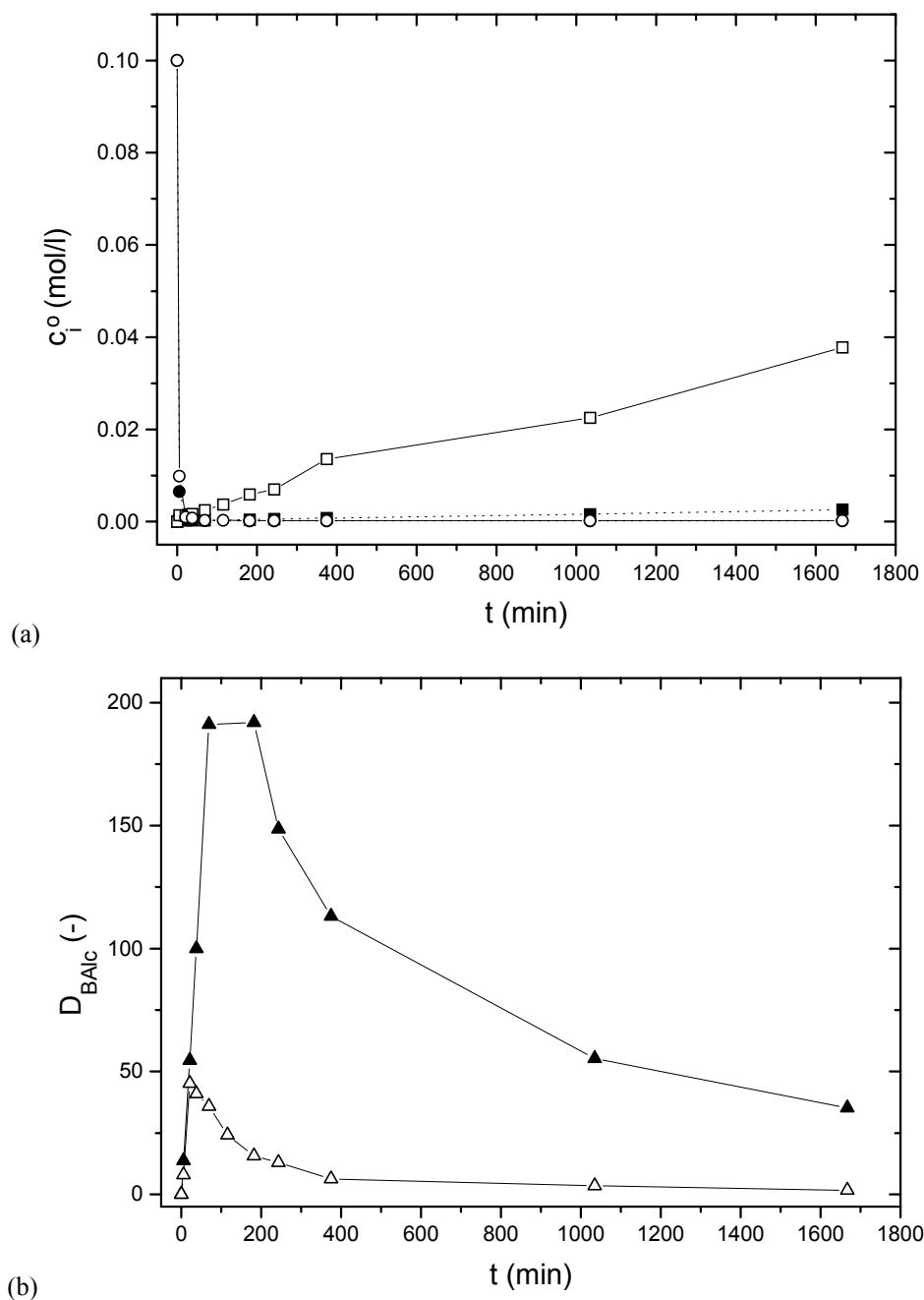
### 5.5.2.3 Regeneration of alcohol by a temperature shift

In order to evaluate the feasibility of a regeneration of benzyl alcohol from the extracted monoester by a temperature shift, the extractions at 50 and at 70 °C are compared. The results are shown in Figure 5.18.

The most important finding concerning the regeneration by a temperature shift is a much steeper increase of the benzyl alcohol concentration in the organic phase at 70 than at 50 °C (see Figure 5.18a). The results show a nearly ten-times faster hydrolysis rate due to this temperature increase. Therefore, the conclusion is that the rate of hydrolysis, i.e. alcohol regeneration, can be indeed controlled by the temperature.

On the other hand, the monoester concentration profile at 70 °C is the same as that at the lower temperature, showing no noticeable influence of temperature on the extractability of

the monoester. However, the faster hydrolysis at 70 °C results in a very different overall distribution ratio profile, emphasising the importance of all involved phenomena.



**Figure 5.18** (a) Concentration of the components in the organic phase ( $c_i^o$ ) and (b) overall distribution ratio of benzyl alcohol ( $D_{BAlc}$ ) as a function of time in the extraction of modified alcohol into a 1 M NaHCO<sub>3</sub> aqueous solution at 50 °C [solid symbols] and 70 °C [open symbols]: -□- and -■-, benzyl alcohol; -○- and -●-, monobenzyl phthalate. The phase volume ratio is 1.

## 5.6 Conclusions

Two approaches of applying reactive extraction for the recovery of low- or moderately-soluble monohydroxyl alcohols from an apolar organic solvent are evaluated. The first, in which an aqueous solution containing a reactive extractant is applied for extraction of



unmodified alcohol shows limited potential to be applied. Among several evaluated extractants, only hydroxypropyl-cyclodextrins and silver nitrate improve the distribution ratio of benzyl alcohol between the aqueous and organic phase. However, even they only come close to the desired value of the distribution ratio, which is set to at least one order of magnitude increase relative to the physical distribution ratio (the maximum achieved distribution ratio is 2.7, compared to 0.3 of the physical distribution ratio). Furthermore, the applicability of these two extractants is limited to benzyl alcohol or similar size and structure alcohols (interaction with the cyclodextrins is based on the size and structure of the alcohol molecule), or in case of silver nitrate, eventually to aromatic or unsaturated alcohols (interaction is based on existence of  $\pi$ -interaction sites).

The second considered approach, in which the alcohol is modified prior to the extraction into an easy-extractable form, in this case a monoester, shows much greater potential. A benign solvent, like an aqueous solution of sodium hydrogen carbonate, can provide a distribution ratio of benzyl alcohol up to 200, with an unchanged solubility of toluene in the aqueous phase relative to pure water. Therefore, this option is capable of increasing the distribution ratio, but also the selectivity, by several orders of magnitude compared with pure water.

It is shown that the modification of various alcohols (benzyl alcohol, cyclohexanol and 1-hexanol) into a monoester can be done efficiently in an apolar organic solvent, without need for a catalyst. If performed in the reactor in which the alcohol is generated (see oxidation processes in Chapter 1), this modification can even offer the opportunity to increase the reactant conversion while maintaining the required alcohol selectivity. Monoesters, which contain a carboxylic group, are efficiently extracted by dissociation extraction, what is evaluated by applying aqueous solutions of sodium hydrogen carbonate or sodium hydroxide. Extraction of the benzyl alcohol monoester shows that this extraction is very sensitive to pH, and that too basic salts, like sodium hydroxide, do not offer a high increase of the distribution ratio. Back-recovery of the extracted modified alcohol (monoester) can be performed by a spontaneous hydrolysis reaction which rate can be controlled by temperature. An increase of the temperature of 20 °C shows an enhancement of the hydrolysis rate by a factor of ten.

Hence, in this work the potential feasibility of the reactive extraction of modified alcohols is demonstrated. However, to be able to optimise this separation option, detailed analysis of the interactions of cyclic anhydrides with alcohols should be done in order to find optimal cyclic anhydride for conversion of a specific alcohol. Then, all parameters which are determining the distribution ratio profile during the extraction, or the rate of alcohol regeneration in the back-recovery after extraction, have to be quantified to establish optimal conditions for those steps. Finally, the proposed regeneration of anhydride needs also experimental validation.

## Literature Cited

- (1) Pai, R. A.; Doherty, M. F.; Malone, M. F. Design of Reactive Extraction Systems for Bioproduct Recovery. *AIChE J.* **2002**, *48*, 514-526.
- (2) King, C. J. Separation Processes Based on Reversible Chemical Complexation. In *Handbook of Separation Process Technology*; Rousseau, R. W., Ed.; John Wiley & Sons: New York, 1987.
- (3) Malinowski, J. J. Reactive Extraction for Downstream Separation of 1,3-Propanediol. *Biotechnol. Prog.* **2000**, *16*, 76-79.
- (4) Broekhuis, R. R.; Lynn, S.; King, C. J. Recovery of Propylene Glycol from Dilute Aqueous Solutions via Reversible Reaction with Aldehydes. *Ind. Eng. Chem. Res.* **1994**, *33*, 3230-3237.
- (5) Murto, J. Hydroxide-Alkoxide Ion Equilibria. In *The Chemistry of the Hydroxyl Group*; Patai, S., Ed.; Interscience Publishers: London, 1971.
- (6) March, J. *Advanced Organic Chemistry*; John Wiley & Sons: New York, 1992.
- (7) Solomons, T. W. G. *Fundamentals of Organic Chemistry*, 4th ed.; John Wiley & Sons: New York, 1994.
- (8) Harvard University. Department of Chemistry and Chemical Biology. Research & Faculty. Professor David Evans Group. <http://daecr1.harvard.edu/pKa/AlcoholsOximesPeroxides.gif> (last accessed July 2003).
- (9) Wise, E. T.; Weber, S. G. A Simple Partitioning Model for Reversibly Cross-Linked Polymers and Application to the Poly(Vinyl Alcohol)/Borate System ("Slime"). *Macromolecules.* **1995**, *28*, 8321-8327.
- (10) Keita, G.; Ricard, A.; Audebert, R.; Pezron, E.; Leibler, L. The Poly(Vinyl Alcohol) - Borate System: Influence of Polyelectrolyte Effects on Phase Diagrams. *Polymer.* **1995**, *36*, 49-54.
- (11) Chen, C. Y.; Yu, T. Dynamic Light Scattering of Poly(Vinyl Alcohol) - Borax Aqueous Solution Near Overlap Concentration. *Polymer.* **1997**, *38*, 2019-2025.
- (12) Tsuchiya, H. High-Performance Liquid Chromatographic Analysis of Polyhydroxyflavones Using Solid-Phase Borate-Complex Extraction. *J. Chrom. B.* **1998**, *720*, 225-230.
- (13) Abe, Y.; Shoji, T.; Kobayashi, M.; Qing, W.; Asai, N.; Nishizawa, H. Enantioselective Distribution of Amino-Alcohols in a Liquid-Liquid Two-Phase System Containing Dialkyl L-Tartrate and Boric Acid. *Chem. Pharm. Bull.* **1995**, *43*, 262-265.
- (14) Pizer, R. D.; Tihal, C. A. Mechanism of Boron Acid/Polyol Complex Formation: Comments on the Trigonal/Tetrahedral Interconversion on Boron. *Polyhedron* **1996**, *15*, 3411-3416.
- (15) Kobayashi, M.; Kitaoka, Y. Complex Formation of Boric Acids with Di- and Tri- Carboxylic Acids and Poly(Vinyl Alcohol) in Aqueous Solutions. *Macromol. Symp.* **1997**, *114*, 303-308.
- (16) Ishihara, K.; Mouri, Y.; Funahashi, S.; Tanaka, M. Mechanic Study of the Complex Formation of Boric Acid. *Inorg. Chem.* **1991**, *30*, 2356-2360.
- (17) Shibayama, M.; Sato, M.; Kimura, Y.; Fujiwara, H.; Nomura, S. <sup>11</sup>B n.m.r. Study on the Reaction of Poly(Vinyl Alcohol) with Boric Acid. *Polymer* **1988**, *29*, 336-340.
- (18) Pizer, R.; Tihal, C. Equilibria and Reaction Mechanism of the Complexation of Methylboronic Acid with Polyols. *Inorg. Chem.* **1992**, *31*, 3243-3247.
- (19) Burfeind, J.; Schügerl, K. Reaktiv-Membran-Extraktion von Ethanol. *Chem. Ing. Technik.* **1999**, *71*, 93-96.
- (20) Szejtli, J. *Cyclodextrin Technology*; Kluwer Academic Publishers: Dordrecht, 1988.
- (21) Szejtli, J. The Properties and Potential Uses of Cyclodextrin Derivatives. *J. Incl. Phenomena and Molecular Recognition in Chemistry.* **1992**, *14*, 25-36
- (22) CTD, Inc. Product information. Physico-Chemical Information on Trappsol. <http://www.cyclodex.com> (last accessed Oct 2002).

- (23) CyDex, Inc. Newsletter. Vol 1 Iss2. <http://www.cydexinc.com/CyclVol1Iss2.pdf> (last accessed Feb 2003).
- (24) Sanemasa, I.; Akamine, Y. Association of Benzene and Alkylbenzenes with Cyclodextrins in aqueous medium. *Bull. Chem. Soc. J.* **1987**, *60*, 2059-2066.
- (25) Rymden, R.; Carlfors, J.; Stilbs, P. Substrate Binding to Cyclodextrins in Aqueous Solution: A Multicomponent Self-Diffusion Study. *J. Inclusion Ph.* **1983**, *1*, 159-167.
- (26) Matsui, Y.; Mochida, K. Binding Forces Contribution to the Association of Cyclodextrin with Alcohol in an Aqueous Solution. *Bull. Chem. Soc. J.* **1979**, *52*, 2808-2814.
- (27) Siimer, E.; Kobu, M. Thermochemical Study of Cyclodextrin Inclusion Complexes. *Thermoch. Acta* **1990**, *170*, 89-95.
- (28) Szejtli, J.; Osa, T. Cyclodextrins. In *Comprehensive Supramolecular Chemistry, Vol. 3*; Atwood, J. L.; Davies, J. E. D.; Macnicol, D. D.; Vogtle, F., Eds.; Elsevier Science: Oxford, 1996.
- (29) Rekharsky, M. V.; Inoue, Y. Complexation Thermodynamics of Cyclodextrins. *Chem. Rev.* **1998**, *98*, 1875-1917.
- (30) Ross, P.D.; Rekharsky, M. V. Thermodynamics of Hydrogen Bond and Hydrophobic Interactions in Cyclodextrin Complexes. *Biophysical J.* **1996**, *71*, 2144-2154.
- (31) Rege, S. U.; Padin, J.; Yang, R. T. Olefin/Paraffin Separations by Adsorption:  $\pi$ -Complexation vs. Kinetic Separation. *AIChE J.* **1998**, *44*, 799-809.
- (32) Munakata, M.; Wu, L. P.; Ning, G. L. A New Type of Multilayer System - Silver(I) Complexes of Polycyclic Aromatic Compounds. *Coordination Chem. Rev.* **2000**, *198*, 171-203.
- (33) Wasik, S. P.; Tsang, W. Gas Chromatographic Determination of Partition Coefficients of Some Unsaturated Hydrocarbons and Their Deuterated Isomers in Aqueous Silver Nitrate Solutions. *J. Phys. Chem.* **1970**, *74*, 2970-2976.
- (34) Bataafsche Petroleum. A Process for Separating Ketones from Mixtures Thereof with Other Compounds. GB Patent 730486, 1955.
- (35) Grasselli, J. O., Ed.; Atlas of Spectral Data and Physical Constants for Organic Compounds; CRC Press: Ohio, 1973.
- (36) Siggia, S.; Hanna, J. G. *Quantitative Organic Analysis via Functional Groups*; John Wiley & Sons: New York, 1979.
- (37) Critchfield, F. E. Organic Functional Group Analysis; Pergamon Press: Oxford, 1963.
- (38) Smith, M. B.; March, J. *March's Advanced Organic Chemistry. Chapter 10*, 5th ed.; John Wiley & Sons: New York, 2001.
- (39) Uozumi, Y.; Yasoshima, K.; Miyachi, T.; Nagai, S. Enantioselective Desymmetrization of Meso-Cyclic Anhydrides Catalysed by Hexahydro-1H-Pyrrolo[1,2-c]imidazones. *Tetrahedron Lett.* **2001**, *42*, 411-414.
- (40) Sabitha, G.; Srividya, R.; Yadav, J. S. Ring Opening of Cyclic Anhydrides: Synthesis of Achiral Half-Esters Using Lewis Acids. *Tetrahedron* **1999**, *55*, 4015-4018.
- (41) Maksimenko, E. G.; Kirilovich, V. I.; Lopatina, N. M.; Kutsenko, A. I.; Maksimova, G. V.; Zhuk, R. V.; Uskach, Ya. L.; Bogach, E. V.; Melnikov, M. D.; Kutyanin, L. I. Method of Obtaining Alkylbenzylphthalates. Russian Patent 1187420, 1994.
- (42) Ellington, J. B.; Brennecke, J. F. Pressure Effect on the Esterification of Phthalic Anhydride in Supercritical CO<sub>2</sub>. *J. Chem. Soc. Chem. Commun.* **1993**, 1094-1095.
- (43) Schwegler, M. A.; van Bekkum, H.; de Munck, N. A. Heteropolyacids as Catalysts for the Production of Phthalate Diesters. *Appl. Catal.* **1991**, *74*, 191-204.
- (44) Thorat, T. S.; Yadav, V. M.; Yadav, G. D. Esterification of Phthalic Anhydride with 2-Ethylhexanol by Solid Superacidic Catalysts. *Appl. Catal. A* **1992**, *90*, 73-96.
- (45) Skrzypek, J.; Zbigniew Sadlowski, J.; Lachowska, M.; Nowak, P. Kinetics of the Esterification of Phthalic Anhydride with 2-Ethylhexanol; Part IV: Non-Catalytic Process; Final Kinetics Comparison of the Catalysts. *Chem. Eng. Processing* **1998**, *37*, 163-167.

- (46) Grzesik, M.; Skrzypek, J.; Tuszyński, T. Esterification of Maleic Anhydride with 2-Ethylhexanol in Case When No Catalyst Is Used and In the Presence of Sulfuric Acid as a Catalyst. *Inżynieria Chemiczna I Procesowa* **1999**, *20*, 351-362.
- (47) Uozumi, Y. Laboratory of Complex Catalysis, Institute for Molecular Science, Okazaki, Japan, personal communication, 2001.
- (48) Ejlertsson, J.; Meyerson, U.; Svensson, B. H. Anaerobic Degradation of Phthalic Acid Esters During Digestion of Municipal Solid Waste Under Landfilling Conditions. *Biodegradation* **1996**, *7*, 345-352.
- (49) Bashkirov, A. N.; Grozhan, M. M.; Kamzolikin, V. V.; Lapitsky, J. A. Process for the Production of Aromatic Alcohols. GB Patent 1198233, 1970.
- (50) Okanagan University College. Programs/Departments. Science. Chemistry. Chemistry Faculty. Nigel Eggers. Chem 317. <http://www.people.ouc.bc.ca/neggers/Chem%20317/Course%20Notes/HYDROLYSIS.doc> (last accessed July 2002).
- (51) Suzuki, T.; Yaguchi, K.; Suzuki, S.; Suga, T. Monitoring of Phthalic Acid Monoesters in River Water by Solid-Phase Extraction and GC-MS Determination. *Environ. Sci. Technol.* **2001**, *35*, 3757-3763.
- (52) Andres, G. O.; Granados, A. M.; de Rossi, R. H. Kinetic Study of the Hydrolysis of Phthalic Anhydride and Aryl Hydrogen Phthalates. *J. Org. Chem.* **2001**, *66*, 7653-7657.
- (53) Krammer, P.; Vogel, H. Hydrolysis of Esters in Subcritical and Supercritical Water. *J. Supercrit. Fluids* **2000**, *16*, 189-206.
- (54) Tuulmets, A.; Raik, P. Ultrasonic Acceleration of Ester Hydrolysis. *Ultrason. Sonochemistry* **1999**, *6*, 85-87.
- (55) Cartwright, C. D.; Owen, S. A.; Thompson, I. P.; Burns, R. G. Biodegradation of Diethyl Phthalate in Soil by a Novel Pathway. *FEMS Microbiology Lett.* **2000**, *186*, 27-34.
- (56) Cox, A. Dicarboxylic and Polycarboxylic Acids. In *Comprehensive Organic Chemistry, Vol. 2, Nitrogen Compounds, Carboxylic Acids, Phosphorus Compounds*; Barton, S. D.; Ollis, W. D.; Sutherland, I. O., Eds.; Pergamon Press: Oxford, 1979.
- (57) Reid, R. C.; Prausnitz, J. M.; Poling, B. E. *The Properties of Gases & Liquids*; McGraw-Hill Book Company: Singapore, 1988.
- (58) Kortüm, G.; Vogel, W.; Andrussow, K. *Dissociation Constants of Organic Acids in Aqueous Solution*; Butterworths: London, 1961.
- (59) Ebersson, L. Acidity and Hydrogen Bonding of Carboxyl Groups. In *The Chemistry of Carboxylic Acids and Esters*; Patai, S., Ed.; Interscience Publishers: London, 1969.
- (60) Okada, T.; Hanaya, M.; Hattori, A.; Hamaji, H.; Miyake, T.; Tokumaru, S.; Nagira, N.; Ikumi, S.; Hori, T.; Mizui, N. Process for Producing Benzyl Acetate and Benzyl Alcohol. European Patent 0 778 257, 1997.
- (61) Ullmann, F. *Ullmann's Encyclopedia of Industrial Chemistry. Oxidations*, 6th ed.; Wiley-Interscience: New York, 2001.
- (62) Jonsson, S.; Boren, H. Analysis of Mono- and Diesters of o-Phthalic Acid by Solid-Phase Extractions with Polystyrene-Divinylbenzene-Based Polymers. *J. Chrom. A* **2002**, *963*, 393-400.
- (63) Regis Technologies. Chromatography. GC Derivatization Reagents. Derivatization Procedures. <http://www.registech.com/gc/procedures.pdf> (last accessed June 2003).
- (64) Alltech Associates Inc., Applied Science Labs *GC Derivatization Guide*; Alltech-Applied Science: Deerfield, 1986.
- (65) Wallas, S. M. *Chemical Reaction Engineering Handbook of Solved Problems*; Gordon and Breach: Amsterdam, 1995.
- (66) Kirk, R. E.; Othmer, D. F. *Kirk-Othmer Encyclopedia of Chemical Technology*; Wiley-Interscience: New York, 2003.

## Chapter 6

# Conceptual process design for recovery of toluene oxidation products

### 6.1 Introduction

Chapters 3-5 discussed the results of the conducted investigations on the reactive extraction of carbonyl compounds, carboxylic acids and alcohols. Based on that research, potential extraction-based processes for the recovery of benzyl alcohol (BA<sub>lc</sub>), benzaldehyde (BA<sub>ld</sub>) and benzoic acid (BA<sub>c</sub>) from the toluene oxidation reactor effluent are proposed and analysed on technical feasibility in this chapter. The most promising ones are also evaluated from the operational costs point of view.

The goal of the conducted research in this thesis was to evaluate whether aqueous salt solutions can be used as reactive extraction solvents for the recovery of carbonyl compounds, alcohols and acids from an apolar organic solvent. For that purpose, their capacity and selectivity were analysed, limiting the work to the characterisation of two-phase-systems at equilibrium. Determination of the kinetic and hydrodynamic parameters was beyond the scope of this thesis, but would eventually be the next step in the separation process development. As limited to the equilibrium data, no detailed process designs can be developed. Nevertheless, at this stage it is possible to propose and analyse processes at the conceptual level, defining the flowsheet as a sequence of operations with rough stream compositions and flowrates. Such designs will give insight of the type and number of sections required to achieve the desired recovery, and also an indication of the size of equipment. Hence, an initial comparison and selection between different options on a conceptual level can be performed.

One of the questions raised at the initial stage of this research was whether an extraction-based process could be more energy efficient than the distillation process. And if so, if that difference is sufficient to justify eventual investments in its application. Therefore, energy requirements of the proposed process are compared with a potential distillation-based process intended for the same recovery. That is done by determining heat duties and workloads of both processes and comparing the related utility (operational) costs. Although distillation-based processes for the recovery of oxygenates from the toluene oxidation mixture already exist (see Chapter 1), they are usually designed for different purposes. Benzoic acid is generally the main product of concern allowing a much higher conversion of toluene. Also, other oxygenates besides acid, alcohol and aldehyde are generated and have to

be separated. The distillation train was designed based on those requirements. Therefore, it wouldn't be adequate to do a comparison with such processes. Hence, a distillation-based process based on exactly the same design basis as used for the design of a reactive extraction process is used as a reference for comparison.

In addition to the analysis of possible process options, a preliminary evaluation whether the recovery of an oxygenate by the proposed reactive extraction solvents would be feasible in a typical extraction setup is presented in this chapter. For that purpose, benzaldehyde is extracted from toluene by an aqueous sodium hydrogen sulphite solution on pilot plant scale pulsed column with disc and doughnut internals.

## 6.2 Applicable options for reactive extraction and back-recovery

Among the analysed options for the extractive recovery of oxygenates, discussed in Chapters 3 to 5, several show sufficient potential to be applied. These extractants and the associated back-recovery alternatives are listed in Table 6.1.

**Table 6.1** Applicable extractants with adequate back-recovery options for recovery of oxygenates.

| Extractant  | Oxygenate               | Back-recovery   | Reference              |
|---|-------------------------|---|------------------------|
| AgNO <sub>3</sub>                                     | Benzyl alcohol          | Back-extraction with temperature shift  | Chapter 5              |
| Hydroxypropyl- $\alpha$ - or - $\beta$ -cyclodextrins | Benzyl alcohol          | Back-extraction with temperature shift  | Chapter 5              |
| NaHCO <sub>3</sub>                                    | Modified benzyl alcohol | Back-extraction with temperature shift  | Chapter 5              |
|   | Benzoic acid            | Precipitation induced by CO <sub>2</sub><br>CO <sub>2</sub> aided back-extraction | Chapter 4<br>Chapter 4 |
| NaHSO <sub>3</sub>                                    | Benzaldehyde            | Back-extraction with temperature shift  | Chapter 3              |
| Amine salts   | Benzaldehyde            | Back-extraction with temperature shift  | Chapter 3              |

Extraction using an aqueous solution of silver nitrate or hydroxypropyl-cyclodextrin are potential options for the recovery of benzyl alcohol. The other evaluated extractants for that recovery showed no potential to be used. The effect of temperature on the complexation with AgNO<sub>3</sub> or hydroxypropyl-cyclodextrin has to be confirmed experimentally. However, based on literature which states the exothermic nature of these reactions,<sup>1-5</sup> back-extraction with a temperature shift is adopted as option for the back-recovery of benzyl alcohol. Furthermore, by first modifying the alcohol into a monoester of phthalic or 3-methylglutaric acid, using phthalic or 3-methylglutaric anhydride, an aqueous solution of sodium hydrogen carbonate can be used to extract the modified alcohol. In that case, the back-recovery is done by back-extraction with a temperature shift. Since the monoester of benzyl alcohol with hexahydrophthalic anhydride is not extractable with sodium hydrogen carbonate, it is not included in the following consideration.

Reactive extraction using a solution of NaHCO<sub>3</sub> with subsequent back-recovery by a carbon dioxide induced precipitation of the acid or by a carbon dioxide aided back-extraction, are the applicable alternatives for the recovery of benzoic acid.

Finally, benzaldehyde can be extracted using an aqueous solution of sodium hydrogen sulphite or an amine salt, with a back-recovery at a temperature higher than that of the forward-extraction. Hydrazines are not included as extractants for benzaldehyde, since they did not show sufficient potential to apply a temperature shift for the back-recovery. It should be emphasised that this is not the case for the other evaluated carbonyl compounds, for which even hydrazines may be feasible.

For the back-recovery of the extracted benzyl alcohol and benzaldehyde only back-extraction with a temperature shift is considered since it is the only option experimentally evaluated. However, as mentioned in the previous chapters, it may be possible to apply the temperature shift in combination with a formation of a new, oxygenate-rich phase (similar as for back-recovery of benzoic acid by precipitation, but instead of using carbon dioxide under pressure, a temperature shift is applied). Nevertheless, since this option is not experimentally evaluated, it will not be included as an option for a process design in present analysis.

### 6.3 Product recovery by reactive extraction from a single solute solution

The options summarised in Table 6.1 directly lead to the potential process conceptual flowsheets for the recovery of each product from a single solute solution. These are presented in Figures 6.1 - 6.3. Each box of the flowsheet represents one unit operation that can either be one multistage unit or a few single-stage units. The stream compositions are given assuming a 100% efficiency in each unit operation. Since all involved reactions (extractive reactions, but also monoesterification in the recovery of benzyl alcohol) are reversible, an excess of reactant is taken in each case. In all conceptual flowsheets that will follow, the stream compositions are qualitative, i.e. a list of compounds present in each of them is given. However, in Appendix A2 a case study is presented in which the stream compositions are quantified for two reactive extraction-based processes (selected later in this chapter as the optimal cases).

In all analysed cases, toluene is used as the back-extraction solvent because of available experimental data. However, any other apolar solvent could be applied, providing it is efficient.

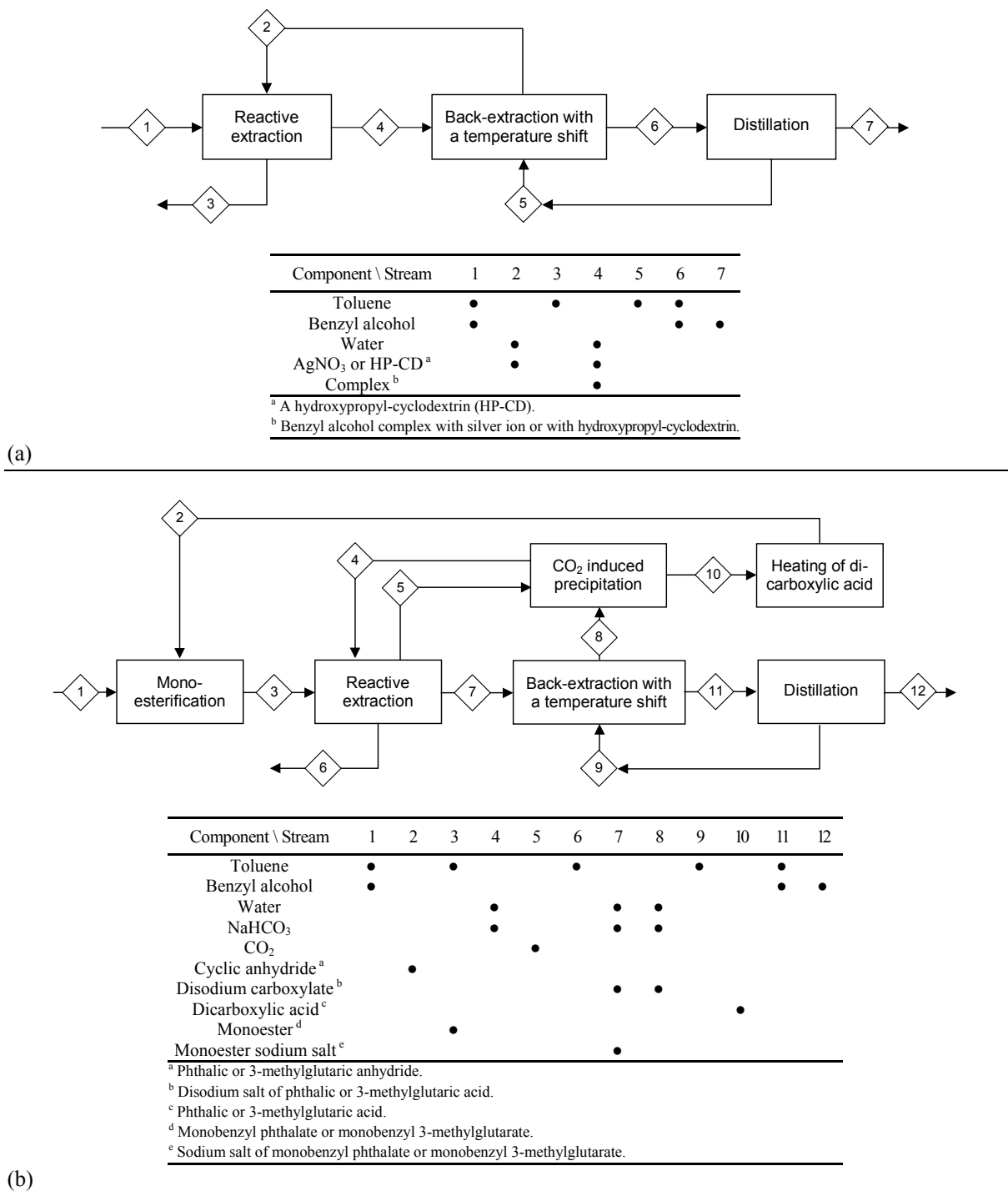
#### 6.3.1 Recovery of benzyl alcohol

Figure 6.1 shows the two options for the recovery of benzyl alcohol.

The advantage of Flowsheet I over Flowsheet II, concerning the number of sections, is obvious. However, as already discussed in Chapter 5, both the forward- and back-extraction in Flowsheet II require much less equilibrium stages than those in Flowsheet I for the same recovery. Furthermore, the monoesterification section can be integrated in the oxidation reactor and therefore allows a simplification of Flowsheet II. Hence, the decision which flowsheet is more favourable depends on the specific process requirements and limitations.

#### 6.3.2 Recovery of benzoic acid

For the recovery of benzoic acid two conceptual flowsheets are proposed (see Figure 6.2). Both include the same dissociation extraction section, but differ in the back-recovery. The first proposes back-recovery by precipitation and the second one by back-extraction.



**Figure 6.1** Conceptual process flowsheets for the recovery of (a) unmodified benzyl alcohol [Flowsheet I] and (b) benzyl alcohol modified into a monoester [Flowsheet II].

Since similar recoveries can be achieved by both options (see Chapter 4), the selection of the optimal conceptual flowsheet for the recovery of benzoic acid should be based on the choice between operation with solids at high pressure versus back-extraction and distillation.



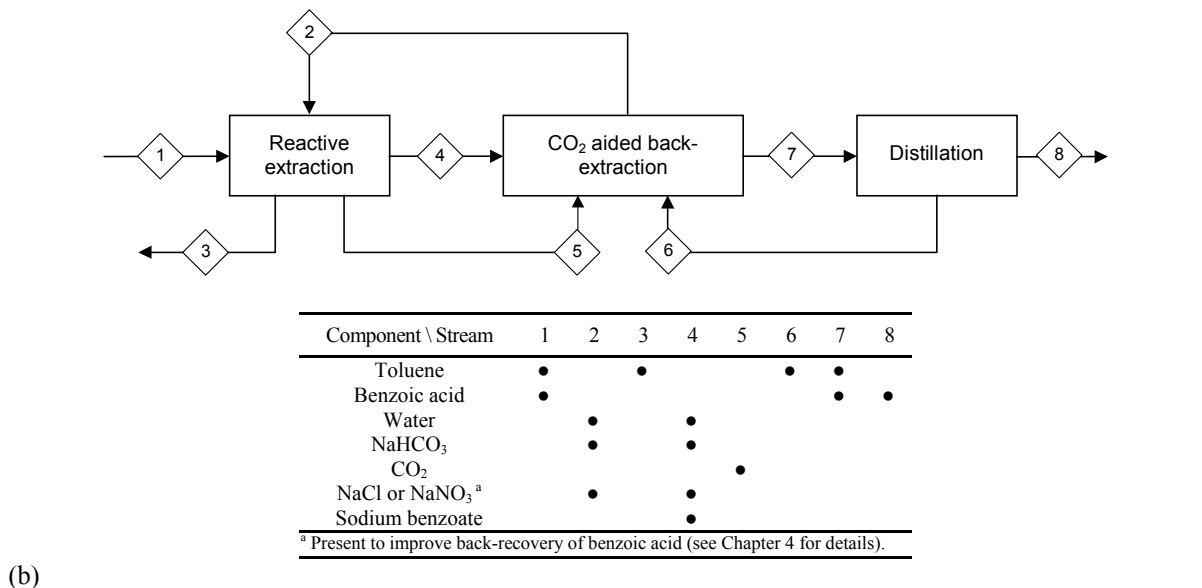
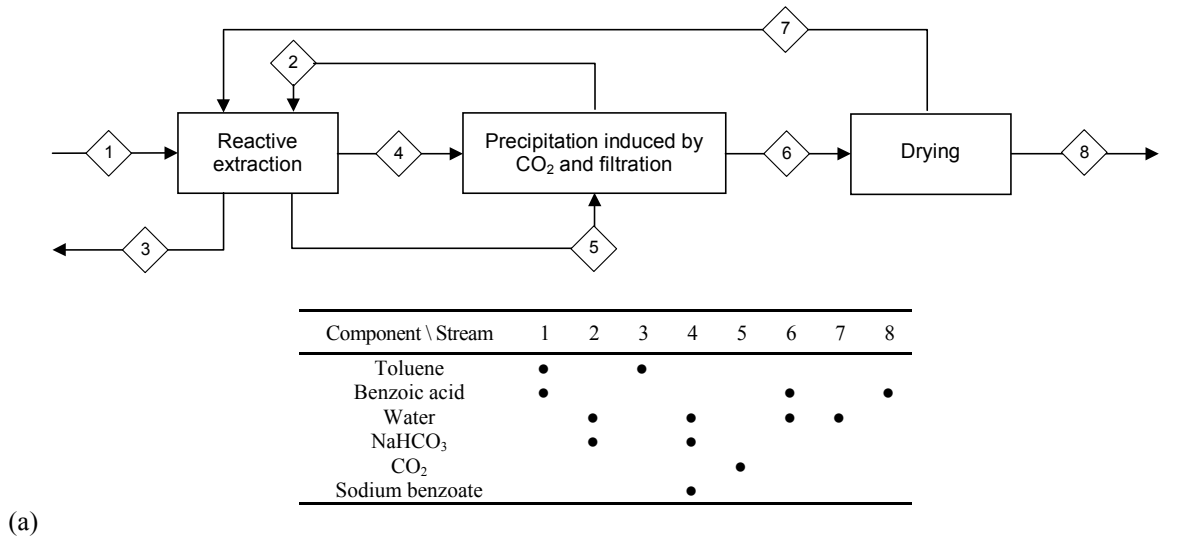


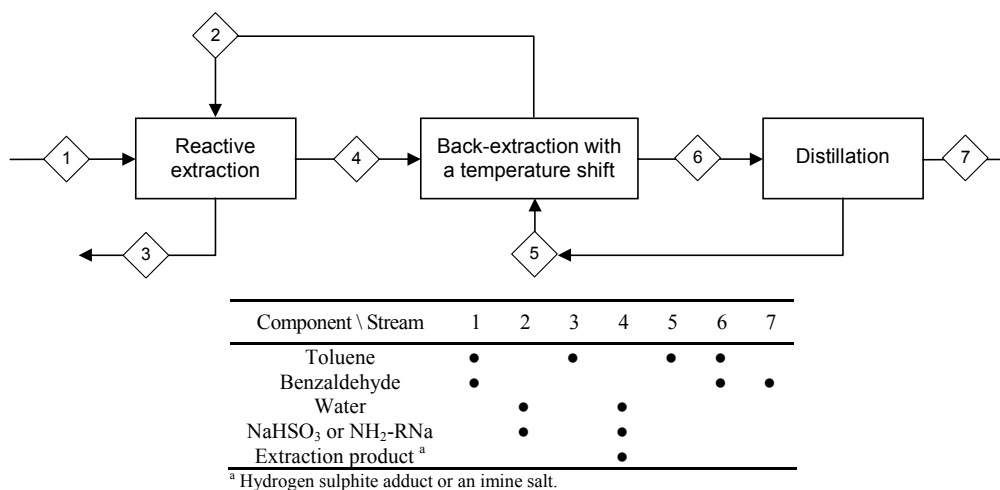
Figure 6.2 Conceptual process flowsheets for the recovery of benzoic acid with back-recovery by (a) CO<sub>2</sub> induced precipitation [Flowsheet III] and (b) CO<sub>2</sub> aided back-extraction [Flowsheet IV].

### 6.3.3 Recovery of benzaldehyde

The only difference between the two options for the recovery of benzaldehyde shown in Table 6.1 is the type of extractant. Therefore, a single conceptual flowsheet, presented in Figure 6.3, is applicable for both options.

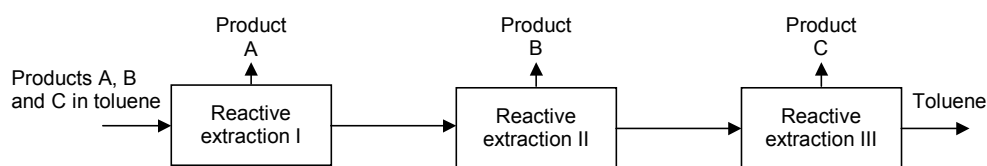
## 6.4 Product recovery by reactive extraction from multicomponent solution

The flowsheets in Figures 6.1 - 6.3 are aimed for the recovery of an oxygenate from a single-solute toluene solution. However, the primary task is to design a process for the product recovery when all three products are present in toluene, i.e. from a multicomponent solution. This will be done by combining Flowsheets I to V and eventually integrating process sections, in order to determine the feasible option which requires the least number of sections.

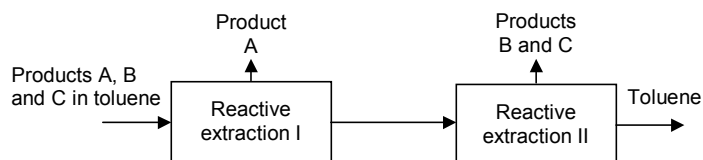
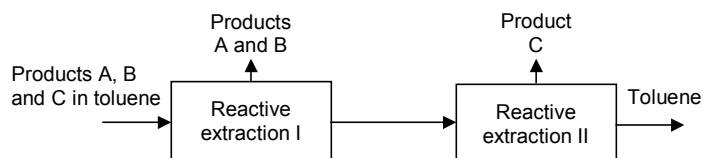


**Figure 6.3** Conceptual process flowsheet for the recovery of benzaldehyde [Flowsheet V].

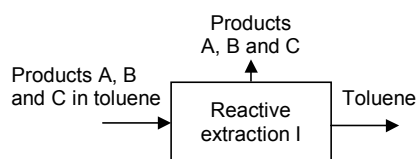
Theoretically, three types of such a process can be designed. The products can be extracted either in one (type C), in two (type B) or in three consecutive reactive extraction sections (type A in Figure 6.4). Although, at first sight, type C may seem the most attractive configuration due to the least number of extraction sections, still none of the options should be overruled before analysing the total process, including the back-recovery of the extracted products. Therefore, all consequences of the partial and full integration of the reactive extraction sections have to be explored and evaluated.



**Type A**



**Type B**



**Type C**

**Figure 6.4** Recovery of products in three (Type A), two (Type B) or one (Type C) reactive extraction section.

For type A and type B processes, the arrangement in which the forward extractions are performed may vary. However, following the below-stated sequencing criteria the number of options can be reduced such that only optimal cases will remain:

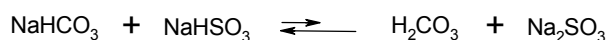
- The products should be recovered in the order of decreasing physical distribution ratio between pure water and toluene, i.e. first benzyl alcohol, then benzoic acid and finally benzaldehyde. In this way the loss of a product in the extraction section through which it is just passing through will be minimal;
- If an amine salt is used for the extraction of benzaldehyde, then benzoic acid must be recovered prior to the aldehyde (see Section 6.4.1);
- The extraction of a monoesterified alcohol can not be used in Type A processes, but only in those of Type B that integrate the extraction of benzoic acid and benzyl alcohol; Therefore, in Type A processes the extraction of benzyl alcohol by  $\text{AgNO}_3$  or hydroxypropyl-cyclodextrins is the only possibility.

#### 6.4.1 Integrated reactive extraction of toluene oxidation products

Integration to the Type C configuration requires a mixture of extractants since none of the extractants is capable of extracting all three products (at least, this is not evaluated experimentally for the simultaneous extraction of all three products). The same holds for Type B processes, except when  $\text{NaHCO}_3$  is used for the extraction of both benzoic acid and modified benzyl alcohol. All possible combinations for each level of integration are given in Sections 6.4.3 and 6.4.4 (Figure 6.7 and Table 6.2), where Type B and C processes are discussed.

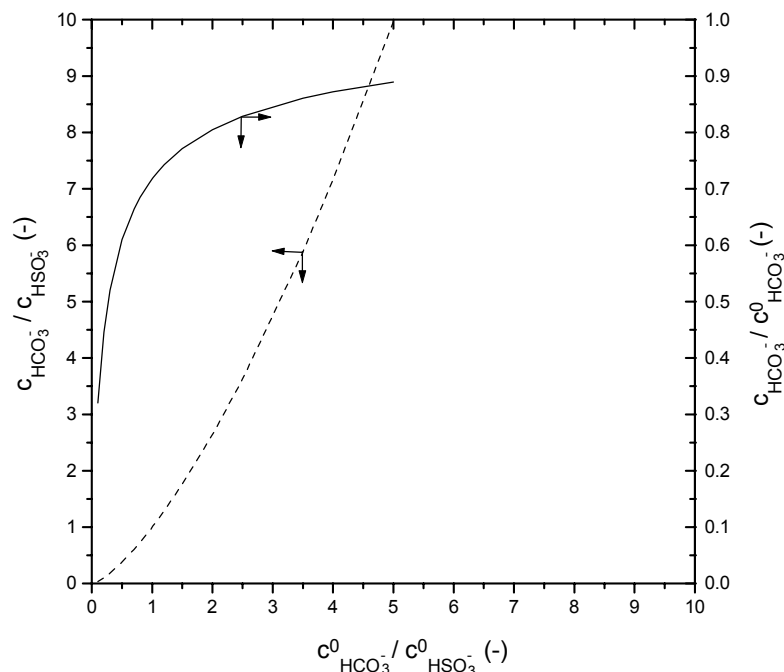
Which combinations of extractants are indeed practically applicable should be determined considering a potential interaction of the extractants with each other, the effect of each extractant on each solute and the effect on the back-recovery operations. All these effects have to be analysed and verified experimentally. However, for the purpose of analysing advantages and disadvantages of Type B and C processes, a rough theoretical consideration concerning the coexistence of two or more extractants in one solution and the possible effects of one extractant on the other products than that which it extracts, is done.

If both  $\text{NaHCO}_3$  and  $\text{NaHSO}_3$  are introduced in the same solution (this combination can provide the integrated extraction of acid and aldehyde, but also of the alcohol if it is modified into monoester), the equilibrium shown in Scheme 6.1 will be established.



**Scheme 6.1** Salt equilibrium in an aqueous solution of  $\text{NaHCO}_3$  and  $\text{NaHSO}_3$ .

Some hydrogen carbonate will be converted into carbonic acid, and some hydrogen sulphite in  $\text{SO}_3^{2-}$ . To evaluate extent of this conversion, which causes a loss of extractants, the actual salt concentration ratio  $[c_{\text{HCO}_3^-} / c_{\text{HSO}_3^-}]$  and the conversion, i.e. the ratio of the actual and the initial hydrogen carbonate concentration  $[c_{\text{HCO}_3^-} / c_{\text{HCO}_3^-}^0]$  are calculated as a function of the ratio of their initial concentrations (see Figure 6.5) [the calculation is based on the dissociation constants of carbonic acid ( $\text{H}_2\text{CO}_3$ ) and hydrogen sulphite ( $\text{HSO}_3^-$ )]. The results show that the loss depends on the initial salt ratio, but that still these two salts can coexist in one single solution in any required concentration providing adequate initial concentrations.



**Figure 6.5** Calculated equilibrium concentration ratio ( $c_{\text{HCO}_3^-}/c_{\text{HSO}_3^-}$ ) and loss of hydrogen carbonate ( $c_{\text{HCO}_3^-}/c_{\text{HCO}_3^0}$ ) vs. the ratio of introduced concentrations of NaHSO<sub>3</sub> and NaHCO<sub>3</sub> ( $c_{\text{HCO}_3^0}/c_{\text{HSO}_3^0}$ ).

It is shown that both silver nitrate and hydroxypropyl-cyclodextrins interact with benzyl alcohol, but also with toluene (Chapter 5). Since obviously their interaction is based on the existence of an aromatic ring, it is very likely that they will interact also with the other two oxygenates - benzoic acid and benzaldehyde. The existence and order of magnitude of these interactions can be estimated, but should preferably be evaluated experimentally. However, for further analysis of the integrated options in this work, the interaction of silver nitrate or hydroxypropyl-cyclodextrins with benzoic acid and benzaldehyde is neglected.

Amine salts, found to react with benzaldehyde, will also extract benzoic acid due to their basic properties. However, back recovery of such salts would require the introduction of strong bases and that is not acceptable if the process is supposed to avoid dangerous chemicals. Therefore, amine salts can only be used for joined extraction once benzoic acid has been already recovered.

The positive effect of a salting-out agent (NaCl or NaNO<sub>3</sub>) on the back-recovery of benzoic acid was discussed in Chapter 4. However, the effect of these salts on all other sections in any integrated process was not experimentally explored. For this analysis, it is assumed that there is no effect of such agent on any other operation, except the back-recovery of benzoic acid.

### 6.4.2 Type A processes

Following the sequencing criteria defined earlier, the optimal sequence of the Type A process will consist of Flowsheet I (recovery of the alcohol), Flowsheet III or IV (recovery of the acid), and Flowsheet V (recovery of the aldehyde), in that order. The overall flowsheet of such process if Flowsheet III is used for the recovery of benzoic acid is given in Figure 6.6.

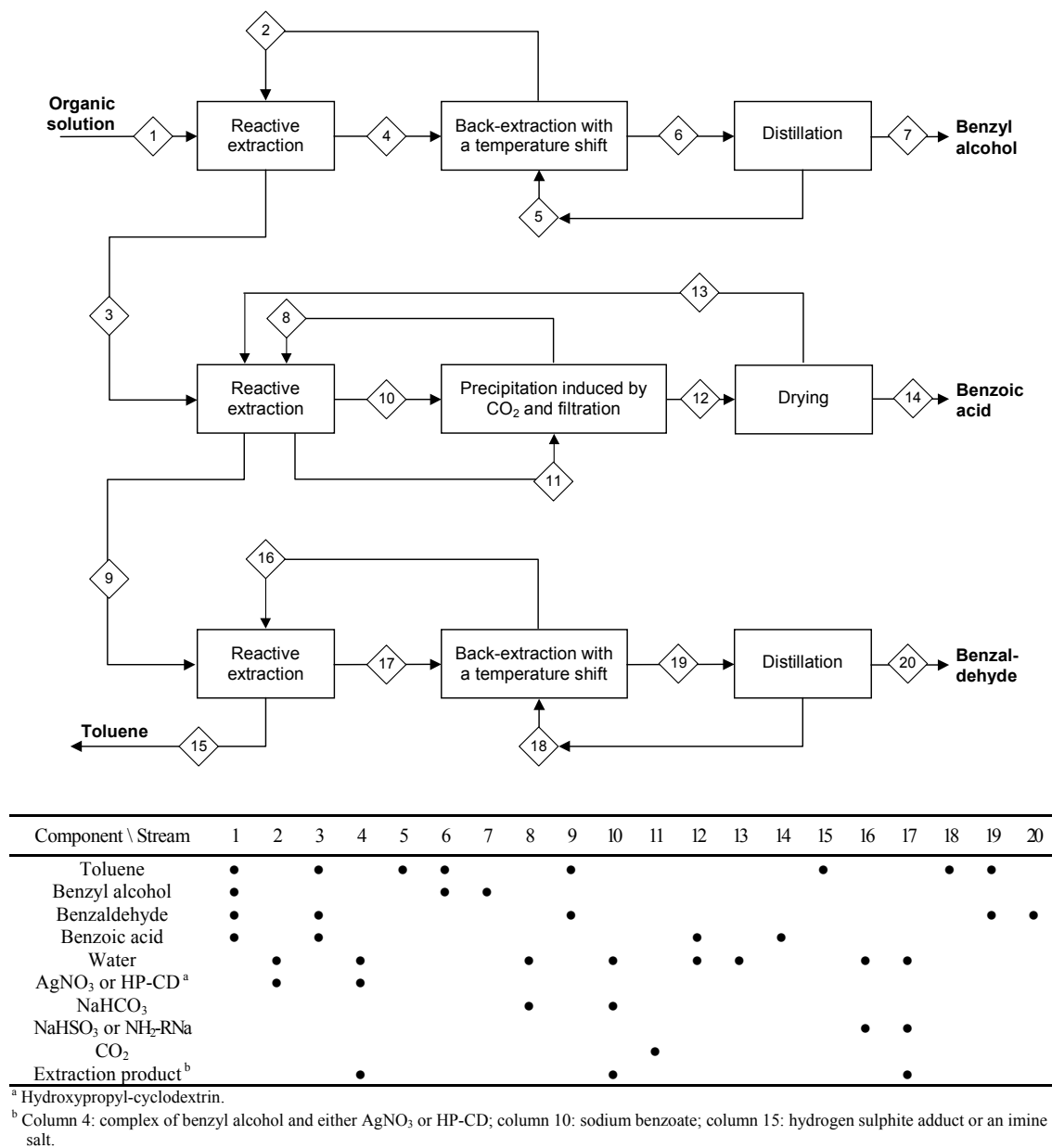


Figure 6.6 Conceptual flowsheet of Type A process (combination of the Flowsheets I, III and V).

Further optimisation of this process should be done by selecting better option between Flowsheets III and IV, and by determining which of the extractants, AgNO<sub>3</sub> or hydroxypropyl-cyclodextrin for benzyl alcohol, and NaHSO<sub>3</sub> or an amine salt for benzaldehyde, is more suitable for the specific process requirements (required recovery of the product, operational and equipment costs, etc.).

It should be mentioned that the two back-extraction sections in the conceptual flowsheet of Figure 6.6 are not integrated despite the same function they have. If integrated, one back-extraction section will be eliminated, but then the recovery of both extractants from water and their separation after back-extraction would have to be added instead. This is not considered as advantageous and hence the two back-recovery sections in both, but also later in the Type B processes, are kept separated.

### 6.4.3 Type B process

Again, based on the introduced sequencing criteria, three sequences appear as the most promising options for a Type B process (see Figure 6.7). Possible combinations of extractants are listed for each case.

| Sequence   | Product(s) / Extractant(s)              | Product(s) / Extractant(s)              |
|------------|---|---|
|            |   |   |
| Sequence A | BAIc                                    | BAId<br>BAc                             |
| Option 1   | AgNO <sub>3</sub>                       | NaHCO <sub>3</sub> + NaHSO <sub>3</sub> |
| Option 2   | HP-CD <sup>a</sup>                      | NaHCO <sub>3</sub> + NaHSO <sub>3</sub> |
| Sequence B | BAIc<br>BAc                             | BAId                                    |
| Option 1   | AgNO <sub>3</sub> + NaHCO <sub>3</sub>  | NaHSO <sub>3</sub>                      |
| Option 2   | HP-CD <sup>a</sup> + NaHCO <sub>3</sub> | NaHSO <sub>3</sub>                      |
| Option 3   | NaHCO <sub>3</sub> <sup>b</sup>         | NaHSO <sub>3</sub>                      |
| Option 4   | AgNO <sub>3</sub> + NaHCO <sub>3</sub>  | NH <sub>2</sub> -RNa                    |
| Option 5   | HP-CD <sup>a</sup> + NaHCO <sub>3</sub> | NH <sub>2</sub> -RNa                    |
| Option 6   | NaHCO <sub>3</sub> <sup>b</sup>         | NH <sub>2</sub> -RNa                    |
| Sequence C | BAIc<br>BAId                            | BAc                                     |
| Option 1   | AgNO <sub>3</sub> + NaHSO <sub>3</sub>  | NaHCO <sub>3</sub>                      |
| Option 2   | HP-CD <sup>a</sup> + NaHSO <sub>3</sub> | NaHCO <sub>3</sub>                      |

<sup>a</sup> A hydroxypropyl-cyclodextrin (HP-CD).  
<sup>b</sup> When alcohol is modified into a monoester.

**Figure 6.7** The most promising sequences for recovery of three products in two reactive extraction sections (Type B process).

For all options of Sequence A, and all, except 3 and 6, of Sequence B, the flowsheet of the process is an exact combination of the Flowsheets I, V and either III or IV, but with integrated extraction sections of benzaldehyde and benzyl alcohol. There is no integration of any other section, or need for any additional section. As an illustration, the recovery process according to Sequence A is shown in Figure 6.8, using Flowsheet III for the recovery of benzoic acid.

The arrangement of the back-recovery sections after the joint extraction is determined in such a way that the product losses are minimal. Concretely, if precipitation is applied for back-recovery of benzoic acid (Flowsheet III), this back-recovery should be done prior to the recovery of benzaldehyde and benzyl alcohol by back-extraction. If not, a certain amount of acid would be back-extracted in toluene together with the alcohol and aldehyde. On the other hand, by using back-extraction for the back-recovery of benzoic acid (Flowsheet IV), some losses of a product prior to its back-recovery will occur, but the arrangement of the back-extractions has to be such that these are minimal. Decomplexation of the extracted benzyl alcohol and benzaldehyde requires an increase of temperature. Hence, back-extraction of benzoic acid, which is performed at low temperatures, should be done first, and then the back-extraction of other products.

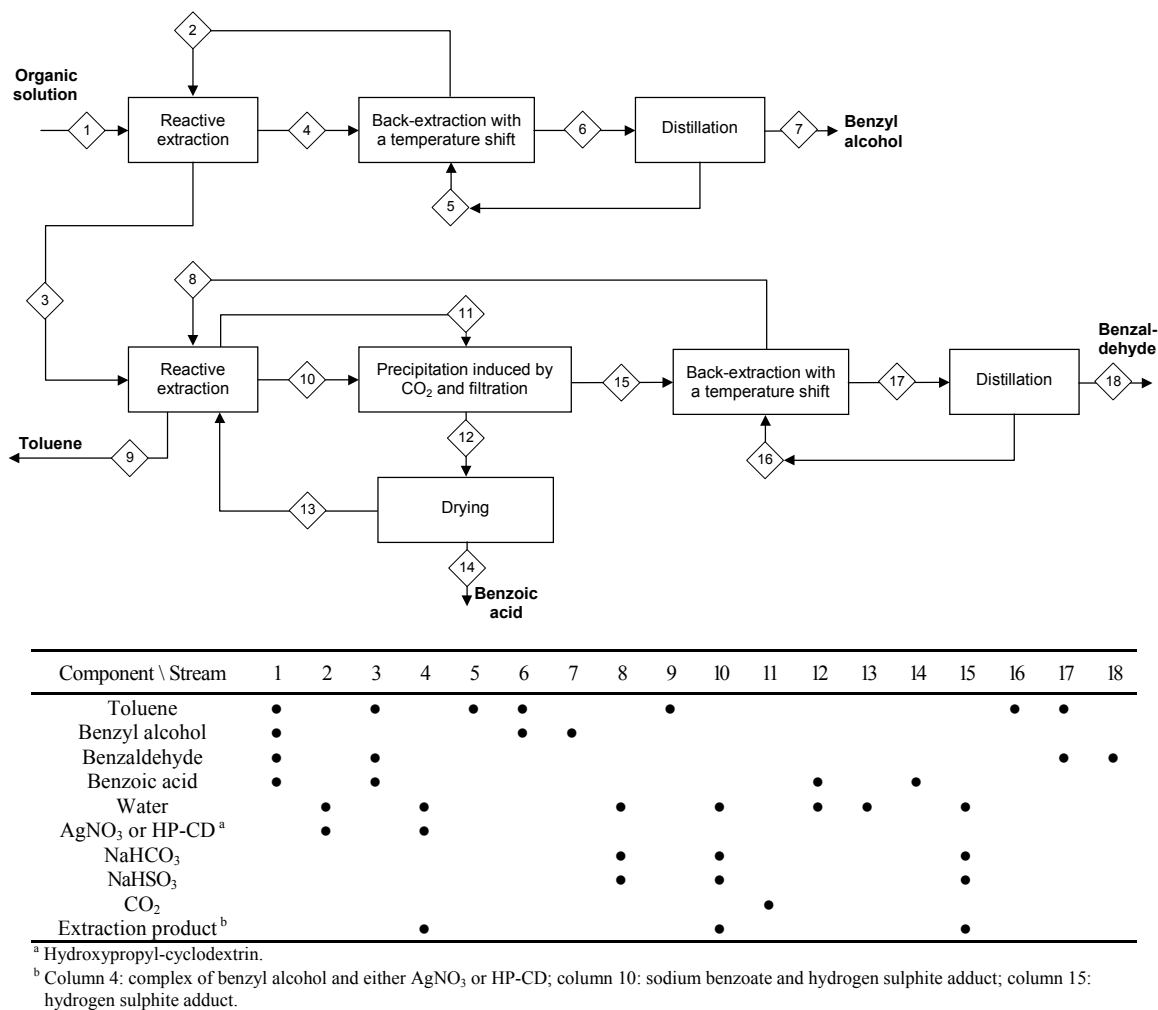


Figure 6.8 Conceptual flowsheet of Type B process having Sequence A (combination of Flowsheets I, III and V).

For options 3 and 6 of Sequence B and 1 and 2 of Sequence C, the consequence of the common extraction is the integration of some of the back-recovery sections. For these options of Sequence B, combination of the Flowsheets II, III and V is needed. The two extraction sections, but also the precipitation sections will be joined. However, such integration asks for the introduction of an additional solids separation section (see Figure 6.10 where a similar integration is shown). Flowsheet IV, i.e. back-recovery of benzoic acid by back-extraction, is not included as an option in this case. This is done because back-recovery of dicarboxylic acid in Flowsheet II is already achieved by precipitation, and therefore the same is adopted for benzoic acid back-recovery. The combination of back-recovery of benzoic acid by back-extraction as in Flowsheet V and of dicarboxylic acid by precipitation in the same equipment could be possible, but it is considered to be very demanding operation and therefore it is excluded.

The integration of the back-extraction sections is a consequence of the joint forward-extractions in all Sequence C options (see Figure 6.9 where the same is done). This does not eliminate the need for two distillation sections, but only changes the components that are separated in these sections. Instead of separating each product from toluene, the first distillation separates both products from toluene, followed in the second one by the separation of the two products. This is also beneficial because the flowrate to the second distillation section is lower, reducing the equipment size and asking for less energy for

distillation. In that case the overall conceptual flowsheet is again a combination of the Flowsheets I, V and either III or IV.

#### 6.4.4 Type C process

The joint extraction of all three oxidation products in a single extraction section (Type C process) can be done using the three different mixtures of extractants as shown in Table 6.2.

**Table 6.2** Extractants for recovery of all three products in one reactive extraction section.

| Option | Extractants   |
|--------|---|
| 1      | $\text{AgNO}_3 + \text{NaHSO}_3 + \text{NaHCO}_3$           |
| 2      | $\text{HP-CD}^{\text{a}} + \text{NaHSO}_3 + \text{NaHCO}_3$ |
| 3      | $\text{NaHSO}_3 + \text{NaHCO}_3^{\text{b}}$                |

<sup>a</sup> A hydroxypropyl-cyclodextrin (HP-CD).  
<sup>b</sup> When alcohol is modified into a monoester.

For the recovery using the first two options of Table 6.2, the overall conceptual flowsheet is a combination of Flowsheets I, V and either III or IV, where all three extraction sections are integrated. The consequence is the same as discussed for the Sequence C configuration of a Type B process: the two back-extraction sections for the back-recovery of benzyl alcohol and benzaldehyde are joined, causing a change in components that are separated in each of the two distillation sections (see Figure 6.9).

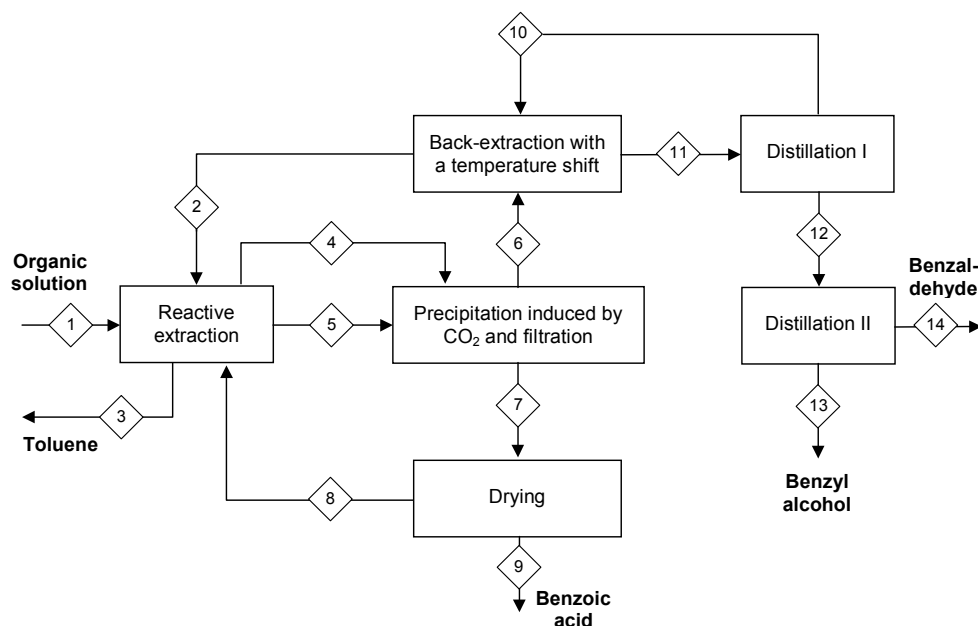
The third option of Table 6.2 requires an overall conceptual flowsheet that is a combination of Flowsheets II, V and III (as already discussed for the similar Type B processes, Flowsheet IV is not an option in this case). Again, the consequence of the integration of all forward-extractions is that the back-extractions of both benzyl alcohol and benzaldehyde have to be performed in one section. As already mentioned, that causes a change in components that are separated in each of the two distillation sections. Another consequence of this full integration is the fusion of the precipitations of both benzoic and dicarboxylic acid. That integration requires introduction of an additional section in which solid benzoic and solid dicarboxylic acid have to be separated. Although solids, this separation can be done as a liquid-solid separation if performed above the melting point of the lower melting acid. The conceptual flowsheet of this process is given in Figure 6.10.

The arrangement of the back-recovery sections in the conceptual Flowsheet shown in Figure 6.9 is determined in the same way as for Type B processes. However, for the flowsheet shown in Figure 6.10, an exception is made because the back-extraction is done prior to precipitation. The reason is the necessity to hydrolyse the monoester prior to precipitation of the dicarboxylic acid. However, if benzoic acid would be back-recovered by back-extraction, then the same rules as for Type B processes have to be followed. In that case, it is possible to recover the dicarboxylic acid after hydrolysis of the monoester.

#### 6.4.5 Optimal process type

Based on the above analysis of all three process types, it can be concluded that each Type C process requires one section less than a Type B process if both are composed from the same elementary conceptual flowsheets. On the other hand, there are no complications foreseen when joining the two extraction sections, as in Type B, into a single section as in a process of Type C. Therefore, it can be concluded that a Type C process is generally more promising than a Type B.





| Component \ Stream                      | 1 | 2              | 3 | 4 | 5 | 6 | 7 | 8 | 9 | 10 | 11 | 12 | 13 | 14 |
|---|---|----------------|---|---|---|---|---|---|---|----|----|----|----|----|
| Toluene                                 | • |                | • |   |   |   |   |   |   | •  | •  |    |    |    |
| Benzyl alcohol                          | • |                |   |   |   |   |   |   |   |    | •  | •  | •  |    |
| Benzaldehyde                            | • |                |   |   |   |   |   |   |   |    | •  | •  |    | •  |
| Benzoic acid                            | • |                |   |   |   |   | • |   | • |    |    |    |    |    |
| Water                                   |   | •              |   |   | • | • | • | • |   |    |    |    |    |    |
| AgNO <sub>3</sub> or HP-CD <sup>a</sup> |   | •              |   |   | • | • |   |   |   |    |    |    |    |    |
| NaHCO <sub>3</sub>                      |   | •              |   |   | • | • |   |   |   |    |    |    |    |    |
| NaHSO <sub>3</sub>                      |   | •              |   |   | • | • |   |   |   |    |    |    |    |    |
| Na <sub>2</sub> SO <sub>3</sub>         |   | • <sup>b</sup> |   |   | • | • |   |   |   |    |    |    |    |    |
| CO <sub>2</sub>                         |   | • <sup>b</sup> |   | • | • | • |   |   |   |    |    |    |    |    |
| NaCl or NaNO <sub>3</sub> <sup>c</sup>  |   | •              |   |   | • | • |   |   |   |    |    |    |    |    |
| Complexed alcohol <sup>d</sup>          |   |                |   |   | • | • |   |   |   |    |    |    |    |    |
| Hydrogen sulphite adduct                |   |                |   |   | • | • |   |   |   |    |    |    |    |    |
| Sodium benzoate                         |   |                |   |   | • |   |   |   |   |    |    |    |    |    |

<sup>a</sup> Hydroxypropyl-cyclodextrin.

<sup>b</sup> As discussed before, introduction of both NaHSO<sub>3</sub> and NaHCO<sub>3</sub> will generate some Na<sub>2</sub>SO<sub>3</sub> and CO<sub>2</sub>.

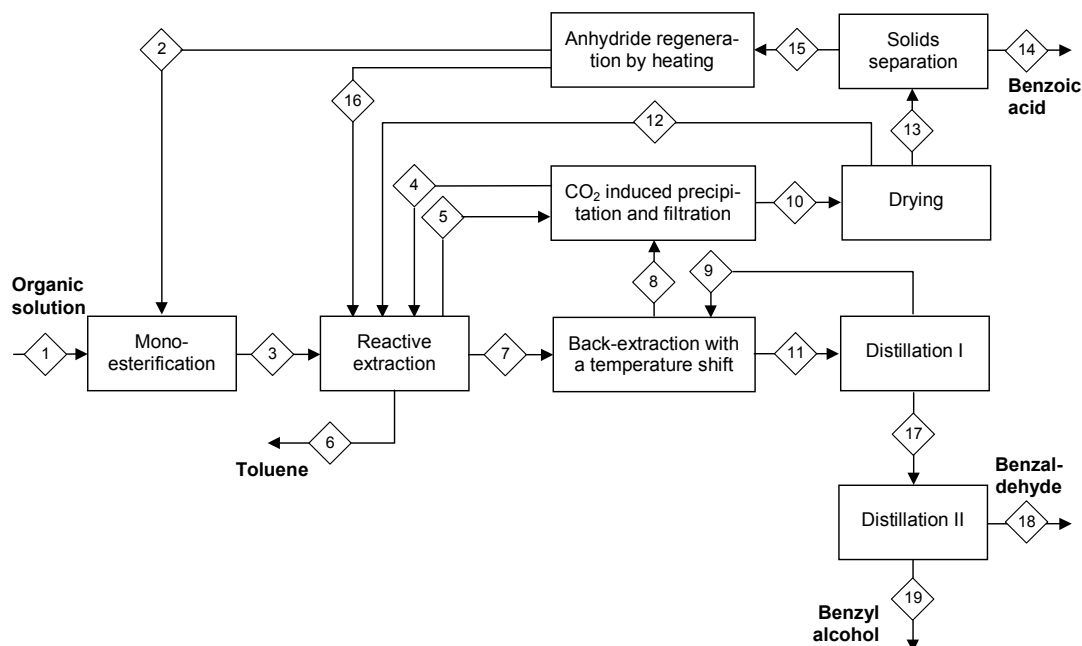
<sup>c</sup> Present to improve the back-recovery of benzoic acid (see Chapter 4 for details).

<sup>d</sup> Complex of benzyl alcohol and either silver nitrate or hydroxypropyl-cyclodextrin.

**Figure 6.9** Conceptual flowsheet of reactive extraction-based process in which all three products are extracted in the same section (Type C process). Alcohol is extracted unmodified, whereas benzoic acid is back-recovered by precipitation (options 1 and 2).

The same can be said after comparing a Type B with a Type A process. However, at the conceptual design level when only sections (unit operations) are counted, but their size and operational requirements are still not known, this comparison can only be made for the Type B processes which are built as a combination of Flowsheets I, V and III or IV, since the same combination appears in the optimal Type A process. Although the number of sections increases by the involvement of Flowsheet II, it still offers a more efficient extraction and back-extraction (the same discussion applies here as already presented in Section 6.3.1 where Flowsheets I and II are compared).

Figure 6.11 compares the various proposed process types by counting the number of sections (unit operations), based on a classification in two directly comparable groups: those which use elementary Flowsheets I, V and III or IV, and those with Flowsheets II, III and V.



| Component \ Stream                     | 1 | 2 | 3 | 4              | 5 | 6 | 7 | 8 | 9 | 10 | 11 | 12 | 13 | 14 | 15 | 16 | 17 | 18 | 19 |   |
|--|---|---|---|----------------|---|---|---|---|---|----|----|----|----|----|----|----|----|----|----|---|
| Toluene                                | • |   | • |                |   | • |   |   | • |    | •  |    |    |    |    |    |    |    |    |   |
| Benzyl alcohol                         | • |   |   |                |   |   |   |   |   |    | •  |    |    |    |    |    |    | •  |    | • |
| Benzaldehyde                           | • |   |   |                |   |   |   |   |   |    | •  |    |    |    |    |    |    | •  |    |   |
| Benzoic acid                           | • |   | • |                |   |   |   |   |   | •  |    |    | •  | •  |    |    |    |    |    | • |
| Water                                  |   |   |   | •              |   |   | • | • |   | •  |    | •  |    |    |    |    | •  |    |    |   |
| NaHCO <sub>3</sub>                     |   |   |   | •              |   |   | • | • |   |    |    |    |    |    |    |    |    |    |    |   |
| NaHSO <sub>3</sub>                     |   |   |   | •              |   |   | • | • |   |    |    |    |    |    |    |    |    |    |    |   |
| Na <sub>2</sub> SO <sub>3</sub>        |   |   |   | • <sup>e</sup> |   |   | • | • |   |    |    |    |    |    |    |    |    |    |    |   |
| CO <sub>2</sub>                        |   |   |   | • <sup>e</sup> | • |   | • | • |   |    |    |    |    |    |    |    |    |    |    |   |
| NaCl or NaNO <sub>3</sub> <sup>a</sup> |   |   |   | •              |   |   | • | • |   |    |    |    |    |    |    |    |    |    |    |   |
| Hydrogen sulphite adduct               |   |   |   |                |   |   | • |   |   |    |    |    |    |    |    |    |    |    |    |   |
| Sodium benzoate                        |   |   |   |                |   |   | • | • |   |    |    |    |    |    |    |    |    |    |    |   |
| Cyclic anhydride <sup>b</sup>          |   | • | • |                |   |   |   |   |   |    |    |    |    |    |    |    |    |    |    |   |
| Disodium carboxylate <sup>c</sup>      |   |   |   |                |   |   | • | • |   |    |    |    |    |    |    |    |    |    |    |   |
| Dicarboxylic acid <sup>d</sup>         |   |   |   |                |   |   |   |   |   |    |    |    |    | •  |    |    |    |    |    |   |
| Monoester <sup>e</sup>                 |   |   | • |                |   |   |   |   |   | •  |    |    |    | •  |    |    | •  |    |    |   |
| Monoester sodium salt <sup>f</sup>     |   |   |   |                |   |   | • |   |   |    |    |    |    |    |    |    |    |    |    |   |

<sup>a</sup> Present to improve the back-recovery of benzoic acid.

<sup>b</sup> Phthalic or 3-methylglutaric anhydride.

<sup>c</sup> Disodium salt of phthalic or 3-methylglutaric acid.

<sup>d</sup> Phthalic or 3-methylglutaric acid.

<sup>e</sup> Monobenzyl phthalate or monobenzyl 3-methylglutarate.

<sup>f</sup> Sodium salt of monobenzyl phthalate or monobenzyl 3-methylglutarate.

<sup>g</sup> As discussed before, introduction of both NaHSO<sub>3</sub> and NaHCO<sub>3</sub> will generate some Na<sub>2</sub>SO<sub>3</sub> and CO<sub>2</sub>.

**Figure 6.10** Conceptual flowsheet of reactive extraction-based process in which all three products are extracted in the same section (Type C process). The alcohol is converted into monoester prior to extraction. Benzoic acid is back-recovered by precipitation (option 3).

Hence, the optimal overall process flowsheet, for concrete process conditions and requirements, has to be chosen among the three options of the Type C process, i.e. the two conceptual flowsheets given in Figures 6.9 and 6.10 (the flowsheets of options 1 and 2 are identical, only one extractant is different). The results of the case-study (see Appendix A2) presented in Section 6.6 allow further comparison of these two conceptual flowsheets from the energy consumption, i.e. operational costs point of view.

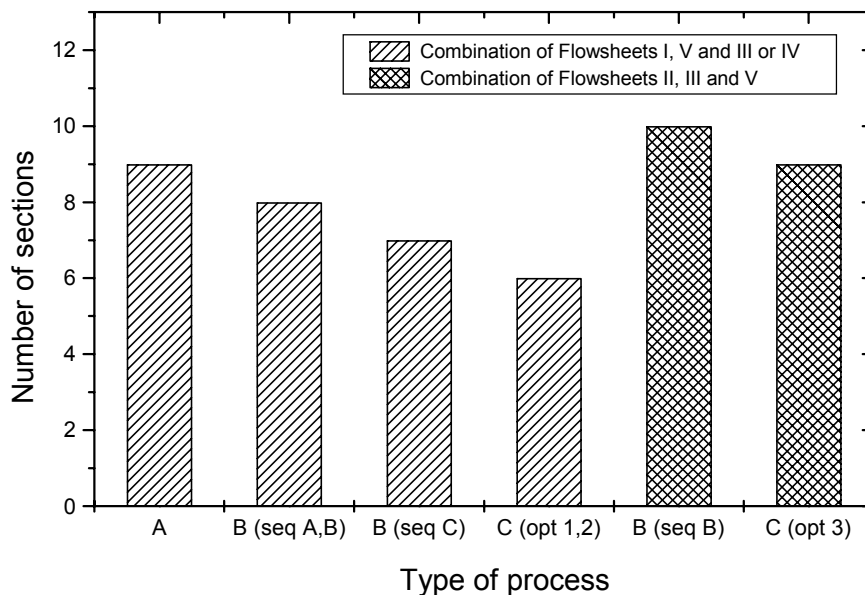


Figure 6.11 Comparison of the number of sections for different types of reactive extraction based processes.

### 6.5 Distillation based recovery from multicomponent solution

As explained in the introduction of this chapter, an adequate distillation based process must be used as a reference for comparison of the energy requirements with the reactive-extraction-based processes. Hence, based on the same recovery requirements such a process is proposed in Figure 6.12. It consists of three distillation sections. Toluene would be distilled in the first, benzaldehyde in the second and benzyl alcohol in the third section. Benzoic acid will be the bottom product of the third section.

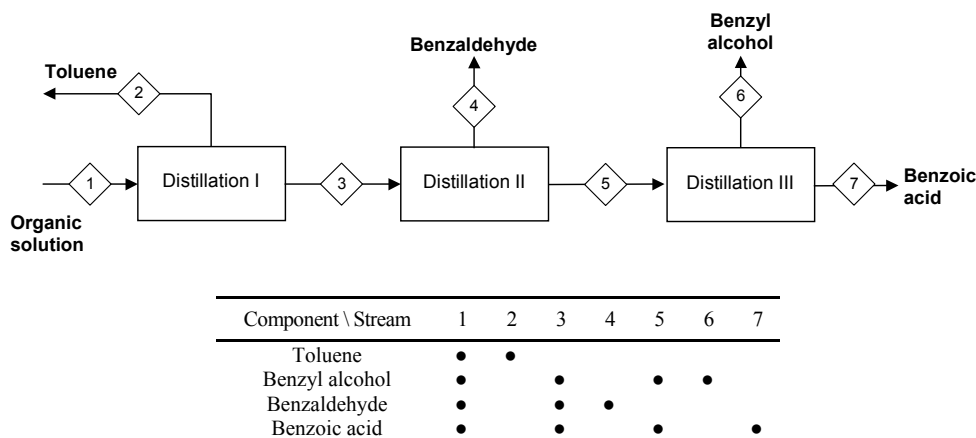


Figure 6.12 Conceptual flowsheet of the reference-distillation-based process for the recovery of toluene oxidation products.

Toluene, as the compound present in the largest quantity, should be removed as early as possible in the distillation train. It has the lowest boiling point of all components present in the mixture (see Table 6.3) and therefore that has to be done in the first section. Next, the oxidation products are recovered in the order of increasing boiling point since that requires the least amount of energy. It should be emphasised that this separation sequence is acceptable if equal amounts of all three products in the stream entering the distillation train

are present. The relative volatilities of the closest boiling compounds, given in Table 6.3, are high enough to enable an efficient separation in each section.

**Table 6.3** Boiling points ( $T_b$ ) and relative volatilities ( $\alpha$ ) for the two components having the closest boiling points (at the boiling point of the lower boiling one).

| Component      | $T_b$ (°C) | $\alpha$ (-) |
|----------------|------------|--------------|
| Toluene        | 110        | 5.0          |
| Benzaldehyde   | 179        | 2.2          |
| Benzyl alcohol | 205        | 5.1          |
| Benzoic acid   | 250        |              |

## 6.6 Comparison of reactive extraction with distillation process

Counting only the number of sections, the distillation-based process is more advantageous. Three sections are required for distillation and 6 to 9 for the reactive extraction processes of Type C. However, from the point of view of operational costs, it is believed that the extraction processes can offer a significant advantage. Therefore, the operational costs based on the costs of the consumed utilities for the required heat duties and workloads of the reactive extraction processes are compared with those of the reference-distillation-based process. This is done for a toluene oxidation process in which 5% of toluene is converted in the reactor into equal amounts of the three products (benzyl alcohol, benzaldehyde and benzoic acid). The details of these calculations are given in Appendix A2. However, the final results and the essential assumptions for this calculation are presented in Table 6.4. This table lists the operational costs per ton of products ( $C$ ) of each section for the distillation- and both optimal reactive-extraction-based processes (Type C).

A potential advantage of the reactive extraction processes can be quantified by the savings in operational costs ( $S$ ) defined as:

$$S = \frac{(C_{dist} - C_{ext})}{C_{dist}} \cdot 100\% \quad (6-1)$$

where  $C_{dist}$  and  $C_{ext}$  are the total operational costs of distillation and reactive extraction, respectively.

The savings in operational costs of the reactive extraction process with recovery of the unmodified alcohol are found to be minor (around 3%) relative to the distillation process, making this process an unattractive alternative to distillation. The reason is the necessity to have a rather high solvent-to-feed ratio in the forward extraction that also results in large flowrates entering the back-recovery sections. Such a solvent-to-feed ratio has to be applied due to a moderate distribution ratio of benzyl alcohol.

On the other hand, the reactive extraction process with monoesterification of alcohol offers more than 40% reduction in the operational costs. That reduction will be even higher if the conversion of toluene in the reactor is lower than 5%. Figure 6.13 shows the estimated savings in operational costs that both reactive extraction processes offer relative to the reference distillation process, as a function of the toluene conversion in the oxidation reactor. Basis for this estimation is the calculation made in Appendix A2 for 5% toluene conversion, assuming that the solvent-to-feed ratio in the forward extraction of the process in Figure 6.10 can be maintained proportional to the products flowrate, whereas for the extraction process in Figure 6.9 it must be kept constant. The reason for these assumptions is that the S/F ratio

of the forward extraction in Figure 6.10 depends only on the number of moles of extractants, whereas in the process in Figure 6.9 the effect of solvent volume is also important. All other parameters are assumed to remain the same as in the 5% toluene conversion process.

**Table 6.4** Operational costs subdivided per process section of the reference-distillation-based process (Figure 6.12) and the two optimal reactive extraction processes of Type C (Figures 6.9 and 6.10) assuming a toluene conversion in the reactor of 5%.

| Section   | C (€/t) <sup>a</sup> |
|---|----------------------|
| Reference-distillation-based process <sup>b</sup>   |                      |
| Distillation I  | 51.3                 |
| Distillation II   | 1.0                  |
| Distillation III  | 1.1                  |
| Total   | 53.4                 |
| Reactive-extraction-based process with recovery of unmodified alcohol <sup>c,d</sup>      |                      |
| Reactive extraction <sup>e</sup>  | 2.2                  |
| Precipitation and filtration <sup>f</sup>   | 6.2                  |
| Drying <sup>g</sup>   | 2.3                  |
| Back extraction <sup>h</sup>  | 21.9                 |
| Distillation I <sup>b</sup>   | 18.1                 |
| Distillation II <sup>b</sup>  | 1.0                  |
| Total   | 51.7                 |
| Reactive extraction based process with prior monoesterification of alcohol <sup>d,i</sup> |                      |
| Monoesterification <sup>j</sup>   | 0.0                  |
| Reactive extraction <sup>k</sup>  | 0.0                  |
| Back extraction <sup>h</sup>  | 9.4                  |
| Precipitation and filtration <sup>f</sup>   | 4.7                  |
| Drying <sup>g</sup>   | 6.3                  |
| Solid-liquid separation <sup>l</sup>  | 0.6                  |
| Anhydride regeneration <sup>m</sup>   | 0.7                  |
| Distillation I <sup>b</sup>   | 9.0                  |
| Distillation II <sup>b</sup>  | 1.0                  |
| Total   | 31.7                 |

<sup>a</sup> For more details and background on the choices, constraints and assumptions of the calculation of the operational costs, see Appendix A2.

<sup>b</sup> Costs associated with evaporation of the lightest compound, and in the Distillation I of the distillation-based process also with condensation of the evaporated toluene.

<sup>c</sup> S/F ratios of forward- and back-extraction are 0.8 and 1, respectively.

<sup>d</sup> Forward-extraction is performed at 25 °C, back-extraction at 98 °C, and precipitation at 10 °C and 30 bar.

<sup>e</sup> Costs associated with cooling the aqueous salt solution entering this section.

<sup>f</sup> Costs associated with cooling, compression and liquid transport to high pressure.

<sup>g</sup> Costs associated with evaporation of water.

<sup>h</sup> Costs associated with heating.

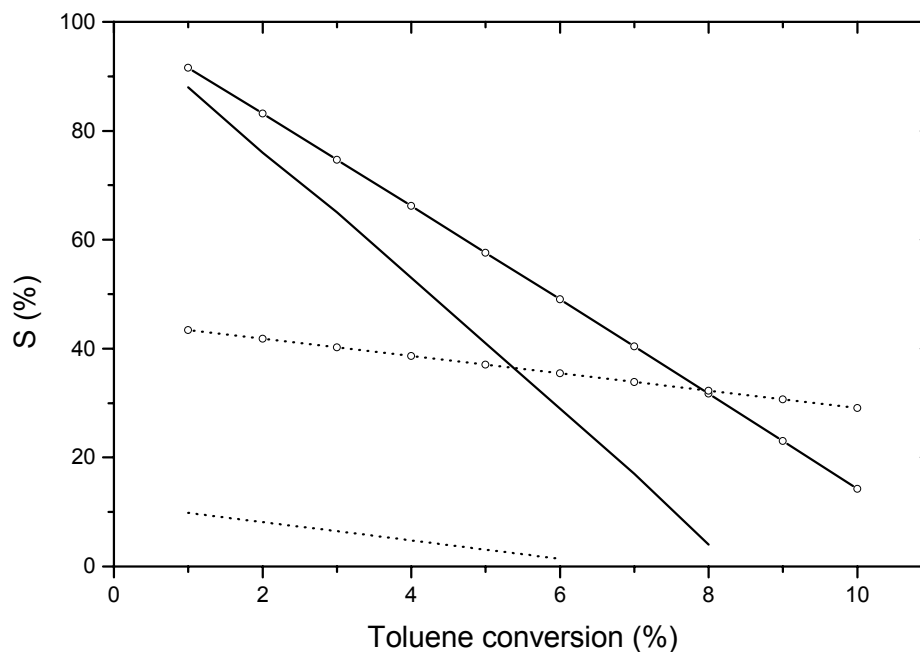
<sup>i</sup> S/F ratios of forward- and back-extraction are 0.4 and 1, respectively.

<sup>j</sup> It is performed in the oxidation reactor, and hence no costs are involved.

<sup>k</sup> Due to heat integration of the streams no utilities are consumed.

<sup>l</sup> Costs associated with melting of the dicarboxylic acid.

<sup>m</sup> Costs associated with heating of the dicarboxylic acid.



**Figure 6.13** Savings in operational costs of the two reactive extraction processes of Type C relative to the reference-distillation process. Solid lines represent the reactive extraction process with monoesterification of the alcohol and the dotted lines represent the process with extraction of the unmodified alcohol. The lines with circles represent the estimated savings for the potential extraction processes in which the back-recovery of benzaldehyde and benzyl alcohol is done by new phase formation.

Obviously, the savings in operational costs are strongly dependent on the toluene conversion in the oxidation reactor. It is clear that at conversions higher than 8% the proposed reactive extraction processes are not attractive any more. However, if a process requires a conversion lower than 5%, the operational costs can be reduced by more than 50% and up to 90% by applying the reactive extraction process with monoesterification of alcohol.

One of the cost drivers in both reactive extraction processes (see Table 6.4) is the distillation of toluene after back-extraction of benzaldehyde and benzyl alcohol. Elimination of this operation would yield an even larger reduction in operational costs. In this thesis the back-recovery of extracted alcohol and carbonyl compound is evaluated by back-extraction with a temperature shift which requires subsequent distillation. However, distillation of the back-extraction solvent would be eliminated if a temperature shift is applied in combination with formation of a new (liquid), oxygenate-rich phase, which can be simply decanted from the aqueous phase. Figure 6.13 also shows the savings that could be achieved by applying new phase formation instead of back-extraction. In the process with monoesterification the savings are especially beneficial in the region of toluene conversions higher than 5%, where more than 20% additional savings could be achieved. For the process with extraction of unmodified alcohol the use of new phase formation provides a constant increase in savings, providing savings relative to the distillation process in the range of 30 - 40%.

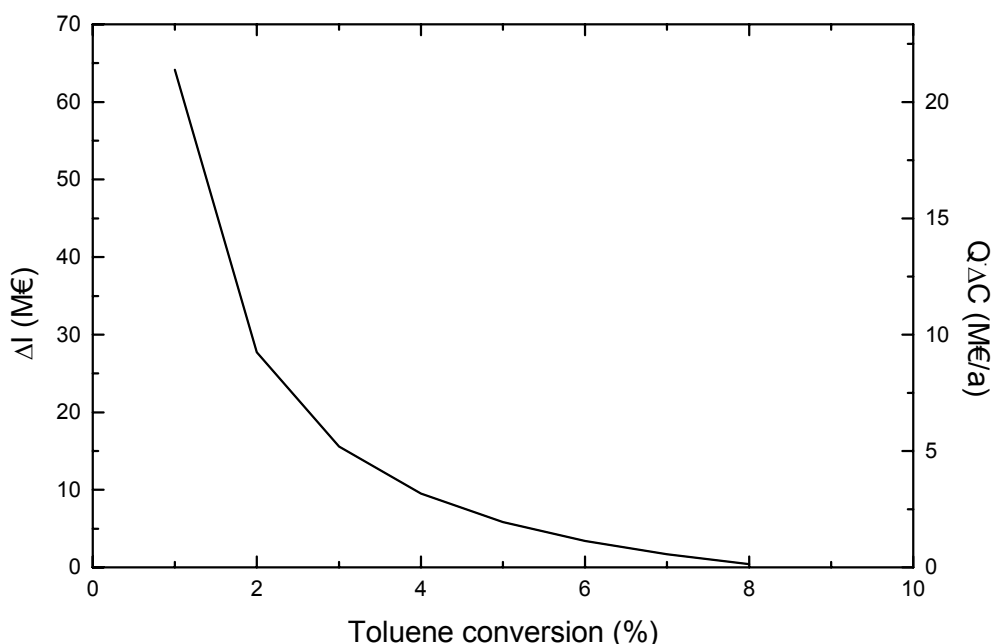
Another cost driver in the reactive-extraction-based processes is the temperature shift required for back-recovery. Heating is necessary to achieve a regeneration of benzaldehyde and benzyl alcohol from the chemically extracted forms, but if that regeneration can be achieved at a lower temperature than 98 °C (adopted for the calculation shown in Table 6.4), another reduction in the operational costs would be obtained.

To illustrate the effect of the discussed savings in operational costs, the resulting potential for additional capital investments ( $\Delta I$ ) in the reactive extraction process with monoesterification relative to the investments needed for the reference distillation process is determined as:

$$\Delta I = I^{ext} - I^{dist} = p \cdot (C_{dist} - C_{ext}) \cdot Q = p \cdot \Delta C \cdot Q \quad (6-2)$$

where  $p$  is the pay-back time (a) and  $Q$  is the production rate (t/a).

The results are shown as a function of the toluene conversion in Figure 6.14, adopting a pay-back time of 3 years and a production rate of 90000 t/a, as used in the case-study in Appendix A2. The right y-axis of the graph shows the absolute annual savings in the operational costs ( $Q \cdot \Delta C$ ).



**Figure 6.14** Potential for capital investments ( $\Delta I$ ) and annual savings in operational costs ( $Q \cdot \Delta C$ ) of the optimal reactive extraction process with monoesterification of alcohol relative to the reference-distillation-process as a function of the toluene conversion for a production rate of 90000 t/a, and a pay-back time of 3 years.

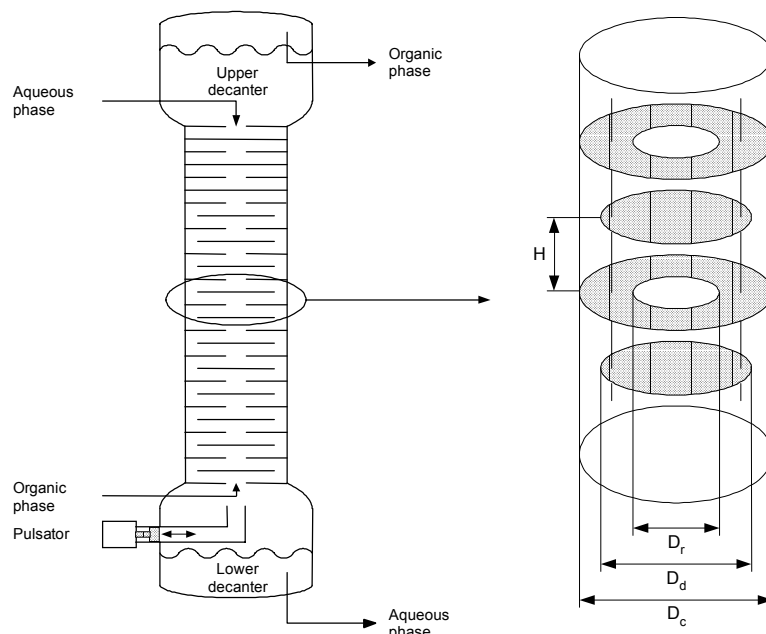
## 6.7 Feasibility of performing proposed reactive extraction in pilot plant setup

In order to evaluate whether the proposed reactive extraction solvents can be used in a typical extraction column, the recovery of one oxygenate is evaluated in a pilot plant extraction setup. As a representative case benzaldehyde is extracted from toluene by an aqueous solution of sodium hydrogen sulphite. The same extraction, but using pure water as the solvent, is also performed to demonstrate the effect of sodium hydrogen sulphite, i.e. the difference between reactive and physical extraction.

### 6.7.1 Extraction column characteristics

The core of the pilot plant is a pulsed disc and doughnut column (see Figure 6.15). The active height of the column is 4 m and its inner diameter 4.0 cm. The active volume of the

column is 4.1 l and the volume of each settler 2.2 l. The column is made of glass, whereas the internals are made of stainless steel. The dimensions of the internals are:  $D_r = 20.1$  mm,  $D_d = 34.3$  mm and  $H = 9.8$  mm (see Figure 6.15 for explanation of these geometrical parameters). The column is equipped with several sampling ports allowing sampling of each phase at different heights within the column. Furthermore, two additional side ports enable the sampling of relative large amounts of the column content allowing determination of the hold-up.



**Figure 6.15** (a) Pulsed disc and doughnut column, and (b) disc and doughnut internals.

## 6.7.2 Experimental procedure

A 1.5 wt% (0.1 M) solution of benzaldehyde in toluene is used as the feed. Such solution represents the organic solution of an oxygenate in toluene at a low toluene conversion in the reactor (see Chapter 1).

As the extraction solvent either a 1.5 M aqueous solution of sodium hydrogen sulphite or pure water was used. The aqueous solution of sodium hydrogen sulphite is selected since it provides a high distribution ratio toward benzaldehyde and allows a temperature shift for back-recovery (see Chapter 3). At concentrations of sodium hydrogen sulphite of around 1.5 M, this solvent shows the highest equilibrium distribution ratio (see Figure 3.3 in Chapter 3). Since the only focus of this analysis is to evaluate the efficiency of the forward-extraction of benzaldehyde from toluene, this concentration is adopted. However, for application in a process an optimal concentration of sodium hydrogen sulphite should be found considering not only the forward-extraction, but also the back-recovery.

The flowrate of the feed (organic phase) was 3.0, 3.5 or 7.0 l/h, whereas the feed rate of the solvent (aqueous phase) ranged from 3.5 to 14.0 l/h, resulting in solvent-to-feed ratios (S/F) between 0.5 and 4 (S/F was either 2 or 4 when the aqueous solution of hydrogen sulphite was the solvent). Furthermore, the organic phase was chosen to be dispersed. The reason for dispersing the organic phase, but also for applying high solvent-to-feed ratios although that might not be necessary, was the intention to provide as good conditions as possible for the extraction of benzaldehyde. Since the hold-up in this extraction column typically ranges



from 0.05 to 0.25, a large excess of aqueous solvent is present when the organic feed is dispersed. Furthermore, the ultimate intention is to operate the proposed extraction process at low S/F ratios. Hence, the feed would have to be dispersed in order to provide a large interfacial area and solvent would have to be kept as continuous phase to allow its longer residence time. Therefore, by dispersing the organic feed phase, the conditions are similar to the intended process operation.

The flowrates of the organic phase were kept at a minimum (around 3 l/h), whereas the maximum value of the pulsation rate ( $f \cdot A$ ) that could be achieved for the given conditions was applied to generate a high hold-up [the pulsation frequency ( $f$ ) was 2.5 Hz, with an amplitude ( $A$ ) of 13.5 mm]. Both is done to provide a long residence time of the organic phase to yield a high recovery of benzaldehyde from toluene.

All extractions are performed at room temperature.

The experiments were done as follows. First, the column was filled with the aqueous phase, and then the flow of the organic phase was initiated. The flowrates of both phases were set to the specified values and the level of the interface in the upper settler was monitored and controlled. After that level reached a constant value, the column was operated until four replacements of both phases were made within the column. After that, it is assumed that the column reached the steady state,<sup>6</sup> such that sampling could start. Several millilitres of liquid were left to flush each port before a sample was collected. The flowrates through the ports were of the order of less than a millilitre per minute. With these flows it could be assumed that the sampling did not influence the extraction behaviour within the column. Finally, after sampling each phase at different heights of the column, around 250 ml of the column content was taken at two different heights to determine the average hold-up.

The hold-up was determined by measuring the total volume ( $V_d + V_c$ ) and the volume of the dispersed phase ( $V_d$ ) after settling has been completed:

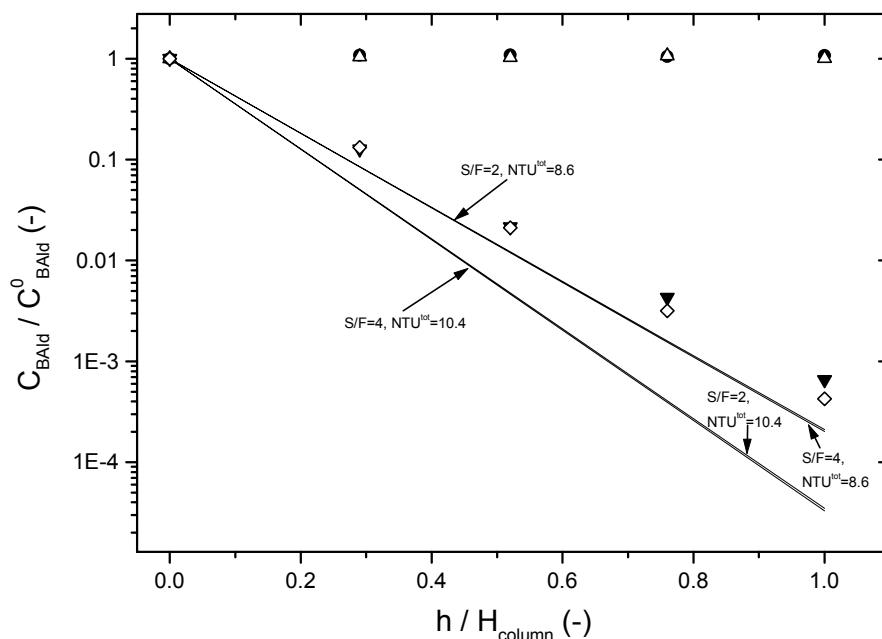
$$\varepsilon = \frac{V_d}{V_d + V_c} \quad (6-3)$$

Samples of the organic phase were analysed to determine the concentration of the benzaldehyde, using the analytical method already described in Chapter 3. The aqueous phase samples were analysed only in case pure water was the extraction solvent to check the mass balance.

### 6.7.3 Results and discussion

The results are presented in Figure 6.16 showing a normalised concentration profile as a function of the normalised height along the column. The organic phase was entering the column at height zero. The experimental data are shown as points, whereas the lines define the region that would be expected if pure physical extraction, instead of reactive extraction, was occurring (explained below). The measured hold-up and calculated residence time of the dispersed phase are given in Table 6.7.

As expected, practically no benzaldehyde is extracted into pure water. Due to the very low capacity of pure water, no difference between the two applied S/F ratios can be seen. On the other hand, by using the aqueous solution of sodium hydrogen sulphite a benzaldehyde recovery of up to 99.96% is achieved for the applied conditions. The influence of the S/F ratio in this case is visible, but a decrease from 4 to 2 results only in a slight final recovery drop, from 99.96% to 99.93%. This suggests that S/F ratio can be decreased further without a significant decrease of the recovery.



**Figure 6.16** Concentration profile of benzaldehyde in the dispersed organic phase as a function of the column height during the extraction at room temperature using: ●, pure water at  $S/F = 0.5$ ;  $\Delta$ , pure water at  $S/F = 3.5$ ;  $\nabla$ , aqueous 1.5 M solution of sodium hydrogen sulphite at  $S/F = 2$ ;  $\diamond$ , aqueous 1.5 M solution of sodium hydrogen sulphite at  $S/F = 4$ . The lines represent the concentration profiles if the performed extractions would be a pure physical extraction. One is for the minimum and the other for the maximum number of transfer units (NTU) found in the column.

**Table 6.7** Hold-up ( $\varepsilon$ ) and average residence time of the organic phase ( $\tau_f$ ).

| Solvent                         | F (l/h) | S/F (-) | $\varepsilon$ (-) | $\tau_f$ (min) <sup>c</sup> |
|---------------------------------|---------|---------|-------------------|-----------------------------|
| Pure water                      | 7.0     | 0.5     | 0.060             | 2.1                         |
| Pure water                      | 3.0     | 3.5     | 0.066             | 5.4                         |
| NaHSO <sub>3</sub> <sup>a</sup> | 3.5     | 2       | 0.097             | 6.8                         |
| NaHSO <sub>3</sub> <sup>a</sup> | 3.5     | 4       | 0.088             | 6.2                         |

<sup>a</sup> 1.5 M aqueous solution of sodium hydrogen sulphite.

<sup>c</sup> Average residence time of the organic phase ( $\tau_f = \frac{\varepsilon \cdot V_{column}}{F}$ ).

The lines in Figure 6.16 represent the concentration profiles if the performed extractions would be limited by mass transfer kinetics with no influence of the reaction kinetics at all, i.e. if the extraction would be a pure physical extraction. They are based on the experiments performed in the same column on a similar system involving only physical extraction of a solute from toluene into pure water. From those experiments the number of physical mass-transfer units (NTU) in the used extraction column is determined:<sup>7</sup>

$$NTU = \frac{1}{1-1/E} \ln \left[ \left( \frac{X_f - Y_s/m}{X_r - Y_s/m} \right) \left( 1 - \frac{1}{E} \right) + \frac{1}{E} \right] \quad (6-4)$$

where  $X$  and  $Y$  are the weight ratios of solute to solvent in the raffinate phase and the extract phase, respectively (Bancroft coordinates); the subscripts  $f$ ,  $r$  and  $s$  denote the feed, the raffinate and the solvent, respectively;  $m$  is the distribution ratio expressed in Bancroft coordinates and  $E$  is the extraction factor defined as:

$$E = m \frac{S'}{F'} \quad (6-5)$$

where  $S'/F'$  is extraction solvent to feed solvent flowrate ratio.

Equation (6-4) is valid for differential countercurrent contractors for a straight operating line and a straight equilibrium line with an intercept at zero. Although the equilibrium stage concept (well known Kremser equation) has proven useful in describing the performance of stage contactors, in differential contractors equilibrium between phases is never reached and therefore mass-transfer rate is important for the design procedure and therefore equation (6-4) is used.

Hence, from the physical extraction experiments, for a selected extraction factor and from measured solute concentrations at the top and the bottom of the column, the total number of mass-transfer units in the used column is calculated using equation (6-4). That value, corrected for the difference in hold-ups, is used to predict the concentration profile for the case of reactive extraction of benzaldehyde from toluene into the aqueous phase (the lines in Figure 6.16). The extraction factor is calculated using the overall distribution ratio determined in Chapter 3 (see Figure 3.3) as distribution ratio. The two sets of lines are drawn, where one represents the profile for the minimum number of transfer units, and the other for the maximum number of transfer units found in the physical extraction experiments. Therefore, they border the region in which experimental points would be expected to lie if pure physical extraction would occur, i.e. if NTU of physical extraction is equal to NTU of the reactive extraction. It should be emphasised that this approach assumes identical hydrodynamic characteristics in the extraction system from which the number of mass transfer units is determined and in the reactive extraction of benzaldehyde. Although they may not be exactly the same, for the purpose of a rough analysis, this may be considered as fulfilled.

As expected, the experimental results are located above the "physical extraction region" and less solute is extracted than would be in a pure physical extraction with the same extraction factor as in the reactive extraction. This is suggesting that the reaction kinetics effect the extraction and it must be included when dealing with the reactive extraction using aqueous solution of sodium bisulphite. However, in this specific case, the effect of the reaction kinetics seems to be not too strong, indicating that the reaction of benzaldehyde with sodium hydrogen sulphite is relatively fast. This is another confirmation of the poor mixing in the automated experimental setup on which liquid-liquid equilibrium experiments are performed (discussed in Chapters 2 and 3).

## 6.8 Conclusions

Based on the results of the conducted research on the reactive extraction of oxygenates from apolar organic solvents, an optimal reactive-extraction-based process has been established at a conceptual level for the recovery of benzyl alcohol, benzaldehyde and benzoic acid from toluene. The processes in which all three products are extracted simultaneously are found to be the most attractive because they allow a product recovery in the fewest number of process sections. However, it should be emphasised that this conclusion is drawn considering that no obstacles for the simultaneous extraction exist. At this stage that assumption is found valid, however its feasibility must be confirmed experimentally in future work.

Because the recovery of benzyl alcohol can be done either by extracting the unmodified alcohol or by modifying it into a monoester prior to extraction, two types of processes in

which all three products are extracted simultaneously are possible. By evaluating the operational costs of these two process types, it is concluded that although the one with the recovery of the unmodified alcohol offers a process with less sections, its operational costs are much higher than of the process with monoesterification. Hence, the latter is considered as the optimal reactive-extraction-based process of this work for the simultaneous recovery of the three toluene oxygenates.

When compared with the adequate distillation-based process, the optimal reactive extraction process offers a significant reduction in the operational costs. The savings depend on the toluene conversion, i.e. on the concentration of products in the organic feed. At very low conversions (1 - 5%) these savings are found to be between 85 and 40%. As the conversion increases, the advantage of the reactive extraction process reduces and it is estimated that above a toluene conversion of 8%, the extraction process does not offer any savings relative to the distillation process. As an illustration, for a typical production rate of 90000 t/a and at 5% toluene conversion, the mentioned annual savings in the operational costs would reach 1.9 M€/a, allowing 5.7 M€ higher capital investments than in a distillation-based process (pay-back time is taken to be 3 years).

Up to 20% additional operational costs savings are seen to be possible by replacing the back-extraction of benzyl alcohol and benzaldehyde with the back-recovery by new phase formation. Therefore, the technical feasibility of this option should be evaluated in future work.

Finally, in this chapter it is experimentally demonstrated that a very efficient extraction of benzaldehyde can be performed in a pulsed disc and doughnut column using an aqueous solution of sodium hydrogen sulphite as the reactive extraction solvent. The recovery higher than 99.9% is achieved in an extraction column of 4 m in height and 4.0 cm in diameter, applying a solvent-to-feed ratio of 2 and higher. Future work should lead to the optimisation of the extraction conditions by evaluating this extraction at low solvent-to-feed ratios. It should also establish an optimal extractant concentration considering both the forward-extraction and the back-recovery.

---

## Literature Cited

- (1) Szejtli, J. *Cyclodextrin Technology*; Kluwer Academic Publishers: Dordrecht, 1988.
- (2) Rekharsky, M. V.; Inoue, Y. Complexation Thermodynamics of Cyclodextrins. *Chem. Rev.* **1998**, *98*, 1875-1917.
- (3) Stella, V. J.; Rao, V. M.; Zannon, E. A.; Zia, V. Mechanism of Drug Release from Cyclodextrin Complexes. *Advanced Drug Delivery Rev.* **1999**, *36*, 3-16.
- (4) Safarik, D. J.; Eldridge, R. B. Olefin/Paraffin Separations by Reactive Absorption; A Review. *Ind. Eng. Chem. Res.* **1998**, *37*, 2571-2581.
- (5) Nymeijer, K. *Gas-Liquid Membrane Contactors for Olefin/Paraffin Separation*; PhD Thesis. PrintPartners Ipskamp: Enschede, 2003.
- (6) Jahya, A. B.; Stevens, G. W.; Pratt, H. R. C. Mass Transfer Studies for a Pulsed Disc and Doughnut Extraction Column. In *MINPREX 2000*, Melbourne, 2000.
- (7) Perry, R. H.; Green, D. *Perry's Chemical Engineers' Handbook*; McGraw-Hill: Singapore, 1984.



## Chapter 7

# Conclusions and recommendations

The objective of this study was to explore the feasibility of using aqueous salt solutions as reactive extraction solvents for the recovery of oxygenates like carbonyl compounds, carboxylic acids and alcohols from a dilute apolar organic solution. The feasibility is characterised by evaluating the extraction capacity and selectivity of aqueous salt solutions toward the mentioned oxygenates, as well as the efficiency of the back-recovery.

As characterisation of the extraction performance of many salt solutions for various oxygenates was required, an automated workstation for liquid-liquid equilibrium measurements has been developed. Up to 65 equilibria can be measured continuously with no necessity for human interference, whereas up to 36 equilibrium experiments per day in a typical two-liquid-phase system, compared to only 3 that could be done by jacketed-glass-cell-based procedure, can be performed using this workstation. The results of the automated measurements are found to be in very good agreement with the values reported in the literature, suggesting a good accuracy. Furthermore, a satisfying repeatability, quantified by a coefficient of variation of 1.8%, is also obtained.

### 7.1 Extraction capacity of aqueous salt solutions

It is found that the capacity of the adequate aqueous salt solutions can be very high for carboxylic acids, aldehydes and some ketones, whereas for alcohols and the ketones with a less accessible carbonyl group, it is slightly above the required minimum, which is characterised by a distribution ratio of 1. However, by modifying the alcohol into an easy-extractable form prior to the extraction, adequate salt solutions can provide a very high extraction capacity.

In the extraction of aldehydes and ketones, aqueous solutions of hydrogen sulphite or hydrazines provide equilibrium distribution ratios of around 3 for ketones with hindered carbonyl groups up to 300 for aldehydes, what is orders of magnitude higher than provided by pure water. Although amine salt solutions show a much lower capacity, exhibited by equilibrium distribution ratios not higher than 1, still a 50 to 100 times increase has been achieved relative to pure water. It is observed that the capacity of an aqueous salt solution in the extraction of carbonyl compounds decreases in the order: linear aldehyde > aromatic aldehyde > cyclic ketone > linear ketone.

An aqueous solution of sodium hydrogen carbonate appears to be an efficient solvent for the extraction of carboxylic acids by providing distribution ratios of up to several hundreds, what is again orders of magnitude higher than with pure water. Distribution ratios of an aromatic and C<sub>6</sub>-linear-aliphatic acid are found to be as high as 200, whereas for a C<sub>10</sub>-linear-aliphatic acid this ratio was around 3. Besides the dissociation constant of the acid, also the solubility of carbon dioxide in the apolar organic solvent has been found to determine the value of the distribution ratio.

Among the several evaluated extractants for the recovery of the unmodified alcohol, only hydroxypropyl-cyclodextrins and silver nitrate are found to improve the distribution ratio of benzyl alcohol between the aqueous and organic phases relative to pure water. However, only moderate equilibrium distribution ratios in the range of 1.5 to 2.7 are provided. That is a 5 - 10 times increase relative to pure water.

If the alcohol is modified prior to the extraction into a monoester, a benign solvent like an aqueous solution of sodium hydrogen carbonate provides a three orders of magnitude higher distribution ratio of benzyl alcohol than with pure water with a value around 200. It has been demonstrated that the required modification of alcohols into a monoester for such extraction can be done efficiently in an apolar organic solvent, without need for a catalyst.

## 7.2 Selectivity toward oxygenates of aqueous salt solutions

In most of the evaluated cases the solubility of the apolar organic solvent remains at least the same as in pure water. As there is an increase in distribution ratio of the oxygenates, also an increase in the selectivity toward oxygenates occurs. In some cases the used salts caused even a decrease in solubility of the apolar organic solvent in the aqueous phase relative to pure water. In that way, the selectivity toward oxygenates is not only improved by enhancing the distribution ratio of an oxygenate, but also by reducing the distribution ratio of the organic solvent.

As exceptions, hydroxypropyl-cyclodextrins and especially silver nitrate, used for the extraction of unmodified alcohols, are found to increase the solubility of toluene in the aqueous phase. This causes a decrease in selectivity toward the alcohol compared to pure water, what makes these extractants less attractive.

## 7.3 Back-recovery after extraction using aqueous salt solutions

It is found that most of the extracted oxygenates can be back-recovered from the aqueous phase by either back-extraction or by new phase formation. This can be realised by applying a moderate temperature or pH shift by using carbon dioxide under moderate pressures. The carbon dioxide-aided-pH-shift is very attractive in combination with a forward-extraction with an aqueous solution of sodium hydrogen carbonate, because no by-products (inorganic salts) are formed and only environmentally benign chemicals are used.

In the extraction of carbonyl compounds by sodium hydrogen sulphite the effect of a temperature increase from 25 to 70 °C resulted in a decrease of the distribution ratio of up to 20 times. For amine salts this effect was somewhat weaker. For other cases, as in the use of a hydrazine salt solution to extract benzaldehyde, a temperature shift did not show potential to be applied.

Recoveries of around 50% are observed in the back-recovery of the extracted carboxylic acids either by new phase formation or by back-extraction aided by carbon dioxide under pressure. If a salting-out agent like sodium nitrate is added to the aqueous phase, equilibrium



stage recoveries of up to 90 %, are reached, whereas a recovery of 50 % is already achieved at a pressure of 5 bar.

A temperature shift is also found to be effective for the back-recovery of modified alcohols because the rate of hydrolysis of the modified alcohol can be efficiently controlled by temperature. A temperature increase from 50 to 70 °C shows an enhancement of the hydrolysis rate by a factor of ten.

#### **7.4 Conceptual process design for oxygenate recovery based on reactive extraction**

By evaluating various potential reactive-extraction-based processes at a conceptual level, it is found that those in which all three products are extracted simultaneously appear to be the most attractive as they require the fewest number of unit operations. Evaluation of the operational costs of those processes showed that, although the one with the recovery of the unmodified alcohol offers a process with less unit operations, its operational costs are much higher than of the process with extraction of monoesterified alcohol.

Compared with an adequate distillation-based process, it is seen that the reactive extraction process with monoesterification offers a significant reduction in the operational costs. At low oxygenate concentrations (1 - 5%) the savings are found to be between 85 and 40%. As the concentration increases, the advantage of the reactive extraction process reduces, and it is estimated that above 8% toluene conversion the extraction process does not offer any savings relative to the distillation process. As an illustration, for a typical production rate of 90000 t/a and at 5% toluene conversion, the mentioned annual reduction in operational costs would reach 1.9 M€/a, providing 5.7 M€ room for additional capital investments compared to a distillation-based process (with a pay-back time of 3 years).

Furthermore, an additional 20% increase in the operational cost savings is expected to be possible by replacing the back-extraction of benzyl alcohol and benzaldehyde with the back-recovery by new phase formation.

#### **7.5 Feasibility of performing reactive extraction in typical extraction setup**

The feasibility of performing reactive extraction with aqueous salt solutions in a typical extraction setup is evaluated experimentally. More than 99.9% of the benzaldehyde was recovered from a dilute toluene solution in a pilot plant pulsed disc and doughnut column using an aqueous solution of sodium hydrogen sulphite in a column of 4 m in height and 4.0 cm in diameter, applying solvent-to-feed ratio of 2 and higher. Furthermore, it is found that due to the effect of reaction kinetics involved in the reactive extraction, less benzaldehyde is extracted at the same column height than would be the case in a pure physical extraction with the same hydrodynamic characteristics and equilibrium distribution ratio.

#### **7.6 Recommendations for future research**

The following recommendations for future research can be suggested:

- A. In this work the forward-extraction and back-recovery of each class of oxygenates are analysed independently from each other. Future studies should experimentally evaluate the complete recovery cycle of an oxygenate, from solute present in an organic solution to pure product;

- 
- B. This work was limited to the experimental evaluation of the recovery of an oxygenate from a single-oxygenate organic solution. Further studies should evaluate the simultaneous extraction of several oxygenates of different classes from the same solution. The feasibility of such approach concerning the forward-extraction, but also the subsequent back-recovery of oxygenates from the multicomponent mixture should be analysed.
- C. Back-extraction with a temperature shift is considered in this thesis as an option for the back-recovery of extracted modified alcohols and carbonyl compounds. Future research should evaluate the technical feasibility of the application of a temperature shift in combination with the formation of a new, oxygenate-rich phase. This option minimises the need for distillation and provides further reduction in operational costs.
- D. The feasibility of the reactive extraction of an alcohol by modifying it into a monoester prior to the extraction is shown. However, to be able to optimise this recovery technique the following issues should be addressed in the future work:
- Detailed analysis of the interactions of alcohols with cyclic anhydrides, which will allow selection of an optimal cyclic anhydride for the modification of a specific alcohol,
  - Quantification of all parameters influencing the reactive extraction of modified alcohol as a function of temperature, pH and agitation conditions to be able to establish optimal conditions for the extraction, and
  - Feasibility of regeneration of the cyclic anhydride after extraction by the CO<sub>2</sub>-aided-precipitation of dicarboxylic acid and its dehydration to cyclic anhydride.
- E. An option in which the modification of an alcohol prior to direct extraction in the oxidation reactor, is proposed and even found beneficial for the process performance. This option should be evaluated in detail during future research.
- F. The technical feasibility of performing a reactive extraction in a pulsed disc and doughnut extraction column has been shown in this thesis for relatively high solvent-to-feed ratios and a large excess of extractant. Future work should lead to optimisation of the extraction conditions for that column by evaluating this extraction at lower solvent-to-feed ratios and using lower extractant concentrations in the aqueous phase. Furthermore, performing the reactive extraction in other types of extraction equipment, besides the pulsed disc and doughnut column, should also be evaluated.
- G. Finally, to be able to select an optimal type of extraction equipment and to make detailed process designs, characterisation of the kinetic aspects of both forward-extraction and back-recovery operations should be done, including also the characterisation of the physical properties of the liquids that influence the hydrodynamics of the separation process. This investigation should involve the salt solutions that showed the best performance in this research.

# List of symbols

|                          |   |
|--------------------------|---|
| $a$                      | activity; interfacial area, $\text{m}^2 \cdot \text{m}^{-3}$  |
| $A\phi$                  | Debye-Hückel parameter for osmotic coefficient  |
| $b$                      | Pitzer's parameter equal to 1.2, $\text{kg}^{0.5} \cdot \text{mol}^{-0.5}$                                    |
| $c$                      | concentration, $\text{mol} \cdot \text{l}^{-1}$   |
| $c^{\text{sol}}$         | solubility, $\text{mol} \cdot \text{l}^{-1}$  |
| $C$                      | operational costs per ton of products, $\text{€} \cdot \text{t}^{-1}$   |
| $C_{\text{dist}}$        | operational costs per ton of products of reference distillation-based process, $\text{€} \cdot \text{t}^{-1}$ |
| $C_{\text{ext}}$         | operational costs of reactive-extraction-based process, $\text{€} \cdot \text{t}^{-1}$                        |
| $C_p$                    | specific heat capacity, $\text{J} \cdot \text{mol}^{-1} \cdot \text{K}^{-1}$                                  |
| $C_{\text{ut}}$          | annual operational (utility) costs, $\text{€} \cdot \text{a}^{-1}$  |
| $D$                      | dielectric constant   |
| $D_i$                    | overall distribution ratio of a specie $i$  |
| $e$                      | elementary charge, C  |
| $E$                      | solvent volumetric expansion, %   |
| $F$                      | feed flowrate, $\text{l} \cdot \text{h}^{-1}$   |
| $h$                      | position in extraction column, m  |
| $H_{\text{column}}$      | total height of extraction column, m  |
| $He$                     | Henry's coefficient, Pa   |
| $\Delta H_{\text{melt}}$ | heat of melting, $\text{J} \cdot \text{mol}^{-1}$   |
| $\Delta H_{\text{vap}}$  | heat of evaporation, $\text{J} \cdot \text{mol}^{-1}$   |
| $I$                      | ionic strength, $\text{kg} \cdot \text{mol}^{-1}$   |
| $\Delta I$               | potential for capital investments, €  |
| $k$                      | Boltzmann's constant, $\text{J} \cdot \text{K}^{-1}$ ; reaction rate constant; ratio of heat capacities       |
| $k_{\text{hyd}}$         | hydrolysis rate constant  |
| $k_S$                    | Setschenow constant, $\text{kg} \cdot \text{mol}^{-1}$  |
| $K$                      | reaction equilibrium constant   |
| $Ka$                     | acid dissociation constant, $\text{mol} \cdot \text{l}^{-1}$  |
| $K_D$                    | physical distribution ratio   |
| $(K_D)'$                 | physical distribution ratio for no-salt conditions  |
| $(K_L \cdot a)_i$        | product of overall mass transfer coefficient and interfacial area, $\text{m} \cdot \text{s}^{-1}$             |
| $Ks$                     | solubility equilibrium constant   |
| $m$                      | molality, $\text{mol} \cdot \text{kg}^{-1}$   |
| $\dot{m}$                | mass flowrate, $\text{t} \cdot \text{a}^{-1}$   |
| $m^0$                    | standard molality of 1 $\text{mol} \cdot \text{kg}^{-1}$  |
| $M$                      | molar mass, $\text{g} \cdot \text{mol}^{-1}$  |
| $n$                      | number of moles, mol  |
| $N_A$                    | Avogadro's number, $\text{mol}^{-1}$  |
| $p$                      | partial pressure, Pa; total pressure, Pa; pay-back time, a  |
| $P$                      | absolute pressure, Pa   |
| $P^{\text{com}}$         | power of gas compression, kW  |

---

|            |   |
|------------|---|
| $P^{pump}$ | power of liquid transport, kW   |
| $P^{sat}$  | saturated vapour pressure, Pa   |
| $P_i$      | partial pressure, bar   |
| $Q$        | production rate, t·a <sup>-1</sup>  |
| $Q^{con}$  | condensation duty, GJ·t   |
| $Q^{ev}$   | evaporation duty, GJ·t <sup>-1</sup>                                      |
| $Q^{h/c}$  | heating/cooling duty, GJ·t <sup>-1</sup>                                  |
| $Q^{melt}$ | melting duty, GJ·t <sup>-1</sup>  |
| $r_A$      | reaction rate, mol·l <sup>-1</sup> ·min <sup>-1</sup>                     |
| $R$        | recovery, %; Universal gas constant, J·mol <sup>-1</sup> ·K <sup>-1</sup> |
| $R^o$      | recovery into organic solvent, %  |
| $S$        | solubility, mol·l <sup>-1</sup> ; operational cost savings, %             |
| $t$        | time, min   |
| $T$        | temperature, K or °C  |
| $T_b$      | boiling point, K or °C  |
| $V$        | volume, m <sup>3</sup>  |
| $V_c$      | volume of continuous phase, m <sup>3</sup>                                |
| $V_d$      | volume of dispersed phase, m <sup>3</sup>                                 |
| $V_h$      | volume of vessel's headspace, m <sup>3</sup>                              |
| $w$        | mass fraction   |
| $W$        | work, J·mol <sup>-1</sup>   |
| $W^{com}$  | work load for gas compression, GJ·t <sup>-1</sup>                         |
| $W^{pump}$ | work load for liquid transport, GJ·t <sup>-1</sup>                        |
| $x$        | liquid phase mole fraction  |
| $y$        | vapour phase mole fraction  |
| $z$        | ion valence   |

### Greek symbols

|                 |   |
|-----------------|---|
| $\alpha$        | Pitzer's parameter equal to 2.0, kg·mol <sup>-0.5</sup> ; relative volatility |
| $\beta$         | binary interaction parameter, kg·mol <sup>-1</sup> ; selectivity              |
| $\gamma$        | activity coefficient  |
| $\varepsilon$   | extraction column hold-up   |
| $\varepsilon_0$ | permittivity of free space, C <sup>2</sup> ·N <sup>-1</sup> ·m <sup>-2</sup>  |
| $\rho$          | density, kg·m <sup>-3</sup>   |
| $\tau_f$        | residence time of feed in extraction column, min                              |
| $\xi$           | reaction conversion   |

### Subscripts

|        |                        |
|--------|------------------------|
| $0$    | pure water             |
| $a$    | aqueous phase          |
| $Ac^-$ | carboxylate ion        |
| $Alc$  | alcohol                |
| $AOS$  | apolar organic solvent |
| $BAC$  | benzoic acid           |
| $BAlc$ | benzyl alcohol         |

---

|                                    |   |
|------------------------------------|---|
| <i>C</i>                           | carbonyl compound                       |
| <i>Col</i>                         | cyclohexanol                            |
| <i>dist</i>                        | distillation process                    |
| <i>HexAc</i>                       | hexanoic acid                           |
| <i>Hol</i>                         | 1-hexanol                               |
| <i>DAc</i>                         | decanoic acid                           |
| <i>CEAlc</i>                       | chemically extracted alcohol            |
| <i>CD</i>                          | cyclodextrin                            |
| <i>CO<sub>2</sub></i>              | carbon dioxide                          |
| <i>CO<sub>3</sub><sup>2-</sup></i> | carbonate ion                           |
| <i>ext</i>                         | extractant; reactive extraction process |
| <i>H<sup>+</sup></i>               | hydrogen ion                            |
| <i>H<sub>2</sub>CO<sub>3</sub></i> | carbonic acid                           |
| <i>H<sub>2</sub>O</i>              | water                                   |
| <i>HAc</i>                         | carboxylic acid                         |
| <i>HBA<sup>n</sup></i>             | protonated basic anion                  |
| <i>HCO<sub>3</sub><sup>-</sup></i> | hydrogen carbonate ion                  |
| <i>HSO<sub>3</sub><sup>-</sup></i> | hydrogen sulphite ion                   |
| <i>i</i>                           | compound                                |
| <i>ME</i>                          | monoester                               |
| <i>ME<sup>-</sup></i>              | deprotonated monoester                  |
| <i>Na<sup>+</sup></i>              | sodium ion                              |
| <i>NaBen</i>                       | sodium benzoate                         |
| <i>NaDec</i>                       | sodium decanoate                        |
| <i>NaHCO<sub>3</sub></i>           | sodium hydrogen carbonate               |
| <i>o</i>                           | organic phase                           |
| <i>Ox</i>                          | oxygenate                               |
| <i>OxS</i>                         | oxygenate-salt complex                  |
| <i>OH<sup>-</sup></i>              | hydroxide ion                           |
| <i>P</i>                           | of a product                            |
| <i>R-COOH</i>                      | carboxylic acid                         |
| <i>S</i>                           | salt                                    |
| <i>s</i>                           | solids; apolar organic solvent          |
| <i>w</i>                           | water                                   |

### Superscripts

|                       |                              |
|-----------------------|------------------------------|
| <i>0</i>              | initial conditions           |
| <i>tot</i>            | total amount                 |
| <i>a</i>              | aqueous phase                |
| <i>dist</i>           | distillation process         |
| <i>e</i>              | equilibrium                  |
| <i>ext</i>            | reactive extraction process  |
| <i>o</i>              | organic phase                |
| <i>n</i>              | absolute value of ion charge |
| <i>H<sub>2</sub>O</i> | pure water                   |
| <i>AOS</i>            | apolar organic solvent       |



## Appendix A1

# Model parameters for recovery of carboxylic acids

If the temperature dependency of a parameter was reported as an equation, such relation was adopted. However, when that was not available, the parameter values were fitted as a function of temperature using a polynomial expression, not higher than second order.

**Table A1.1** Henry's coefficient of carbon dioxide in equation (4-1) or (4-2)

$$(H_{CO_2}^i = F_1 T + F_2 \text{ or } \ln \left( \frac{H_{CO_2}^i}{0.1 \cdot m_{water}^a} \right) = \left( \frac{G_1}{T} + G_2 \ln T + G_3 T + G_4 \right)^a).$$

| Solvent <i>i</i>           | Parameters                                 |                          |           |            |                          |           |
|----------------------------|--|--------------------------|-----------|------------|--------------------------|-----------|
|                            | $10^{-6} \cdot F_1$ (Pa·°C <sup>-1</sup> ) | $10^{-6} \cdot F_2$ (Pa) | $G_1$ (K) | $G_2$ (-)  | $G_3$ (K <sup>-1</sup> ) | $G_4$ (-) |
| Toluene <sup>b</sup>       | 0.1333                                     | 4.988                    |           |            |                          |           |
| n-Hexane <sup>c</sup>      | 0.0744                                     | 5.240                    |           |            |                          |           |
| n-Decane <sup>d</sup>      | 0.1160                                     | 5.310                    |           |            |                          |           |
| Benzaldehyde <sup>e</sup>  | 0.1521                                     | 4.347                    |           |            |                          |           |
| Benzylalcohol <sup>f</sup> | 0.1995                                     | 16.37                    |           |            |                          |           |
| Water <sup>a</sup>         | -17060.71                                  |                          | 68.31596  | 0.06598907 | 430.1920                 |           |

<sup>a</sup> The equation is reported by Kawazuishi and Prausnitz (1987)<sup>13</sup> for  $0 < T < 200$  °C. Their original expression describes Henry's constant in bar·kg/mol and is therefore divided by  $0.1 \cdot m_{water}^a$  to give (approximately) Henry's constant in MPa.

<sup>b</sup> Derived from data reported by Ng and Robinson (1979),<sup>1</sup> Fink and Hershey (1990),<sup>2</sup> Tan *et al.* (1991)<sup>3</sup> and Sebastian *et al.* (1980)<sup>4</sup> for  $35 < T < 150$  °C.

<sup>c</sup> Derived from data reported by Ohgaki and Katayama (1976)<sup>5</sup> for  $P < 5$  MPa and  $25 < T < 40$  °C.

<sup>d</sup> Derived from data reported by Reamer and Sage (1963)<sup>6</sup> for  $P < 3.5$  MPa and  $4 < T < 38$  °C.

<sup>e</sup> Derived from data reported by Kim *et al.* (1989)<sup>7</sup> for  $P < 5$  MPa and  $70 < T < 100$  °C.

<sup>f</sup> Derived from data reported by Chen and Lee (1997)<sup>8</sup> for  $P < 5$  MPa and  $60 < T < 180$  °C.

**Table A1.2** Vapour pressures in equation (4-3) or (4-4) ( $P_i^{sat} = A_1 \cdot T^2 + A_2T + A_3$ ).

| Component <i>i</i>         | A <sub>1</sub> (Pa·°C <sup>-2</sup> ) | A <sub>2</sub> (Pa·°C <sup>-1</sup> ) | A <sub>3</sub> (Pa) |
|----------------------------|---------------------------------------|---------------------------------------|---------------------|
| Water <sup>a</sup>         | 2.7860                                | 29.582                                | 640.19              |
| Toluene <sup>a</sup>       | 2.8961                                | 48.521                                | 845.62              |
| n-Hexane <sup>a</sup>      | 11.604                                | 287.09                                | 5986.8              |
| Benzaldehyde <sup>b</sup>  | 0.0402                                | 2.8126                                | 32.06               |
| Benzylalcohol <sup>c</sup> | -                                     | 0.45                                  | -2.6                |

<sup>a</sup> Data from Perry and Green (1984)<sup>9</sup> for 0 < T < 25 °C (water), -4 < T < 32 °C (toluene) and -2 < T < 32 °C (n-hexane).  
<sup>b</sup> Data from Perry and Green (1984)<sup>9</sup> and Lide (2002)<sup>10</sup> for -9 < T < 26 °C.  
<sup>c</sup> Data from Lide (2002)<sup>10</sup> for 8 < T < 28 °C.

**Table A1.3** Solubility equilibrium constants of carboxylic acids in equation (4-7) or (4-8) ( $K_{HAc^s}^i = B_1 \cdot T^2 + B_2T + B_3$ ).<sup>a</sup>

| Solvent <i>i</i>     | B <sub>1</sub> (°C <sup>-2</sup> ) | B <sub>2</sub> (°C <sup>-1</sup> ) | B <sub>3</sub> (-)     |
|----------------------|------------------------------------|------------------------------------|------------------------|
| Benzoic acid         |                                    |                                    |                        |
| Water <sup>b</sup>   | 2.501·10 <sup>-7</sup>             | 5.985·10 <sup>-6</sup>             | 2.022·10 <sup>-4</sup> |
| Toluene <sup>b</sup> | 5.081·10 <sup>-5</sup>             | 9.592·10 <sup>-4</sup>             | 2.980·10 <sup>-2</sup> |
| Hexanoic acid        |                                    |                                    |                        |
| Water <sup>c</sup>   | -                                  | 7.933·10 <sup>-6</sup>             | 1.342·10 <sup>-3</sup> |

<sup>a</sup>  $K_{HAc^s}^i$  is given in mol<sup>acid</sup>/mol<sup>solution</sup> / mol<sup>solvent</sup>/mol<sup>solution</sup>, see equations (4-7) and (4-8)  
<sup>b</sup> Derived from the solubility data of Stephen and Stephen (1963).<sup>11</sup>  
<sup>c</sup> Derived from the solubility data at 0 - 60°C reported by Ralston and Hoerr (1942).<sup>12</sup>

**Table A1.4** Setschenow constant in equation (4-6) or (4-9) ( $k_{S,i} = E_1 \cdot T + E_2$ ).

| Component <i>i</i> | Salt                           | E <sub>1</sub> (kg/mol°C) | E <sub>2</sub> (kg/mol) |
|--------------------|--------------------------------|---------------------------|-------------------------|
| Carbon dioxide     | NaCl <sup>a</sup>              | 0.0006                    | 0.0882                  |
|                    | NaNO <sub>3</sub> <sup>a</sup> | 0.0006                    | 0.1139                  |
| Benzoic acid       | NaCl <sup>b</sup>              | 0.0031                    | 0.1015                  |
|                    | NaNO <sub>3</sub> <sup>b</sup> | 0.0002                    | 0.0662                  |

<sup>a</sup> The value of  $k_{S,CO_2}$  at 25 °C is reported by Hermann *et al* (1995)<sup>16</sup> and the values at other temperatures for NaCl are derived from solubility data reported by Duan and Sun (2003),<sup>17</sup> while for NaNO<sub>3</sub> the temperature dependence is assumed to be the same as for NaCl.  
<sup>b</sup> The value of  $k_{S,HAc}$  at 25 °C is reported by Sergeeva (1965)<sup>18</sup> for NaCl and by Long and McDevit (1952)<sup>19</sup> for NaNO<sub>3</sub> and the values at other temperatures are derived from solubility data reported by Stephen and Stephen (1964).<sup>20</sup>



**Table A1.5** Reaction equilibrium constants in equation (4-11a), (4-11b), (4-12a), (4-13a) or (4-14a) ( $K = C_1 \cdot T^2 + C_2 T + C_3$  or  $K = \exp\left(\frac{D_1}{T} + D_2 \ln T + D_3 T + D_4\right)^a$ ).

| Reaction        | Parameters                        |                                   |                                   |           |
|-----------------|-----------------------------------|-----------------------------------|-----------------------------------|-----------|
|                 | $C_1$ ( $^{\circ}\text{C}^{-2}$ ) | $C_2$ ( $^{\circ}\text{C}^{-1}$ ) | $C_3$ (-)                         |           |
| 11 <sup>b</sup> | -                                 | -                                 | $10^{-14}$                        |           |
| 12 <sup>c</sup> | $6.18 \cdot 10^{-9}$              | $-3.03 \cdot 10^{-8}$             | $5.98 \cdot 10^{-5}$              |           |
| 12 <sup>d</sup> | $-1.38 \cdot 10^{-9}$             | $1.37 \cdot 10^{-8}$              | $1.45 \cdot 10^{-5}$              |           |
| 12 <sup>e</sup> | -                                 | -                                 | $1.15 \cdot 10^{-5}$              |           |
|                 | $D_1$ ( $^{\circ}\text{C}$ )      | $D_2$ (-)                         | $D_3$ ( $^{\circ}\text{C}^{-1}$ ) | $D_4$ (-) |
| 13 <sup>a</sup> | -7726.010                         | -14.50613                         | -0.02798420                       | 102.2755  |
| 14 <sup>a</sup> | -9137.258                         | -18.11192                         | -0.02245619                       | 116.7371  |

<sup>a</sup> The equation and parameters are reported by Kawazuishi and Prausnitz (1987)<sup>13</sup> for  $0 < T < 225^{\circ}\text{C}$ .  
<sup>b</sup> The dependence of temperature for this reaction is not introduced since it does not influence the final result significantly.  
<sup>c</sup> HAc = benzoic acid. Derived from data reported by Ketler *et al.* (1995).<sup>14</sup>  
<sup>d</sup> HAc = hexanoic acid. Derived from data reported by Kortüm *et al.* (1961).<sup>15</sup>  
<sup>e</sup> HAc = decanoic acid. Derived from data reported by Kortüm *et al.* (1961)<sup>15</sup> by extrapolation of dissociation constants for lower fatty acids ( $C_6 - C_9$ ); Since only the value at  $20^{\circ}\text{C}$  was used, no temperature dependence is introduced.

**Table A1.6** Pitzer's binary interaction parameters in equation (4-16).

| Parameter<br>(kg/mol)        | Electrolyte        |                          |                                    |                     |                     |
|------------------------------|--------------------|--------------------------|------------------------------------|---------------------|---------------------|
|                              | $\text{NaHCO}_3$   | $\text{Na}_2\text{CO}_3$ | $\text{C}_6\text{H}_5\text{COONa}$ | HCl                 | $\text{HNO}_3$      |
| $\beta_j^{(0)}$ <sup>a</sup> | 0.028 <sup>b</sup> | 0.0362 <sup>b</sup>      | 0.22 <sup>c</sup>                  | 0.1775 <sup>b</sup> | 0.1168 <sup>b</sup> |
| $\beta_j^{(1)}$ <sup>a</sup> | 0.044 <sup>b</sup> | 1.51 <sup>b</sup>        | 0.27 <sup>c</sup>                  | 0.2945 <sup>b</sup> | 0.3546 <sup>b</sup> |

<sup>a</sup> Parameters represent the interaction between corresponding cation and anion.  
<sup>b</sup> From Pitzer (1991)<sup>21</sup>.  
<sup>c</sup> Derived from data reported by Kilpatrick (1953).<sup>22</sup>

## Literature Cited

- (1) Ng, H. Robinson, D. B. Equilibrium Phase Properties of the Toluene-Carbon Dioxide System. *J. Chem. Eng. Data.* **1978**, *23*, 325-327.
- (2) Fink, S. D.; Hershey, H. S. Modeling the Vapor-Liquid Equilibria of 1,1,1-Trichloroethane + Carbon Dioxide and Toluene + Carbon Dioxide at 308, 323, and 353 K. *Ind. Eng. Chem. Res.* **1990**, *29*, 295-306.
- (3) Tan, C.; Yarn, S.; Hsu, J. Vapor-Liquid Equilibria for the System Carbon Dioxide-Ethylbenzene and Carbon Dioxide-Styrene. *J. Chem. Eng. Data.* **1991**, *36*, 23-25.
- (4) Sebastian, H. M.; Simnick, J. J.; Lin, H.; Chao, K. Gas-Liquid Equilibrium in Mixtures of Carbon Dioxide + Toluene and Carbon Dioxide + m-Xylene. *J. Chem. Eng. Data.* **1980**, *25*, 246-248.
- (5) Ohgaki, K.; Katayama, T. Isothermal Vapor-Liquid Equilibrium Data for Binary Systems Containing Carbon Dioxide at High Pressures: Methanol-Carbon Dioxide, n-Hexane-Carbon Dioxide, and Benzene-Carbon Dioxide Systems. *J. Chem. Eng. Data* **1976**, *21*, 53-55.
- (6) Reamer, H. H.; Sage, B. H. Phase Equilibria in Hydrocarbon Systems, Volumetric and Phase Behavior of the n-Decane-CO<sub>2</sub> System. *J. Chem. Eng. Data.* **1963**, *8*, 508-513.
- (7) Kim, C.; Clark, A. B.; Vimalchand, P.; Donohue, M. D. High-Pressure Binary Phase Equilibria of Aromatic Hydrocarbons with CO<sub>2</sub> and C<sub>2</sub>H<sub>6</sub>. *J. Chem. Eng. Data.* **1989**, *34*, 391-395.
- (8) Chen, J.; Lee, M. Vapor-Liquid Equilibria for Benzyl Alcohol with Carbon Dioxide, Ethane, or Nitrogen at Elevated Pressures. *Fluid Phase Equilibria* **1997**, *130*, 231-242.
- (9) Perry, R. H.; Green, D. *Perry's Chemical Engineers' Handbook*; McGraw-Hill: Singapore, 1984; pp. 3-45.
- (10) In *Handbook of Chemistry and Physics*; Lide, D. R., Ed.; CRC Press: London, 2002 ; pp.6-83, 6-84.
- (11) In *Solubilities of Inorganic and Organic Compounds, Binary Systems*; Stephen, H.; Stephen, T. Eds.; Pergamon Press: Oxford, 1963.
- (12) Ralston, A. W.; Hoerr, C. W. The Solubilities of the Normal Saturated Fatty Acids. *J. Org. Chem.* **1942**, *7*, 546-555.
- (13) Kawazuishi, K.; Prausnitz, J. M.; Correlation of Vapor-Liquid Equilibria for the System Ammonia-Carbon Dioxide-Water. *Ind. Eng. Chem. Res.* **1987**, *26*, 1482-1485.
- (14) Kettler, R. M.; Wesolowski, D. J.; Palmer, D. A. Dissociation Quotient of Benzoic Acid in Aqueous Sodium Chloride Media to 250°C. *J. Solution Chem.* **1995**, *24*, 385-407.
- (15) Kortüm, G.; Vogel, W.; Andrussov, K. *Dissociation Constants of Organic Acids in Aqueous Solution*; Butterworths: London, 1961; pp. 247
- (16) Hermann, C.; Dewes, I.; Schumpe, A. The Estimation of Gas Solubilities in Salt Solutions. *Chem. Eng. Sci.* **1995**, *50*, 1673-1675.
- (17) Duan, Z.; Sun, R. An Improved Model Calculating CO<sub>2</sub> Solubility in Pure Water and Aqueous NaCl Solutions from 273 to 533 K and from 0 to 2000 bar. *Chem. Geology.* **2003**, *193*, 257-271.
- (18) Sergeeva, V. F. Salting-out and Salting-In of Non-Electrolytes. *Russ. Chem. Rev.* **1965**, *34*, 309-318.
- (19) Long, F. A.; McDevit, W. F. Activity Coefficients of Nonelectrolyte Solutes in Aqueous Salt Solutions. *Chem. Rev.* **1952**, *51*, 119-160.
- (20) In *Solubilities of Inorganic and Organic Compounds, Ternary Systems*; Stephen, H.; Stephen, T. Eds.; Pergamon Press: Oxford, 1964.
- (21) Pitzer, K.S. Ion Interaction Approach: Theory and Data Correlation. In *Activity Coefficients in Electrolyte Solutions*; Pitzer, K. S., Ed.; CRC Press: London, 1991.
- (22) Kilpatrick, M. The Dissociation Constants of Acids in Salt Solutions. I. Benzoic Acid. *J. Am. Chem. Soc.* **1953**, *75*, 584-585.

## Appendix A2

# Case study – Energy requirements and associated costs for recovery process of toluene oxidation products

In this appendix the energy requirements (heat duties and work loads) and associated utility costs of the optimal reactive-extraction-based process and the reference distillation-based process are estimated for the recovery of toluene oxidation products as proposed in Chapter 6. This is done by identifying the main energy requirements in each process section (a section represents one box in the conceptual flowsheet) and calculating the heat duty and work load in each of them. Based on this, the utility costs are determined.

### A2.1 Design basis

The energy requirements are calculated for a process which would annually produce 30000 t of each product - benzyl alcohol, benzaldehyde and benzoic acid, whereas the conversion of toluene in the reactor is taken to be 5 wt%. The plant would operate 8000 h/a. The stream entering the separation train is assumed to be a liquid at the normal boiling point of toluene (110 °C) [this is the temperature of the reactor effluent, consisting mainly of toluene, after decreasing the reactor pressure to 1 bar]. The toluene recycle stream returning to the reactor should also be a liquid at 110 °C.

Sodium hydrogen sulphite ( $\text{NaHSO}_3$ ) is used as the extractant for benzaldehyde, and sodium chloride as the salting-out agent in the back-recovery of benzoic acid. For that back-recovery, carbon dioxide aided precipitation is applied.

In the extraction based process for the recovery of unmodified alcohol, hydroxypropyl- $\beta$ -cyclodextrin with an average molar substitution (AMS) of 0.6 is adopted as the extractant.

In addition, the following assumptions are adopted for this case study:

- Stream compositions are determined based on a 100% efficiency of each process section (a full recovery, complete separation, etc.) with no losses of chemicals;
- The physical properties (density, heat capacity, etc.) of a multicomponent liquid stream are considered to be the same as the physical properties of the pure solvent of that stream;

- The heat duty of a distillation is represented only by the duty required to evaporate the lightest boiling compound without reflux;
- The work load for fluid transport between the sections is neglected, except if there is a pressure difference between the sections;
- Heat integration is performed wherever possible;
- For the calculation of utility costs, the efficiency of the use of that utility is taken as 100%, i.e. there are no losses of energy. This means that the calculated duties and work loads are thermodynamically minimum;

Furthermore, the assumptions and conclusions already introduced in Chapter 6 are also adopted:

- NaHSO<sub>3</sub> and NaHCO<sub>3</sub> can coexist, but will partially transform into Na<sub>2</sub>SO<sub>3</sub> and H<sub>2</sub>CO<sub>3</sub>;
- No interaction of hydroxypropyl-cyclodextrin with benzaldehyde and benzoic acid exists;
- NaCl does not have any effect on other products but benzoic acid;
- No other interactions among extractants or effects of any added extractant on extraction or any back-recovery operation exist.

Finally, the list of used utilities and their costs is given in Table A2.1.

**Table A2.1** Used utilities and their costs.<sup>1</sup>

| Utility  | Cost (€/GJ) <sup>a</sup> |
|--|--------------------------|
| Low pressure steam (5 bar, 160 °C) from a boiler       | 7.15                     |
| High pressure steam (41 bar, 254 °C) from a boiler     | 9.04                     |
| Process cooling water (at 30 °C and returned at 40 °C) | 0.33                     |
| Electrical energy                                      | 15.4                     |
| Refrigeration water (at 5 °C and returned at 10 °C)    | 4.07                     |

<sup>a</sup>In the literature reference the costs are given in \$/GJ and an exchange rate of 1 € = 0.92 \$ is used for the conversion.

## A2.2 Reference distillation-based process

Assuming a 100% recovery of all products in each section, the flowrates in the reference distillation process are as given in Table A2.2. The flowsheet of this process is given in Figure 6.12.

The duty of this process is calculated as the sum of the evaporation duties necessary to evaporate the lightest boiling compound in each distillation section, plus the condensation duty needed to condense the toluene stream recycled to the oxidation reactor (stream 2 in Figure 6.12). Both, the evaporation and condensation duty, are calculated per ton of products produced as:

$$Q^{ev} = -Q^{con} = \frac{\dot{m}}{\dot{m}_P} \cdot \frac{\Delta H_{vap}}{M} \cdot 10^{-3} \quad (\text{A2-1})$$

where  $Q^{ev}$  is the evaporation and  $Q^{con}$  is the condensation duty in GJ/t,  $\dot{m}$  is the flowrate of the evaporated (condensed) compound and  $\dot{m}_P$  is the total production rate of all three products (equivalent to 90000 t/a in this case study), both in t/a,  $M$  is the molar mass of the

evaporated (condensed) compound in g/mol, and  $\Delta H_{vap}$  the heat of evaporation at normal boiling point in J/mol as given in Table A2.15.

**Table A2.2** Flowrates in the reference distillation-based process (flowsheet is given in Figure 6.12).

| Component \ Stream | $\dot{m}$ (kt·a <sup>-1</sup> ) |      |    |    |    |    |    |
|--------------------|---------------------------------|------|----|----|----|----|----|
|                    | 1                               | 2    | 3  | 4  | 5  | 6  | 7  |
| Toluene            | 1710                            | 1710 | -  | -  | -  | -  | -  |
| Benzyl alcohol     | 30                              | -    | 30 | -  | 30 | 30 | -  |
| Benzaldehyde       | 30                              | -    | 30 | 30 | -  | -  | -  |
| Benzoic acid       | 30                              | -    | 30 | -  | 30 | -  | 30 |
| Total              | 1800                            | 1710 | 90 | 30 | 60 | 30 | 30 |

The evaporation duty for each distillation section, as well as the condensation duty for condensation of the reactor recycle stream are calculated in Table A2.3. Furthermore, the utility costs for each item are also given. Therefore, the total utility costs for the distillation-based process are 4.8 M€/a.

**Table A2.3** Evaporation/condensation duties (per ton of products) and associated utility costs  $C_{ut}$  in the reference distillation-based process.

| Stream                    | Compound       | $\dot{m}$ (kt·a <sup>-1</sup> ) | $Q^{ev}$ (GJ/t) <sup>a</sup> | $C_{ut}$ (M€/a) |
|---------------------------|----------------|---------------------------------|------------------------------|-----------------|
| Evaporation <sup>b</sup>  |                |                                 |                              |                 |
| 2                         | Toluene        | 1710                            | 6.9                          | 4.4             |
| 4                         | Benzaldehyde   | 30                              | 0.1                          | 0.1             |
| 6                         | Benzyl alcohol | 30                              | 0.2                          | 0.1             |
| Condensation <sup>c</sup> |                |                                 |                              |                 |
| 2                         | Toluene        | 1710                            | - 6.9                        | 0.2             |

<sup>a</sup>The minus sign denotes cooling.

<sup>b</sup>Based on use of low pressure steam.

<sup>c</sup>Based on use of process cooling water.

## A2.3 Reactive extraction based process with monoesterification of benzyl alcohol

Based on the design basis constraints and assuming a 100% recovery of the products in each section, the flowrates in the reactive extraction based process with monoesterification of benzyl alcohol prior to the extraction are as given in Table A2.4. The accompanying flowsheet of this process is given in Figure 6.10.

The energy requirements in each section of this process are discussed below.

### A2.3.1 Monoesterification

This reaction can be performed at the same conditions as present in the oxidation reactor, assuming no effect on the oxidation reactions. Therefore, no additional energy requirements than that already provided for the toluene oxidation will be required.

**Table A2.4** Flowrates in the optimal extraction based process with prior monoesterification of benzyl alcohol (flowsheet is given in Figure 6.10).

| Component \ Stream                           | $\dot{m}$ (kt·a <sup>-1</sup> ) |                 |                 |                  |                 |      |                 |                 |                  |                 |                 |    |    |    |    |    |    |    |    |
|--|---------------------------------|-----------------|-----------------|------------------|-----------------|------|-----------------|-----------------|------------------|-----------------|-----------------|----|----|----|----|----|----|----|----|
|  | 1                               | 2               | 3               | 4                | 5               | 6    | 7               | 8               | 9                | 10              | 11              | 12 | 13 | 14 | 15 | 16 | 17 | 18 | 19 |
| Toluene                                      | 1710                            | -               | 1710            | -                | -               | 1710 | -               | -               | 315 <sup>p</sup> | -               | 315             | -  | -  | -  | -  | -  | -  | -  | -  |
| Benzyl alcohol                               | 30                              | -               | -               | -                | -               | -    | -               | -               | -                | -               | 30 <sup>o</sup> | -  | -  | -  | -  | -  | 30 | -  | 30 |
| Benzaldehyde                                 | 30                              | -               | 30              | -                | -               | -    | -               | -               | -                | -               | 30 <sup>o</sup> | -  | -  | -  | -  | -  | 30 | 30 | -  |
| Benzoic acid                                 | 30                              | -               | 30              | -                | -               | -    | -               | -               | -                | 30 <sup>r</sup> | -               | -  | 30 | 30 | -  | -  | -  | -  | -  |
| Water  | -                               | -               | -               | 482 <sup>k</sup> | -               | -    | 529             | 522             | -                | 35 <sup>s</sup> | -               | 35 | -  | -  | -  | 6  | -  | -  | -  |
| NaHCO <sub>3</sub>                           | -                               | -               | -               | 50 <sup>l</sup>  | -               | -    | 0 <sup>n</sup>  | 0               | -                | -               | -               | -  | -  | -  | -  | -  | -  | -  | -  |
| NaHSO <sub>3</sub>                           | -                               | -               | -               | 61 <sup>l</sup>  | -               | -    | 44 <sup>n</sup> | 61 <sup>o</sup> | -                | -               | -               | -  | -  | -  | -  | -  | -  | -  | -  |
| Na <sub>2</sub> SO <sub>3</sub> <sup>b</sup> | -                               | -               | -               | 19 <sup>b</sup>  | -               | -    | 19              | 19              | -                | -               | -               | -  | -  | -  | -  | -  | -  | -  | -  |
| CO <sub>2</sub>                              | -                               | -               | -               | 17 <sup>b</sup>  | 26 <sup>m</sup> | -    | 17              | 17              | -                | -               | -               | -  | -  | -  | -  | -  | -  | -  | -  |
| NaCl <sup>a</sup>                            | -                               | -               | -               | 30 <sup>a</sup>  | -               | -    | 30              | 30              | -                | -               | -               | -  | -  | -  | -  | -  | -  | -  | -  |
| Bisulphite adduct <sup>h</sup>               | -                               | -               | -               | -                | -               | -    | 47 <sup>n</sup> | -               | -                | -               | -               | -  | -  | -  | -  | -  | -  | -  | -  |
| Sodium benzoate                              | -                               | -               | -               | -                | -               | -    | 35 <sup>n</sup> | 35              | -                | -               | -               | -  | -  | -  | -  | -  | -  | -  | -  |
| Cyclic anhydride <sup>c</sup>                | -                               | 46 <sup>i</sup> | 11 <sup>j</sup> | -                | -               | -    | -               | -               | -                | -               | -               | -  | -  | -  | -  | -  | -  | -  | -  |
| Sodium salt of diacid <sup>d</sup>           | -                               | -               | -               | -                | -               | -    | 17 <sup>n</sup> | 67 <sup>o</sup> | -                | -               | -               | -  | -  | -  | -  | -  | -  | -  | -  |
| Dicarboxylic acid <sup>e</sup>               | -                               | -               | -               | -                | -               | -    | -               | -               | -                | 52 <sup>r</sup> | -               | -  | 52 | -  | -  | -  | -  | -  | -  |
| Monoester <sup>f</sup>                       | -                               | -               | 66 <sup>j</sup> | -                | -               | -    | -               | -               | -                | -               | -               | -  | -  | -  | -  | -  | -  | -  | -  |
| Monoester sodium salt <sup>g</sup>           | -                               | -               | -               | -                | -               | -    | 72 <sup>n</sup> | -               | -                | -               | -               | -  | -  | -  | -  | -  | -  | -  | -  |
| Total  | 1800                            | 46              | 1847            | 659              | 26              | 1710 | 810             | 751             | 315              | 117             | 375             | 35 | 82 | 30 | 52 | 6  | 60 | 30 | 30 |

## Table A2.3 Continued

- 
- <sup>a</sup> Sodium chloride at 1 mol/l is present to improve the back-recovery of benzoic acid (for details see Chapter 4).
- <sup>b</sup> When equimolar amounts of  $\text{NaHSO}_3$  and  $\text{NaHCO}_3$  are introduced together, around 25% of each will be converted into  $\text{Na}_2\text{SO}_3$  and into  $\text{CO}_2$  (for details see Chapter 6).
- <sup>c</sup> 3-methylglutaric anhydride.
- <sup>d</sup> Disodium salt of 3-methylglutaric acid (both carboxyl groups will dissociate in the presence of sodium hydrogen carbonate).
- <sup>e</sup> 3-methylglutaric acid.
- <sup>f</sup> Monobenzyl-3-methylglutarate.
- <sup>g</sup> Sodium monobenzyl-3-methylglutarate.
- <sup>h</sup> Sodium hydrogen sulphite adduct of benzaldehyde.
- <sup>i</sup> 30% molar excess of anhydride over benzyl alcohol is adopted.
- <sup>j</sup> Benzyl alcohol is completely converted into the monoester in a 1:1 reaction with the anhydride (for details see Chapter 5).
- <sup>k</sup> Very high distribution ratios of solutes (for details see Chapters 3, 4 and 5) allow the adoption of low solvent-to-feed ratios (S/F). However, sufficient sodium hydrogen carbonate has to be present in the aqueous phase to extract benzoic acid, monoester and the remaining dicarboxylic acid. Therefore, the solubility of  $\text{NaHCO}_3$  determines S/F. A value of 0.4 is adopted for S/F (as volume ratio). Furthermore, it is taken that the density of the aqueous salt solution is the same as that for pure water.
- <sup>l</sup> The concentration of both salts is adopted to be 1.1 mol/l (for which the amount of  $\text{NaHCO}_3$  will be sufficient at S/F=0.4).
- <sup>m</sup> This is  $\text{CO}_2$  generated by converting all benzoic acid into benzoate (for details see Chapter 4), all monoester into the monoester sodium salt and all dicarboxylic acid into its disodium salt.
- <sup>n</sup> All benzaldehyde is converted into hydrogen sulphite adduct in a 1:1 reaction with  $\text{NaHSO}_3$  (see Chapter 3), all benzoic acid into sodium benzoate in a 1:1 reaction with  $\text{NaHCO}_3$  (see Chapter 4), all monoester into monoester sodium salt in a 1:1 reaction with  $\text{NaHCO}_3$  and the remaining anhydride into the disodium salt of 3-methylglutaric acid in a 1:2 reaction with  $\text{NaHCO}_3$  (see Chapter 5).
- <sup>o</sup> All benzaldehyde (goes to stream 11) and sodium hydrogen sulphite are recovered from the hydrogen sulphite adduct, whereas the monoester is completely converted into benzyl alcohol (goes to stream 11) and the sodium salt of dicarboxylic acid.
- <sup>p</sup> S/F of 0.7 is adopted (as volume ratio).
- <sup>r</sup> All benzoic acid and 3-methylglutaric acid are recovered by precipitation.
- <sup>s</sup> Water is adopted to be present at 30 wt% before drying.
-

### A2.3.2 Reactive extraction

The extraction is performed at room temperature. Hence, stream 3 has to be cooled down to room temperature. However, since almost the same duty is required to heat the toluene recycle stream 6, heat integration of these two streams can be done such that no additional duty is required.

The extraction solvent (stream 4) is coming from the back-recovery at the temperature of precipitation and needs to be reheated to room temperature.

The heating (cooling) duty per ton of products produced is calculated as:

$$Q^{h/c} = \frac{\dot{m}}{\dot{m}_P} \cdot \frac{C_p \cdot (T_2 - T_1)}{M} \cdot 10^{-3} \quad (\text{A2-2})$$

where  $Q^{h/c}$  is the heating (cooling) duty (GJ/t) necessary to heat/cool a stream of flowrate  $\dot{m}$  (t/a) to change its temperature from  $T_1$  to  $T_2$  (°C).  $C_p$  is the specific heat capacity [J/(mol·°C)] as given in Table A2.17.

### A2.3.3 Back-extraction with temperature shift

The back-extraction is performed at a temperature higher than the forward-extraction, since a temperature shift is necessary to achieve back-recovery. Any higher temperature can be chosen and an optimum between the number of stages and the heat input has to be found. However, the maximum temperature at which it can be accomplished at atmospheric pressure is limited by the boiling point of water. Therefore, a temperature of 98 °C is selected as the temperature of back-extraction in this case study. So, stream 7 has to be heated from 25 to 98 °C. The solvent (stream 9) is at the boiling temperature of toluene (110 °C) and therefore does not need to be heated, but can provide some of the energy necessary for heating stream 7. Both the duty required for heating stream 7 and the one for cooling stream 9, are calculated using equation A2-2.

### A2.3.4 Precipitation and filtration

For the back-recovery of benzoic acid by precipitation the optimal temperature and pressure have to be determined, in the evaluated range of 5 - 25 °C and 5 - 50 bar. For this study, we assume the precipitation to be performed at 10 °C and 30 bar. Therefore, stream 8 needs to be cooled from the temperature of back-extraction (98 °C) to 10 °C and pumped into the vessel at 30 bar. Similarly, cooling and compression of carbon dioxide stream 5 has to be done. The precipitation and filtration could be accomplished in a unit similar to the rotary filter drum, in which the liquid will be under pressure of carbon dioxide. This will cause precipitation, whereas the pressure difference between two sides of the drum will provide filtration. In that case, the liquid will stay under pressure and only the carbon dioxide spent for conversion of sodium benzoate into benzoic acid and disodium-3-methylglutarate into 3-methylglutaric acid has to be provided. Hence, for full recovery the amount of carbon dioxide that needs to be compressed is equal to that generated in the extraction section (stream 5). Therefore, the total energy input required for this section is connected to cooling streams 8 and 5, to transporting liquid stream 8 and compressing gaseous stream 5 from 1 bar to 30 bar.

The power required for the gas compression  $P^{com}$  (kW) is calculated from the frictionless adiabatic work  $W$  (J/mol) necessary to compress the fluid from pressure  $p_1$  to pressure  $p_2$  (Pa) assuming ideal gas behaviour:



$$P^{com} = W \cdot \frac{\dot{m}}{M} \cdot \frac{10^3}{8000 \cdot 3600} = \left\{ \frac{k}{k-1} \cdot R \cdot T_1 \left[ \left( \frac{p_2}{p_1} \right)^{\frac{k-1}{k}} - 1 \right] \right\} \cdot \frac{\dot{m}}{M} \cdot \frac{10^3}{8000 \cdot 3600} \quad (\text{A2-3})$$

where  $k$  is the ratio of heat capacities at constant pressure and constant volume ( $k = 1.3$  for  $\text{CO}_2$ ),  $T_1$  (K) is the temperature at pressure  $p_1$ .

The power  $P^{pump}$  (kW) for liquid transport from pressure  $p_1$  to pressure  $p_2$  is calculated from the mechanical energy balance:

$$P^{pump} = \left[ \left( \frac{p_2}{\rho_2} - \frac{p_1}{\rho_1} \right) \right] \cdot \dot{m} \cdot \frac{1}{8000 \cdot 3600} \quad (\text{A2-4})$$

where  $\rho_1$  and  $\rho_2$  are the fluid densities ( $\text{kg/m}^3$ ) at temperature  $T_1$  and  $T_2$ , respectively.

The work load per ton of products produced for gas compression and liquid transport  $W^{com,pump}$  (GJ/t) is then calculated as:

$$W^{com,pump} = P^{com,pump} \cdot \frac{1}{\dot{m}_P} \cdot \frac{8000 \cdot 3600}{10^6} \quad (\text{A2-5})$$

Again, equation (A2-2) is used to calculate the heat duty required for cooling the streams 8 and 5. The temperature (in K) from which the compressed stream 5 has to be cooled, assuming one stage compression with cooling, is calculated from the equation:

$$T_2 = T_1 \cdot \left( \frac{p_2}{p_1} \right)^{\frac{k-1}{k}} \quad (\text{A2-6})$$

### A2.3.5 Drying

Water has to be removed from the precipitate containing 3-methylglutaric acid and benzoic acid. This requires evaporation of the water present in stream 10, and the duty is calculated using equation (A2-1).

### A2.3.6 Solids separation

Separation of 3-methylglutaric acid and benzoic acid is achieved by melting the lower boiling acid (in this case 3-methylglutaric acid) and separating the formed liquid from the solid benzoic acid. This requires heating of stream 13 to the melting point of 3-methylglutaric acid (84 °C) and complete melting of this acid. Since the duty required for melting is much higher than the sensible heat, only the melting duty will be quantified:

$$Q^{melt} = \frac{\dot{m}}{\dot{m}_P} \cdot \frac{\Delta H_{melt}}{M} \cdot 10^{-3} \quad (\text{A2-7})$$

where  $Q^{melt}$  is the melting duty in GJ/t,  $\Delta H_{melt}$  is the heat of melting in J/mol as given in Table A2.16.

### A2.3.7 Anhydride regeneration

Generation of a cyclic anhydride from its dicarboxylic acid requires its heating up to temperatures of 150 - 250 °C. This asks for heating stream 15 from the temperature of solids separation to the regeneration temperature, which is adopted in this study to be 200 °C. Equation (A2-2) is used to quantify this duty.

### A2.3.8 Distillation

As in the reference distillation-based process, the energy requirements in distillation are based on the energy necessary to evaporate the lightest boiling compound. They are calculated for streams 9 and 18 using equation (A2-1).

All heating/cooling duties in the extraction-based process are calculated and given in Table A2.4. However, the utility costs associated with heating/cooling have to be determined after implementation of heat integration. As already mentioned, the energy of stream 3 is used to heat stream 6. Streams 9 and 8 can partially heat stream 7. Furthermore, stream 4 can further cool stream 8. Therefore, the net heating/cooling duties, assuming no energy losses, and associated utility costs are as shown in Table A2.5.

**Table A2.4** Heating/cooling duty for each stream that needs to be heated/cooled in the extraction-based process with monoesterification.

| Stream | T <sub>1</sub> (°C) | T <sub>2</sub> (°C) | $\dot{m}$ (kt·a <sup>-1</sup> ) | Q <sup>h/c</sup> (GJ/t) <sup>b</sup> |
|--------|---------------------|---------------------|---------------------------------|--------------------------------------|
| 3      | 110                 | 25                  | 1847                            | - 3.0 <sup>c</sup>                   |
| 4      | 10                  | 25                  | 659                             | 0.5 <sup>d</sup>                     |
| 5      | 367 <sup>a</sup>    | 10                  | 26                              | - 0.1                                |
| 6      | 25                  | 110                 | 1710                            | 2.8                                  |
| 7      | 25                  | 98                  | 810                             | 2.8 <sup>d</sup>                     |
| 8      | 98                  | 10                  | 751                             | - 3.1 <sup>d</sup>                   |
| 9      | 110                 | 98                  | 315                             | - 0.1                                |
| 15     | 84                  | 200                 | 52                              | 0.1                                  |

<sup>a</sup>This would be the temperature if the compression would be done in one stage. In practice, the compression will be done in several stages of compression and intermediate cooling. However, this value allows a rough estimation of the energy required for cooling.

<sup>b</sup>The minus sign denotes cooling.

<sup>c</sup>Based on the heat capacity of pure toluene.

<sup>d</sup>Based on the heat capacity of pure water.

**Table A2.5** Heating/cooling duties after heat integration and associated utility costs in the reactive extraction based process with monoesterification.

| Stream | T <sub>1</sub> (°C) | T <sub>2</sub> (°C) | $\dot{m}$ (kt·a <sup>-1</sup> ) | Q <sup>h/c</sup> (GJ/t) <sup>c</sup> | C <sub>ut</sub> (M€/a) |
|--------|---------------------|---------------------|---------------------------------|--------------------------------------|------------------------|
| 5      | 367 <sup>a</sup>    | 10                  | 26                              | - 0.1                                | 0.0 <sup>e</sup>       |
| 7      | 63 <sup>b</sup>     | 98                  | 810                             | 1.3 <sup>d</sup>                     | 0.8 <sup>f</sup>       |
| 8      | 48 <sup>b</sup>     | 10                  | 751                             | - 1.3 <sup>d</sup>                   | 0.3 <sup>e</sup>       |
| 15     | 98 <sup>b</sup>     | 200                 | 52                              | 0.1                                  | 0.1 <sup>g</sup>       |

<sup>a</sup>This would be the temperature if compression would be done in one stage. In practice, the compression will be done in several stages of compression and intermediate cooling. However, this value allows a rough estimation of the energy required for cooling. This stream is not included in heat integration.

<sup>b</sup>Stream 7 heated by streams 8, 9 and 15. Stream 8 cooled by stream 7 and stream 4.

<sup>c</sup>Minus sign denotes cooling.

<sup>d</sup>Based on the heat capacity of pure water.

<sup>e</sup>Till 30 °C cooled by process cooling water, and from 30 to 10 °C cooled by refrigerated water.

<sup>f</sup>Heated by low pressure steam (5 bar, 160 °C).

<sup>g</sup>Heated by high pressure steam (41 bar, 254 °C).

The required work loads for compression and liquid transport and associated utility costs are given in Table A2.6.

**Table A2.6** Work load for compression and liquid transport in the precipitation section of the extraction based process with monoesterification and associated utility costs.

| Stream | (kt·a <sup>-1</sup> ) | P (kW) | $W^{com,pump}$ (GJ/t) | $C_{ut}$ (M€/a) <sup>a</sup> |
|--------|-----------------------|--------|-----------------------|------------------------------|
| 5      | 26                    | 248    | 0.1                   | 0.1                          |
| 8      | 751                   | 76     | 0.0                   | 0.0                          |

<sup>a</sup> Based on the use of electrical energy.

The evaporation and melting duties and associated utility costs are given in Table A2.7.

**Table A2.7** Evaporation and melting duties and associated utility costs in the extraction based process with monoesterification.

| Stream                   | Compound              | $\dot{m}$ (kt·a <sup>-1</sup> ) | $Q^{ev}$ (GJ/t) | $C_{ut}$ (M€/a) |
|--------------------------|-----------------------|---------------------------------|-----------------|-----------------|
| Evaporation <sup>a</sup> |                       |                                 |                 |                 |
| 9                        | Toluene               | 315                             | 1.3             | 0.8             |
| 12                       | Water                 | 35                              | 0.9             | 0.6             |
| 18                       | Benzaldehyde          | 30                              | 0.1             | 0.1             |
| Melting <sup>a</sup>     |                       |                                 |                 |                 |
| 15                       | 3-methylglutaric acid | 52                              | 0.1             | 0.1             |

<sup>a</sup> Based on the use of low pressure steam.

Finally, Table A2.8 summarises all utility costs of this extraction-based process classified by type of unit operation.

**Table A2.8** Summary of utility costs in the extraction based process with monoesterification of benzyl alcohol.

| Operation                      | $C_{ut}$ (M€/a) |
|--------------------------------|-----------------|
| Heating                        | 0.9             |
| Cooling                        | 0.3             |
| Compression / liquid transport | 0.1             |
| Evaporation                    | 1.5             |
| Melting                        | 0.1             |
| TOTAL                          | 2.9             |

## A2.4 Reactive extraction based process with recovery of unmodified benzyl alcohol

Based on the design basis constraints and assuming a 100% recovery of the products in each section (unit operation), the flowrates in the reactive extraction based process with recovery of the unmodified benzyl alcohol are as given in Table A2.9. The flowsheet of this process is given in Figure 6.9.

**Table A2.9.** Flowrates in the reactive extraction based process with extraction of unmodified benzyl alcohol (flowsheet is given in Figure 6.9).

| Component \ Stream              | $\dot{m}$ (kt·a <sup>-1</sup> ) |                   |      |                 |                  |                 |                 |    |                 |                  |                 |    |    |    |
|---------------------------------|---------------------------------|-------------------|------|-----------------|------------------|-----------------|-----------------|----|-----------------|------------------|-----------------|----|----|----|
|                                 | 1                               | 2                 | 3    | 4               | 5                | 6               | 7               | 8  | 9               | 10               | 11              | 12 | 13 | 14 |
| Toluene                         | 1710                            | -                 | 1710 | -               | -                | -               | -               | -  | -               | 630 <sup>o</sup> | 630             | -  | -  | -  |
| Benzyl alcohol                  | 30                              | -                 | -    | -               | -                | -               | -               | -  | -               | -                | 30 <sup>p</sup> | 30 | 30 | -  |
| Benzaldehyde                    | 30                              | -                 | -    | -               | -                | -               | -               | -  | -               | -                | 30 <sup>p</sup> | 30 | -  | 30 |
| Benzoic acid                    | 30                              | -                 | -    | -               | -                | -               | 30              | -  | 30 <sup>n</sup> | -                | -               | -  | -  | -  |
| Water                           | -                               | 1033 <sup>f</sup> | -    | -               | 1050             | 1033            | 13 <sup>i</sup> | 13 | -               | -                | -               | -  | -  | -  |
| HP-CD <sup>a</sup>              | -                               | 305 <sup>g</sup>  | -    | -               | 76 <sup>k</sup>  | 76              | -               | -  | -               | -                | -               | -  | -  | -  |
| NaHCO <sub>3</sub>              | -                               | 73 <sup>h</sup>   | -    | -               | 44 <sup>l</sup>  | 73 <sup>n</sup> | -               | -  | -               | -                | -               | -  | -  | -  |
| NaHSO <sub>3</sub>              | -                               | 89 <sup>h</sup>   | -    | -               | 72 <sup>m</sup>  | 72              | -               | -  | -               | -                | -               | -  | -  | -  |
| Na <sub>2</sub> SO <sub>3</sub> | -                               | 28 <sup>b</sup>   | -    | -               | 28               | 28              | -               | -  | -               | -                | -               | -  | -  | -  |
| CO <sub>2</sub>                 | -                               | 25 <sup>b</sup>   | -    | 11 <sup>j</sup> | 25               | 25              | -               | -  | -               | -                | -               | -  | -  | -  |
| NaCl                            | -                               | 30 <sup>c</sup>   | -    | -               | 30               | 30              | -               | -  | -               | -                | -               | -  | -  | -  |
| Bisulphite adduct <sup>d</sup>  | -                               | -                 | -    | -               | 47 <sup>m</sup>  | 47              | -               | -  | -               | -                | -               | -  | -  | -  |
| Sodium benzoate                 | -                               | -                 | -    | -               | 44 <sup>l</sup>  | -               | -               | -  | -               | -                | -               | -  | -  | -  |
| Alcohol-CD complex <sup>e</sup> | -                               | -                 | -    | -               | 259 <sup>k</sup> | 259             | -               | -  | -               | -                | -               | -  | -  | -  |
| Total                           | 1800                            | 1583              | 1710 | 11              | 1675             | 1643            | 43              | 13 | 30              | 630              | 690             | 60 | 30 | 30 |

<sup>a</sup> Hydroxypropyl- $\beta$ -cyclodextrin (AMS = 0.6).

<sup>b</sup> When equimolar amounts of NaHSO<sub>3</sub> and NaHCO<sub>3</sub> are introduced together, around 25% of each will be converted into Na<sub>2</sub>SO<sub>3</sub> and into CO<sub>2</sub> (for details see Chapter 6).

<sup>c</sup> Sodium chloride at 1 mol/l concentration is present to improve the back-recovery of benzoic acid (for details see Chapter 4).

<sup>d</sup> Sodium hydrogen sulphite adduct of benzaldehyde.

<sup>e</sup> Complex generated by interaction of benzyl alcohol and hydroxypropyl-cyclodextrin.

<sup>f</sup> Due to moderate distribution ratio of benzyl alcohol (for details see Chapter 5), not too low solvent-to-feed ratios (S/F) can be adopted. A two times higher value relative to the extraction with monoesterification is adopted for this case study (S/F = 0.8, as volume ratio). However, this value should not be applied in a process without further evaluation whether it can ensure extraction in reasonable size equipment. It is taken that the density of this stream is the same as the density of pure water.

<sup>g</sup> Concentration of cyclodextrin is taken to be 0.2 mol/l (see Chapter 5).

<sup>h</sup> Concentration for both salts is adopted to be 0.8 mol/l (see Chapters 3 and 4).

<sup>i</sup> Water is adopted to be present at 30 wt% before drying.

<sup>j</sup> The CO<sub>2</sub> generated by converting all benzoic acid into benzoate (for details see Chapter 4).

<sup>k</sup> All benzyl alcohol is converted into a complex with cyclodextrin in an assumed 1:1 reaction.

<sup>l</sup> All benzoic acid is converted into sodium benzoate in a 1:1 reaction with NaHCO<sub>3</sub>.

<sup>m</sup> All benzaldehyde is converted into a hydrogen sulphite adduct in a 1:1 reaction with NaHSO<sub>3</sub>.

<sup>n</sup> All benzoic acid is back-recovered from sodium benzoate, regenerating sodium hydrogen carbonate as well.

<sup>o</sup> S/F of 0.7 is adopted (volume ratio).

<sup>p</sup> All benzaldehyde and benzyl alcohol are back-recovered from the hydrogen sulphite adduct and complex with cyclodextrin.

Almost all utility consumers of this process are already discussed in Section A2.3. The only difference is that in the process with monoesterification more consumers are present. In the unmodified alcohol process there is no need for melting and heating of dicarboxylic acid. Based on the same temperatures selected for extraction (25 °C), back-extraction (98 °C) and

precipitation (10 °C at 30 bar), the calculated duties and associated utility costs are given in Tables A2.10 - A2.13. Again, the utility costs associated with heating/cooling are determined after implementation of heat integration.

**Table A2.10** Heating/cooling duty for each stream that needs to be heated/cooled in the extraction based process with recovery of unmodified alcohol.

| Stream | T <sub>1</sub> (°C) | T <sub>2</sub> (°C) | $\dot{m}$ (kt·a <sup>-1</sup> ) | Q <sup>h/c</sup> (GJ/t) <sup>b</sup> |
|--------|---------------------|---------------------|---------------------------------|--------------------------------------|
| 1      | 110                 | 25                  | 1800                            | - 2.9 <sup>c</sup>                   |
| 2      | 98                  | 25                  | 1583                            | - 5.4 <sup>d</sup>                   |
| 3      | 25                  | 110                 | 1710                            | 2.8                                  |
| 4      | 367 <sup>a</sup>    | 10                  | 11                              | 0.0                                  |
| 5      | 25                  | 10                  | 1675                            | - 1.2 <sup>d</sup>                   |
| 6      | 10                  | 98                  | 1643                            | 6.7 <sup>d</sup>                     |
| 10     | 110                 | 98                  | 630                             | -0.1                                 |

<sup>a</sup>This would be the temperature if the compression would be done in one stage. In practice, the compression will be done in several stages of compression and intermediate cooling. However, this value allows a rough estimation of the energy required for cooling.

<sup>b</sup>The minus sign denotes cooling.

<sup>c</sup>Based on the heat capacity of pure toluene.

<sup>d</sup>Based on the heat capacity of pure water.

**Table A2.11** Heating/cooling duties after heat integration and associated utility costs in the reactive extraction based process with recovery of unmodified alcohol.

| Stream | T <sub>1</sub> (°C) | T <sub>2</sub> (°C) | $\dot{m}$ (kt·a <sup>-1</sup> ) | Q <sup>h/c</sup> (GJ/t) <sup>c</sup> | C <sub>ut</sub> (M€/a) |
|--------|---------------------|---------------------|---------------------------------|--------------------------------------|------------------------|
| 2      | 58 <sup>a</sup>     | 25                  | 1583                            | - 2.4 <sup>d</sup>                   | 0.2 <sup>e</sup>       |
| 4      | 367 <sup>b</sup>    | 10                  | 11                              | - 0.0                                | 0.0 <sup>e</sup>       |
| 5      | 18                  | 10                  | 1675                            | - 1.2 <sup>d</sup>                   | 0.4 <sup>e</sup>       |
| 6      | 58 <sup>a</sup>     | 98                  | 1643                            | 3.1 <sup>d</sup>                     | 2.0 <sup>f</sup>       |

<sup>a</sup>Stream 6 heated by streams 5,10 and 2. Stream 2 cooled by stream 6. Streams 1 and 3 heat/cool each other.

<sup>b</sup>This would be the temperature if compression would be done in one stage. In practice, the compression will be done in several stages of compression and intermediate cooling. However, this value allows a rough estimation of the energy required for cooling. However, this stream is not included in heat integration.

<sup>c</sup>Minus sign denotes cooling.

<sup>d</sup>Based on the heat capacity of pure water.

<sup>e</sup>Till 30 °C cooled by process cooling water, and from 30 °C to T<sub>2</sub> cooled by refrigerated water.

<sup>f</sup>Heated by low pressure steam (5 bar, 160 °C).

**Table A2.12** Work load for compression and liquid transport in the precipitation section of the extraction based process with recovery of unmodified alcohol.

| Stream | $\dot{m}$ (kt·a <sup>-1</sup> ) | P (kW) | W <sup>com,pump</sup> (GJ/t) | C <sub>ut</sub> (M€/a) <sup>a</sup> |
|--------|---------------------------------|--------|------------------------------|-------------------------------------|
| 4      | 11                              | 105    | 0.0                          | 0.0                                 |
| 5      | 1675                            | 170    | 0.1                          | 0.1                                 |

<sup>a</sup>Based on the use of electrical energy.

**Table A2.13** Evaporation duties and associated utility costs in the extraction based process with recovery of unmodified alcohol.

| Stream | Compound     | $\dot{m}$ (kt·a <sup>-1</sup> ) | $Q^{ev}$ (GJ/t) | $C_{ut}$ (M€/a) |
|--------|--------------|---------------------------------|-----------------|-----------------|
| 8      | Water        | 13                              | 0.3             | 0.2             |
| 10     | Toluene      | 630                             | 2.5             | 1.6             |
| 14     | Benzaldehyde | 30                              | 0.1             | 0.1             |

<sup>a</sup>Based on use of low pressure steam.

Table A2.14 summarises all utility costs of this extraction based process classified by the type of unit operation.

**Table A2.14** Summary of utility costs in the extraction based process with recovery of unmodified benzyl alcohol.

| Operation                      | $C_{ut}$ (M€/a) |
|--------------------------------|-----------------|
| Heating                        | 2.0             |
| Cooling                        | 0.6             |
| Compression / liquid transport | 0.1             |
| Evaporation                    | 1.9             |
| TOTAL                          | 4.6             |

## A2.5 Physical parameters

**Table A2.15** Heat of evaporation at normal boiling point.

| Compound       | $\Delta H_{vap}$ (kJ·mol <sup>-1</sup> ) | $T_b$ (°C) | Reference |
|----------------|--|------------|-----------|
| Toluene        | 33.2                                     | 110.6      | 2         |
| Benzaldehyde   | 42.5                                     | 179.0      | 2         |
| Benzyl alcohol | 50.5                                     | 205.3      | 2         |
| Water          | 40.7                                     | 100.0      | 2         |

**Table A2.17** Specific heat capacity of heated/cooled compounds.

| Compound              | $C_p$ (J·mol <sup>-1</sup> ·°C <sup>-1</sup> ) | T (°C) | Reference |
|-----------------------|--|--------|-----------|
| Toluene               | 157.3  | 25     | 2         |
| Water                 | 75.4   | 10     | 2         |
|                       | 76.0   | 100    | 2         |
| Carbon dioxide        | 36.6   | 7      | 4         |
|                       | 37.1   | 25     | 4         |
| 3-Methylglutaric acid | 188.1 <sup>a</sup>                             | 25     | 2         |

<sup>a</sup>No data on the heat capacity for liquid 3-methylglutaric acid is found in the literature. Therefore, as the best approximation, the value for glutaric acid is adopted (the molecular structure and the melting point are similar).

**Table A2.16** Heat of melting at normal melting point.

| Compound              | $\Delta H_{\text{fus}}$ (kJ·mol <sup>-1</sup> ) | T <sub>m</sub> (°C) | Reference |
|-----------------------|---|---------------------|-----------|
| 3-Methylglutaric acid | 20.7 <sup>a</sup>                               | 84                  | 3         |

<sup>a</sup> No data on the heat of fusion for 3-methylglutaric acid is found in the literature. Therefore, as the best approximation, the value for glutaric acid is adopted (the molecular structure and the melting point are similar).

## Literature Cited

- (1) Turton, R.; Bailie, R. C.; Whiting, W. B.; Shaeiwitz, J. A. *Analysis, Synthesis, and Design of Chemical Processes*. Prentice Hall: London, 2003.
- (2) In *Handbook of Chemistry and Physics*; Lide, D. R., Ed.; CRC Press: London, 2002.
- (3) *Physical and Thermodynamical Properties of Pure Chemicals. Evaluated Process Design Data. Part 3*. Greyden Press: Columbus, 1999.
- (4) Angus, S.; Armstrong, B.; de Reuck, K. M. *Carbon Dioxide. Industrial Thermodynamic Tables of the Fluid State – 3*. Pergamon Press: 1976.





