

REVIEWS

Kinetics of the Low-Temperature Pyrolysis of Polyethene, Polypropene, and Polystyrene Modeling, Experimental Determination, and Comparison with Literature Models and Data

R. W. J. Westerhout, J. Waanders, J. A. M. Kuipers,* and W. P. M. van Swaaij

Faculty of Chemical Engineering, Reaction Engineering Group, University of Twente, P.O. Box 217, 7500 AE Enschede, The Netherlands

The pyrolysis kinetics of low-density polyethylene, high-density polyethylene, polypropylene, and polystyrene has been studied at temperatures below 450 °C. In addition, a literature review on the low-temperature pyrolysis of these polymers has been conducted and has revealed that the scatter in the reported kinetic data is significant, which is most probably due to the use of simple first-order kinetic models to interpret the experimental data. This model type is only applicable in a small conversion range, but was used by many authors over a much wider conversion range. In this investigation the pyrolysis kinetics of the forementioned polymers and a mixture of polymers has been studied at temperatures below 450 °C by performing isothermal thermogravimetric analysis (TGA) experiments. The TGA experimental data was used to determine the kinetic parameters on the basis of a simple first-order model for high conversions (70–90%) and a model developed in the present study, termed the random chain dissociation (RCD) model, for the entire conversion range. The influence of important parameters, such as molecular weight, extent of branching and β -scission on the pyrolysis kinetics was studied with the RCD model. This model was also used to calculate the primary product spectrum of the pyrolysis process. The effect of the extent of branching and the initial molecular weight on the pyrolysis process was also studied experimentally. The effect of the extent of branching was found to be quite significant, but the effect of the initial molecular weight was minor. These results were found to agree quite well with the predictions obtained from the RCD model. Finally, the behavior of mixtures of the aforementioned polymers was studied and it was found that the pyrolysis kinetics of the polymers in the mixture remains unaltered in comparison with the pyrolysis kinetics of the pure polymers.

1. Introduction

In the Netherlands alone some 780 kton mixed plastic waste (MPW) is produced every year (Rijkema *et al.* (1992)). This waste is mainly produced by households (580 kton/yr) and is generally present in mixed state with other materials such as metals, glass, etc. The MPW consists mainly of four polymers: polyethene (PE), polypropene (PP), polystyrene (PS), and poly(vinyl chloride) (PVC). Until recently, the MPW was dumped or incinerated together with other household waste, but these disposal options will be or are forbidden in some countries and it is believed that other western European countries, the U.S., and Japan will follow these examples. This is the reason why many companies and universities are conducting research to develop alternative disposal methods for MPW. One of the most promising options is the high-temperature pyrolysis of MPW. By using this method, valuable chemicals like ethene, propene, butene, and styrene can be produced from this waste, which subsequently can be used to produce new polymers or can be sold for other purposes. Some high-temperature processes were developed in the past (Sinn *et al.* (1974, 1976), Batelle Memorial Institute (1992)), but were never commercialized due to the absence of sufficient economic, environmental, and political incentives on one hand and operational problems (removal of chlorine) on the other hand. These

reactors were developed empirically, because reliable data (hydrodynamics, heat transfer, and kinetics) required to develop these reactors on a fundamental basis was not available. The lack of fundamental data hampers the optimal design and operation of pyrolysis reactors.

The aim of this study is the experimental determination of kinetic data for the pyrolysis of PE, PP, and PS. For this purpose isothermal TGA experiments were performed. In addition a thorough literature study on the pyrolysis kinetics of PS, PP, and PE was conducted to provide a reference basis.

2. Literature Review

2.1. Introduction. Many authors have studied the pyrolysis kinetics of PE, PP, and PS, but unfortunately no systematic review of this data is available in the literature. Only Suuberg *et al.* (1978) have presented a review with a limited scope on this subject. In most studies a standard power law model has been used to describe the pyrolysis kinetics of the aforementioned polymers:

$$\frac{\partial m}{\partial t} = -k_0 e^{(-E_{act}/RT)} m^n = -K m^n \quad (1)$$

which can be converted into the following equation,

$$\frac{\partial \xi}{\partial t} = k_0 e^{-E_{\text{act}}/RT} (1 - \xi)^n = k(1 - \xi)^n \quad (2)$$

For a first-order reaction the preexponential constant is the same in both equations, but this quantity differs for orders deviating from unity.

In almost all studies, standard TGA (thermogravimetric analyzer) equipment was used for the experiments, which were performed at temperatures below 450 °C. The main difference between the studies was that some employed isothermal methods, while others employed nonisothermal methods.

2.2. Literature Models for the Description of the Kinetics of PE and PP. The main advantage of the power law model is that it is very easy to use, which explains its frequent use, but this model is not able to describe all the phenomena observed in kinetic experiments. Because of this reason, several other models besides the power law model were developed and published in the literature to describe the kinetics. The main drawback of these models is their complexity, which makes application of these models for practical purposes sometimes very difficult. These models can be used for either PE or PP, because the pyrolysis mechanisms are very similar. The models are described briefly in this section.

Infinite Number of Parallel Reactions Model. This model, used by Darivakis *et al.* (1990), assumes that the polymer degrades *via* an infinite number of parallel first-order reactions, while the activation energy distribution of these reactions is described by a Gaussian distribution. The preexponential constant of all reactions is assumed to be equal to 10^{13} s^{-1} , which is a typical value for thermal degradation reactions of hydrocarbons. For PE an average activation energy of 208 kJ/mol was found.

The Weak Bond Model. (Oakes and Richards (1949)). According to this type of model, the pyrolysis of polymers is characterized by a fast conversion rate at low conversions and a slow conversion rate at high conversions. Oakes and Richards (1949) explained this by assuming weak and normal bonds in the polymer chain, which are broken at a different rate (first-order kinetic model for each bond type), whereby weak bonds have a higher breakage rate than that of normal bonds. In this model, the number of weak bonds was assumed to be a function of temperature, which is physically not realistic. The number of fit parameters in this model is five.

Consecutive Reaction Models. Recently two consecutive reaction models with lumped product representation (gas, activated polymer, oil, and coal), were published by Koo and Kom (1993) and Conesa *et al.* (1994). The main drawback of this type of model is the high number of fit parameters, which are extremely difficult to determine accurately in practice and to which only a limited physical significance can be attributed. Even negative activation energies are reported for some reactions, which is highly unlikely.

Simha and Wall Model. This model type (Simha *et al.* (1950), Simha and Wall (1951, 1952), Montroll and Simha (1940)) can be considered as a depolymerization model in which initiation, propagation (hydrogen abstraction and β -scission), and termination reactions are accounted for. It is assumed that only very small product fragments can leave the polymer sample due to evaporation. Each product fragment with a certain length is treated as a separate product (no lumping of products) for which a mass balance is formulated. For certain limiting cases analytical representations of the

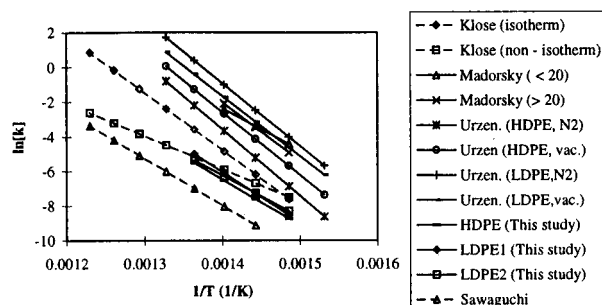

Figure 1. Arrhenius plot for first-order kinetic constants for PE found in literature.

pyrolysis kinetics can be obtained. The main advantage of this model is the accurate description of the pyrolysis reaction in great detail. The main drawback of the model is the large number of fit parameters employed (eight). Wall *et al.* (1954) were among the few who applied this model to describe the pyrolysis of PE.

The main fact recognized by the consecutive reaction models and the Simha and Wall model is the fact that the pyrolysis process of the polymers is very complex. By using apparatus such as a TGA in kinetic studies, in fact the evaporation rate of products is determined and not the intrinsic chemical reaction rate, since not every broken bond leads to the evaporation of a product, only product fragments which are small enough to evaporate will actually evaporate and thus lead to a decrease of the polymer mass.

2.3. Kinetic Parameters for PE Pyrolysis and Models for PE and PP Pyrolysis. The kinetic parameter values reported in literature for the pyrolysis of PE are summarized in Table 1. Only the studies, which used the power law model to describe the pyrolysis kinetics of PE, are listed in this table. From this table it can be seen that, depending on the degree of conversion, different reaction orders are obtained (*i.e.*, zero-order at low conversions and first-order at high conversions) and as a consequence, the kinetic constants differ significantly over the conversion range.

While the deviation in the reported kinetic constants (*i.e.*, the preexponential constant k_0 and the activation energy E_{act}) is large, this does not necessarily imply that the reported rate constants k also differ significantly. To compare the first-order k values, the k_0 and E_{act} values listed in Table 1 were used to produce the Arrhenius plot shown in Figure 1. In this plot only the results of studies, which used the first order power law model are shown.

It is evident from Figure 1 that the reported kinetic constants differ by a factor of 10, even if measurements in which mass or heat transfer limitations occurred (*i.e.*, Klose (1972)) are eliminated. The observed differences can be due to the use of different types of PE, the influence of molecular weight and measurement errors. However, the use of the simple power law model over a large conversion is most probably the most important reason for the observed differences.

2.4. Kinetic Parameters for the Pyrolysis of PP Reported in Literature. The number of authors, who published kinetic data for the pyrolysis of PP, is not as large as for PE. The models used to describe the pyrolysis kinetics of PP are basically the same as those used for PE. The kinetic parameter values reported in the literature for the power law kinetic model are summarized in Table 2. Davis *et al.* (1962) were among one of the few authors who used both the weak bond model and the Simha and Wall model to interpret their

Table 1. Kinetic Parameters for the Pyrolysis of PE Reported in the Literature

| authors | T (°C) | ξ (wt %) | order | k_0 | E_{act} (kJ/mol) |
|---------------------------------|----------|--------------|-------|----------------------|------------------------|
| Anderson and Freeman (1961) | 246–480 | <3 | 0 | | 201 ^{a,b} |
| | | 3–15 | 0 | | 255 ^{a,b} |
| | | 15–35 | 0–1 | | |
| | | 35–95 | 1 | | 280 ^{a,b} |
| Bockhorn and Knümann (1993) | 200–600 | 0–100 | 0.81 | 7.2×10^{13} | 259 ^c |
| Jellinek (1950) | | | | | |
| $M_w = 11\ 000$ g/mol | 375–436 | <40 | 0 | $10^{13.6}$ | 192 ^c |
| $M_w = 16\ 000$ g/mol | 375–436 | <40 | 0 | $10^{15.8}$ | 220 ^c |
| $M_w = 23\ 000$ g/mol | 375–436 | <40 | 0 | $10^{19.8}$ | 276 ^c |
| Klose (1972), TGA | 385–520 | 10–70 | 1 | 1.1×10^{18} | 275 ^{d,b} |
| TGA (1–10 °C/min) | 385–520 | 10–70 | 1 | 1.2×10^9 | 159 ^{d,b} |
| Madorsky (1952) | 385–405 | <20 | 1 | 4×10^{13} | 200 ^e |
| | 385–405 | >20 | 1 | 8×10^{19} | 284 ^e |
| Mucha (1976) | | | | | |
| HDPE | 387–467 | 10–70 | 0–1 | | 330–247 ^{e,d} |
| LDPE | 387–467 | 10–70 | 0–1 | | 163–230 ^{e,d} |
| Rychly and Rychlã (1989) | 397–496 | 0–30 | | | 281 ^{b,d} |
| Sawaguchi <i>et al.</i> (1990) | | | 1 | 9.9×10^{12} | 225 ^{d,b} |
| Urzendowski and Guenther (1971) | | | | | ^g |
| HDPE | 400–485 | 15–95 | 1 | 1.3×10^{21} | 304 ^a |
| | 410–485 | 15–95 | 1 | 7.1×10^{21} | 320 ^d |
| LDPE | 375–480 | 5–95 | 1 | 3.1×10^{20} | 290 ^a |
| | 380–485 | 5–95 | 1 | 5.8×10^{21} | 303 ^d |
| Wu <i>et al.</i> (1993) | | | | | |
| HDPE | 327–487 | | 0.74 | 9.3×10^{13} | 234 ^d |
| LDPE | 327–487 | | 0.63 | 1.2×10^{12} | 206 ^d |
| this study | | | | | |
| HDPE | 400–450 | 70–90 | 1 | 1.9×10^{13} | 220 |
| LPDE1 | 400–450 | 70–90 | 1 | 1.0×10^{15} | 241 |
| LDPE2 | 400–450 | 70–90 | 1 | 9.8×10^{11} | 201 |

^a Measurements performed in a vacuum environment. ^b Possible mass and heat transfer limitations during experiment. ^c Equation 2 used. ^d Measurements performed in a nitrogen environment. ^e Activation energy decreases with increasing molecular weight of sample from 7×10^3 g/mol to 707×10^3 g/mol. ^f Activation energy decreases with increasing number of side chains. ^g Measurements performed in a steam environment.

Table 2. Kinetic Constants Reported in the Literature for the Pyrolysis Reaction of PP

| authors | T (°C) | ξ (wt %) | order | k_0 | E_{act} (kJ/mol) |
|--------------------------------|----------|--------------|-------|----------------------|---------------------|
| Bockhorn and Knümann (1993) | 200–600 | 0–100 | 0.78 | 8.6×10^{11} | 224 ^{a,b} |
| Dickens (1982), iPP | 380–435 | 50–90 | | | 258 ^c |
| | 380–435 | 26–90 | | | 230 ^c |
| Dickens (1982), aPP | 380–435 | 26–90 | | | 213 ^c |
| Gambiroza <i>et al.</i> (1992) | 100–600 | 5–90 | | | 83–128 ^d |
| | 100–600 | 9–53 | | | 99 ^d |
| | 100–600 | 10–50 | | | 99 |
| Kiang <i>et al.</i> (1980) | | | | | |
| iPP | 388–438 | | 1 | 3.3×10^{13} | 213 |
| aPP | 388–438 | | 1 | 1.4×10^{15} | 234 |
| Madorsky and Straus (1954) | 400 | | | | 243 ^e |
| Murata and Makino (1975) | 370–410 | | 1 | 4×10^{18} | 251 ^c |
| Saitoh and Nishizaki (1977) | | | | | 285 |
| Sawaguchi <i>et al.</i> (1981) | | | | | |
| aPP | | | 1 | 1.2×10^{10} | 173.9 ^b |
| iPP | | | 1 | 2.0×10^{10} | 171.8 ^b |
| Straus and Wall (1961) | | | 1 | $10^{14.4}$ | 247 ^e |
| Stuetz <i>et al.</i> (1975) | | | 1 | | 243 ^c |
| Wu <i>et al.</i> (1993) | 367–487 | | 0.90 | 6.3×10^{10} | 184 ^c |
| this study | | | | | |
| PP1 | 400–440 | 70–90 | 1 | 3.2×10^{15} | 244 |
| PP2 | 400–440 | 70–90 | 1 | 2.2×10^{11} | 188 |

^a Equation 2 used. ^b Possible mass and heat transfer limitations during experiments. ^c Measurements performed in nitrogen environment. ^d Activation energy increases with increasing conversion. ^e Measurements performed in vacuum environment. ^f Measurements performed in steam environment.

experimental results. The reported first-order kinetic constants are presented in Figure 2.

The same conclusions which were drawn for PE are also valid for PP, since similar mechanisms and therefore models apply to describe the pyrolysis kinetics of both polymers.

2.5. Kinetic Parameters for the Pyrolysis of Mixtures of PE and PP. Almost no kinetic data are available in the literature for the pyrolysis of mixtures of PE and PP. The only study ever published, to our knowledge, concerning this subject is the one by Bhargava *et al.* (1988), but in the interpretation of the results

both the reaction order and the activation energy were varied, while no preexponential factors were reported, so no quantitative conclusions can be drawn on the basis of this study.

2.6. Kinetic Parameters for the Pyrolysis of Polystyrene. The pyrolysis of PS differs from the pyrolysis of PE and PP since PS pyrolysis yields large amounts of its monomer, styrene, while the product spectra of PE and PP are more or less random, provided that secondary gas phase reactions do not occur (Seeger and Cantow (1975) and Seeger and Ritter (1977)). Because of this fact, the kinetic models used for PS differ

Table 3. Kinetic Parameters Reported in the Literature for the Pyrolysis of PS

| authors | T ($^{\circ}\text{C}$) | ξ (wt %) | order | k_0 | E_{act} (kJ/mol) |
|-------------------------------|----------------------------|--------------|-------|----------------------|---------------------------|
| Anderson and Freeman (1961) | 246–430 | 0–10 | 0 | | 193 ^{a,b} |
| | 246–430 | 15–95 | 1 | | 231–273 ^{a,b} |
| Bockhorn and Knümann (1993) | 200–600 | 0–50 | 1.1 | 8.3×10^{19} | 310 ^{c,b} |
| Cascaval (1970) | 355–810 | | 0 | | 83 ^{a,d} |
| | 355–810 | | 1 | | 90 ^{a,d} |
| Fuoss <i>et al.</i> (1964) | 394 | | 1 | 5.0×10^{24} | 323 ^d |
| Jellinek (1950) | 348–400 | | 0 | $10^{13.1}$ | 188 ^{a,d,e} |
| Kishore <i>et al.</i> (1976) | 290–390 | 50–90 | 0 | | 134 ^{c,b} |
| Kokta <i>et al.</i> (1973) | 200–500 | | 1 | | 100–140 ^g |
| | 200–500 | | 1 | | 190–230 ^g |
| Kuroki <i>et al.</i> (1982) | 310–390 | | 1 | 1.8×10^{11} | 152 ^b |
| Madorsky (1953) | 335–355 | | 1 | 9.0×10^{15} | 244 ^a |
| Malhotra <i>et al.</i> (1975) | 180–390 | | 1 | | 189–440 ^b |
| Mehmet and Roche (1976) | 200–700 | | 1 | $10^{14.5-10^{15}}$ | 219–229 ^{a,i} |
| Mertens <i>et al.</i> (1982) | 500–800 | | 1 | | 92 ^c |
| Risby <i>et al.</i> (1982) | | | | | |
| M_w 100.000 g/mol | 200–600 | | 1 | 3.6×10^{13} | 176 |
| M_w 390.000 g/mol | 200–600 | | 1 | 6.1×10^{12} | 165 |
| Sato <i>et al.</i> (1983) | 100–600 | | 0.75 | 3.5×10^{11} | 177 ^b |
| Wu <i>et al.</i> (1993) | 367–487 | | 0.5 | 5.0×10^{10} | 173 ^c |
| this study | 365–400 | 70–90 | 1 | 3.3×10^{13} | 204 |

^a Measurements performed in vacuum environment. ^b Possible mass and heat transfer limitations. ^c Measurements performed in nitrogen environment. ^d Activation energy decreases with increasing heating rate, conversion, and molecular weight. ^e Preexponential constants decreases slightly with increasing molecular weight. ^f No influence of heating rate reported. ^g Activation energy increases with molecular weight for molar weights below 3.6×10^5 g/mol. ^h Activation energy increases with molecular weight for molecular weights below 10^5 g/mol and is a function of conversion, heating rate, number of side chains, degree of cross-linking. ⁱ Preexponential constant increases with molecular weight, but activation energy does not change. Effect is reported to be due to an increase of viscosity.

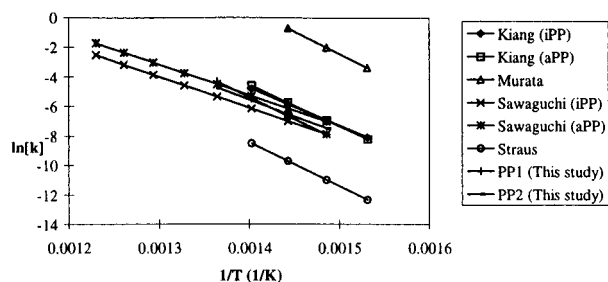
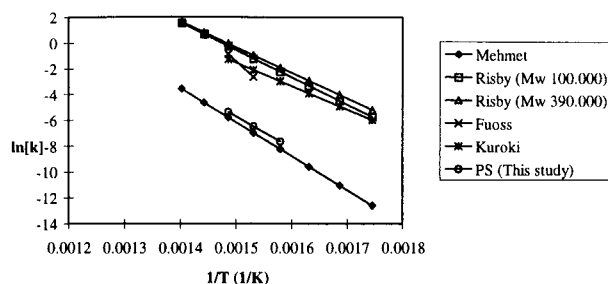
**Figure 2.** Arrhenius plot for the reported first-order kinetic constants in literature for PP.**Figure 3.** Arrhenius plot for first-order kinetic constants for the pyrolysis of PS reported in literature.

from those used for PE and PP. Nevertheless, a number of authors reported kinetic parameters derived by using eq 1 or 2. Their kinetic parameters are presented in Table 3, whereas the corresponding first order constants are plotted in Figure 3.

In most studies it was recognized that the complex pyrolysis kinetics of PS cannot be described by the simple power law model, and consequently more complex kinetic models were employed. Examples of authors, who published or used such models, are Bouster *et al.* (1980), Cameron *et al.* (1967), Carniti *et al.* (1991), Darivakis *et al.* (1990), Ebert *et al.* (1982), Jellinek (1948), Kuroki *et al.* (1982), Schröder *et al.* (1984), and Shlensky *et al.* (1988). All these models are based on more or less the same reaction mechanism, but assume different rate-controlling steps.

The conclusion of our literature study is that for none

of the polymers studied reliable kinetic parameters applicable over a wide conversion range and reaction conditions are available. In our opinion, the use of simple first-order kinetic models, which are not appropriate to describe the pyrolysis kinetics over a large conversion range, is the main cause of this fact. Despite the fact that more complex models were available in the literature, they did not find frequent application because of the large number of fit parameters, which makes their practical use very difficult.

3. Kinetic Models

3.1. Introduction. During the course of this study several models were evaluated to describe the pyrolysis kinetics of PE, PP, and PS. The following criteria were formulated to judge the applicability of these models:

- number of fit parameters should be two or less,
- implementation of the kinetic model in single particle heat transfer and reactor models should be possible,
- the model should possess a clear physical background, and

(iv) prediction of influence of key parameters (molecular weight, branching, temperature) should be possible. In this study the results obtained for two of these models will be presented and discussed in more detail.

3.2. First-Order Model. The first model used to interpret the experimental data is a simple first-order power law model (see eq 2). This model was selected to enable comparison of our experimental results with literature data. However, as already stated in section 2.2, this model is only applicable in a small conversion range, because the actual reaction order varies with the conversion. In the present study the use of the first order power law model was restricted to the 70–90% conversion range, since most studies have revealed that this description is valid in this conversion range.

3.3. Random Chain Dissociation Model. The second model was developed during this study to describe the pyrolysis kinetics on a more fundamental basis. This model incorporates a statistical reaction pathway model, which has successfully been applied to

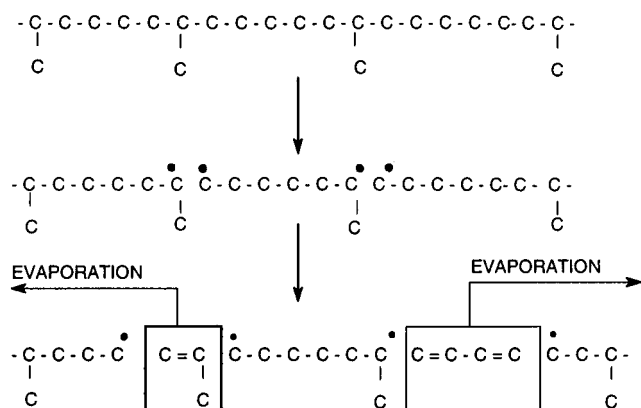

Figure 4. Schematic representation of processes incorporated in the RCD model.

describe the pyrolysis kinetics of wood (Wagenaar (1994) and McDermott and Klein (1988)). The model accounts for the fact that both physical and chemical processes play an important role during the pyrolysis of polymers. When apparatus such as a screen heater or TGA are used for a kinetic study of a pyrolysis process, in fact the rate of evaporation of pyrolysis products is measured, but not the intrinsic chemical reaction (the breaking of bonds) rate. Not every broken bond in the polymer chain leads to the evaporation of product: only polymer chain fragments small enough to evaporate at the given reaction temperature will actually leave the polymer sample. This implies that both physical and chemical processes influence the measured rate of change of the polymer mass and hence the observed pyrolysis kinetics.

To account for the physical and chemical processes in our model, termed the random chain dissociation (RCD) model, a polymer chain is represented as a chain of carbon atoms with side chains (see Figure 4). With each bond type i between the carbon atoms a certain rate constant k_i can be associated. The number of bonds of type i is represented by N_i and the rate of change of the number of each bond type is described by a simple first-order model:

$$\frac{\partial N_i}{\partial t} = -k_{0i} e^{(-E_{act,i}/RT)} N_i = -k_i N_i \quad (3)$$

Different types of bonds possess different breakage rates and associated rate constants, such as β -bonds and bonds between carbon atoms to which a side chain is attached have higher breakage rates, due to the formation of relatively stable radicals during the reaction. This is accounted for in the model by distinguishing between different types of bonds and the specification of different kinetic parameters (*i.e.*, k_{i0} and $E_{act,i}$) for each type of bond. The conversion is calculated by determining the number and weight of the fragments in the polymer chain with a length (including side chains) less than a certain length L_c , which just can evaporate. This parameter L_c is a function of the temperature and pressure, and its value can be estimated from the boiling points of normal alkanes and alkenes. Other input parameters required by the model are the length and the extent of branching of the main chain. These parameters can be determined from the initial molecular weight and the structure of the polymer. The branches on the main chain can either be methyl, ethyl, propyl, or even benzyl groups. These groups are assumed to be distributed evenly over the main chain.

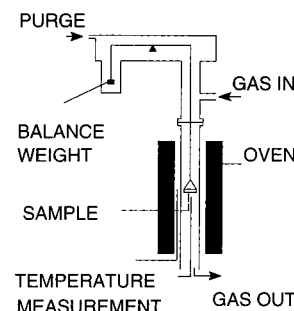

Figure 5. Schematic representation of experimental equipment.

Some simplifications were made in our present version of the RCD model to limit the required number of fit parameters. The number of fit parameters would increase significantly if a more detailed reaction scheme would be implemented (intramolecular, intermolecular, or cyclization reactions), which would make the application of the model more difficult. Another important simplification of the model in its present state is the fact that only the carbon atoms are accounted for in the model. No information is stored about the hydrogen atoms present in the polymer.

As stated before, the most important difference between the first-order model and the RCD model is that the latter model accounts for the influence of physical processes (not every broken bond leads to the evaporation of a fragment of the polymer chain). However, at high conversions the polymer chain is degraded to relatively small fragments, which will immediately evaporate if another bond in the fragment is broken. Therefore every broken bond leads to the evaporation of a chain fragment at high conversions and, because of the direct coupling of the breakage rate and the evaporation rate at high conversions, the evaporation rate exhibits first order behavior as does the breakage rate.

The RCD model combines the most relevant features of the different models proposed in the literature without introducing a large number of fit parameters: the difference between evaporation rate and breakage rate is accounted for (as in the Simha and Wall model or in a simpler form in the consecutive reaction models), and the model also accounts for the presence of weaker bonds in the polymer chain (weak bond model) by accounting for side chains and different types of bonds.

With the RCD model the conversion *versus* time curve can be calculated and from this information the conversion rate *versus* time or conversion can be determined. The RCD model can also be used to predict the product spectrum of the primary pyrolysis reaction. Because of the statistical nature of the model, several runs have to be performed and averaged to obtain an average conversion *versus* time curve.

4. Experimental Equipment and Procedures.

To provide experimental data for development of improved kinetic models for pyrolysis of the aforementioned polymers, the conversion rate of these polymers was determined as a function of temperature over a wide conversion range. A Seteram TG-85 TGA (see Figure 5) was used for all experiments reported in this paper.

Prior to an experiment, a polymer sample with a mass of less than 3 mg was inserted into a small quartz-glass crucible (diameter was 10 mm). Subsequently, the crucible was positioned in the TGA and connected to a weighing device with a thin wire, which registered the weight of the crucible during the pyrolysis experiment. At the beginning of each experiment a preheated oven

(Meyvis) with a quartz tube was moved into position around the crucible, while a nitrogen flow fed through the TGA was used to establish the desired inert atmosphere. The temperature of both the crucible and the gas phase flowing through the TGA were measured with a K-type thermocouple before and after each experiment. The weight of the crucible containing the sample was recorded during the experiment using a computer equipped with an A/D-converter. On the basis of the polymer mass *versus* time curve, the conversion and the conversion rate were calculated as a function of time.

All experiments were performed under isothermal conditions with the exception of a short heating period. The isothermal operation mode was preferred because the correct evaluation of nonisothermal experiments is extremely difficult.

Prior to performing the actual pyrolysis experiments, the external mass and heat transfer characteristics to the crucible were studied. The external mass transfer coefficient was determined from naphthalene evaporation experiments (Wigmans *et al.* (1983)), whereas the external heat transfer coefficient was determined by measuring the temperature *versus* time curve of the crucible during the heating period with a small K-type thermocouple inserted into the crucible. From this data the external heat transfer coefficient to the crucible could be calculated. The measured external heat transfer coefficient did not depend on the gas flow rate through the quartz tube and was $45 \pm 6 \text{ W/m}^2 \text{ K}$ based on the external surface of the entire crucible. The external mass transfer coefficient obtained from the naphthalene evaporation experiments was $3 \times 10^{-3} \pm 2 \times 10^{-4} \text{ m/s}$ based on the open top surface of the crucible. Each pyrolysis experiment was checked for internal and external heat transfer limitations, which can cause a significant difference between the actual sample temperature and the gas phase temperature. Experiments for which the calculated temperature difference was larger than 2°C were not considered for further analysis. Because of this requirement, it was not possible to determine kinetic constants at temperatures exceeding 450°C for the pyrolysis of PE and PP and 400°C for PS.

5. Experimental Results

5.1. Introduction. In this study two low density polyethene's (LDPE1 and LDPE2) with an average initial molecular weight of 350 000 g/mol, but different initial molecular weight distributions were used. A high density polyethene (HDPE) with an average initial molecular weight of 125 000 g/mol and two isotactical polypropene's (PP) with average initial molecular weights of respectively 250 000 g/mol (PP1) and 427 000 g/mol (PP2) were also investigated, together with a PS with an average initial molecular weight of 280 000 g/mol.

Pyrolysis experiments were performed in the temperature range between 400 and 450°C for PE and PP and in the temperature range between 365 and 400°C for PS. At each temperature two or more pyrolysis experiments were performed. An example of a measured conversion rate *versus* conversion curve is shown in Figure 6, which includes the fitted curves for the first-order model and the RCD model. From this figure it can be seen that the RCD model can accurately represent the experimentally determined conversion rate *versus* conversion curve over the entire conversion range.

5.2. Kinetic Data Obtained for the First-Order Model. An example of an Arrhenius plot for HDPE is

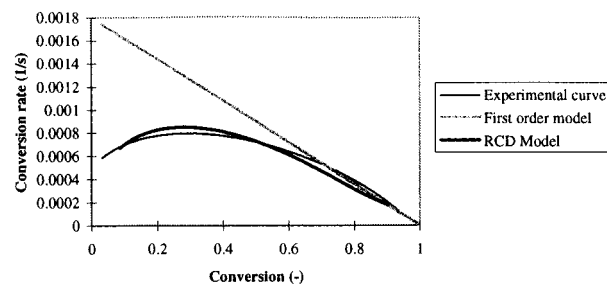

Figure 6. Measured and calculated conversion rates *versus* conversion for a typical HDPE pyrolysis experiment conducted at 440°C .

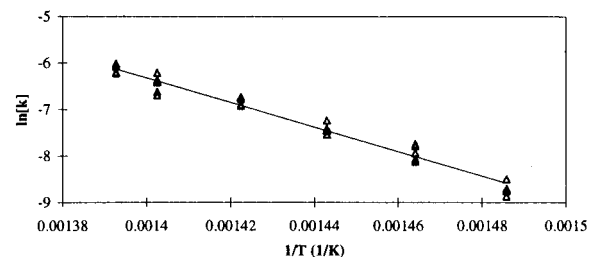

Figure 7. Arrhenius plot for measured first-order kinetic constants (70–90% conversion) for HDPE.

Table 4. Fitted First-Order Kinetic Parameters (70–90% conversion) for Different Polymers

| polymer | $k_0 \text{ (s}^{-1}\text{)}$ | $E_{\text{act}} \text{ (kJ/mol)}$ | $k_{703 \text{ K}} \text{ (10}^{-3} \text{ s}^{-1}\text{)}$ | r^2 |
|---------|-------------------------------|-----------------------------------|---|-------|
| HDPE | 1.9×10^{13} | 220 | 0.9 | 0.97 |
| LDPE1 | 1.0×10^{15} | 241 | 1.2 | 0.96 |
| LDPE2 | 9.8×10^{11} | 201 | 1.1 | 0.95 |
| PP1 | 3.2×10^{15} | 244 | 2.4 | 0.94 |
| PP2 | 2.2×10^{11} | 188 | 2.4 | 0.94 |
| PS | 3.3×10^{13} | 204 | 22.9 | 0.96 |

^a Only gives indication of experimental uncertainty.

Table 5. Fitted Kinetic Parameters for RCD Model for the Pyrolysis of Different Polymers

| polymer | $k_0 \text{ (s}^{-1}\text{)}$ | $E_{\text{act}} \text{ (kJ/mol)}$ | $k_{703 \text{ K}} \text{ (10}^{-4} \text{ s}^{-1}\text{)}$ | r^2 |
|---------|-------------------------------|-----------------------------------|---|-------|
| HDPE | 1.3×10^{11} | 207 | 0.5 | 0.99 |
| LDPE1 | 9.2×10^{13} | 244 | 0.7 | 0.94 |
| LDPE2 | 3.5×10^{12} | 225 | 0.7 | 0.96 |
| PP1 | 8.4×10^{13} | 237 | 2.1 | 0.96 |
| PP2 | 3.7×10^{10} | 192 | 2.0 | 0.95 |
| PS | 1.3×10^{14} | 219 | 69.4 | 0.97 |

^a Only gives indication of experimental uncertainty.

shown in Figure 7. The fitted preexponential constants and activation energies are summarized in Table 4 for all polymers studied. On the basis of the experimental results and the first-order model, three remarks should be made. Because of the small temperature range in which TGA experiments can be performed (only 50°C), the mutual dependence of the calculated value of the preexponential constant and the activation energy is large. While the kinetic constants for PP1 and PP2 do not differ significantly at a given temperature (see Table 4), the calculated activation energies and preexponential constants differ by respectively 56 kJ/mol and 4 orders of magnitude. Due to the strong mutual influence of the calculated values of k_0 and E_{act} , it can only be concluded that (i) activation energies are in the order of 200 kJ/mol and (ii) preexponential factors are in the order of 10^{13} s^{-1} , which is a quite common value encountered in studies on thermal decomposition reactions of organic compounds (Darivakis *et al.* (1990)).

The second observation concerns the influence of the extent of branching of the main polymer chain on the

conversion rate at a given temperature. Our results indicate (see Table 4) that branching has a clear influence on the reaction rate. If the kinetic constants of different polymers are evaluated at a given temperature, the reaction rate increases in the following order: HDPE < LDPE < PP < PS, which implies that the conversion rate increases with the extent of branching, as HDPE chains are not branched at all and LDPE chains have some branches (about 50 methyl groups/1000 carbon atoms), while PP and PS chains are highly branched (500 methyl or benzyl group/1000 carbon atoms). The reaction rate also increases with increasing stability of the radicals formed during the pyrolysis process ($\text{CH}_3 < 1^\circ < 2^\circ < 3^\circ < \text{benzyl}$, Morrison and Boyd (1992)). The rate at which radicals are formed increases with their stability, and therefore, the conversion rate is higher if the radicals, which are formed during the pyrolysis process, are more stable. A high degree of branching therefore leads to a high conversion rate, because the formation of relatively stable 3° and 2° radicals is possible for chains which are branched, but not for linear chains, which produce less stable 2° and 1° radicals. Another effect of branching is a possible change of the reaction mechanism with increasing conversion. The bonds next to a side chain exhibit a higher breakage rate than do normal bonds. These bonds will therefore mainly break during the initial phase of the reaction and therefore lead to a more flat maximum in the conversion *versus* conversion rate curve or to a shift of this the maximum (weak-link model, Oakes and Richards (1949)). This is the reason for the somewhat different pyrolysis behavior of LDPE compared to HDPE (less pronounced maximum).

The third conclusion, which can be drawn on the basis of our experiments, is that the influence of the initial molecular weight or initial molecular weight distribution is negligible. At a given temperature, the different PP types (PP1 and PP2) with initial molecular weights of respectively 250 000 and 427 000 g/mol degraded at virtually the same rate. The difference between the conversion rates of LDPE1 and LDPE2 with different initial molecular weight distributions is also negligible. This implies that the effect of the initial molecular weight on the conversion rate of polymers is minor. This conclusion can also be drawn on the basis of a closer examination of the literature data. While activation energies and preexponential constants appear to vary with the initial molecular weight (Mucha (1976), Malhotra *et al.* (1975), and Kokta *et al.* (1973)) at a given temperature, the actual reaction rate constants do not vary significantly with the initial molecular weight (Jellinek (1950) and Risby *et al.* (1982)). The negligible influence of the initial molar weight was also predicted by our RCD model. The effect of structural parameters (atacticity or isotacticity) is also negligible (Sawaguchi *et al.* (1981) and Kiang *et al.* (1980)), which implies that kinetic parameters measured for one type of polymer should be comparable to those of polymers of the same type with a different structure or molecular weight. However, for the interpretation of the experimental data a proper model should be used and the polymers should be free of impurities, especially additives, added to prevent long term degradation of the polymer at low temperatures, as they can significantly influence the pyrolysis rate.

5.3. Kinetic Data Obtained from the RCD Model. The experimental results were also fitted using the RCD model over the entire conversion range (10–90% conversion), instead of the 70–90% conversion range as is required for the first-order model to obtain a good fit.

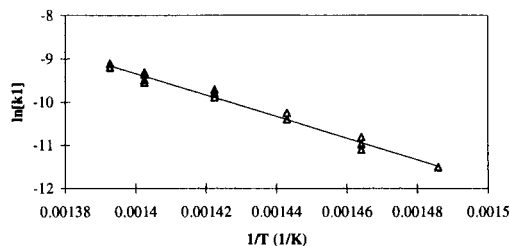

Figure 8. Arrhenius plot of the measured kinetic constants (10–90% conversion) for HDPE pyrolysis obtained with RCD model.

The initial and final part of the conversion *versus* time curve were omitted to eliminate any possible effect of the initial heating period and experimental errors.

The main problem encountered when the RCD model was fitted to the experimental data was the maximum in the conversion rate *versus* conversion curve predicted by the RCD model, a phenomenon which could not always be observed clearly in the experiments. All experimental curves, which did not possess a maximum, showed a constant reaction rate at low conversions. The maximum was not observed in this case, possibly due to branching of the polymer chain or due to the occurrence of the maximum in the part of the curve, which was eliminated.

In Figure 8, the Arrhenius plot of the fitted kinetic constants using the RCD model is shown for HDPE, while the corresponding kinetic parameter for this and other polymers are summarized in Table 5.

All experimental data reported in this paper were fitted assuming a negligible influence of β -scission in the RCD model. For LDPE it was assumed that the effect of branching was negligible (fitted as HDPE). Both assumptions were made to reduce the number of fit parameters required from six to two. Simulations with the RCD model, which will be presented in detail in section 6, showed that these simplifications did not influence the results significantly.

5.4. Pyrolysis Kinetics of Mixtures of Polymers.

In practice, mixtures of polymers will be present in household waste. It is therefore important to know whether the pyrolysis kinetics of a polymer is influenced by the presence of a second polymer, which would be the case if intermolecular reactions would play a dominant role during the pyrolysis process. To examine whether this effect exists, mixtures of LDPE1 and PP2 were prepared in an extruder and subsequently pyrolyzed. Three mixtures (25, 50, and 75 wt % PE) were examined at a temperature of 425 °C. In the pyrolysis experiments with pure and mixed polymers, no significant difference in pyrolysis kinetics could be observed, which might be due to the fact that the kinetic constants for PE and PP pyrolysis only differ by a factor of 2 in the temperature range from 400 to 450 °C. It can be concluded however that there is no large mixing effect on the conversion rate. It is therefore possible to apply a linear mixing rule for the kinetic constants to calculate the kinetic constant of the mixture.

6. Simulations with RCD Model. In our study we have simulated the effect of the following factors on the pyrolysis kinetics of polymers:

- (i) initial molecular weight,
- (ii) extent of branching, and
- (iii) type of reaction mechanism assumed.

To examine the different effects, a standard simulation case was defined for which the parameter values are given in Table 6. In the simulations with the RCD model for the normal bonds, the kinetic constants of HDPE were used as the main polymer chain of HPDE

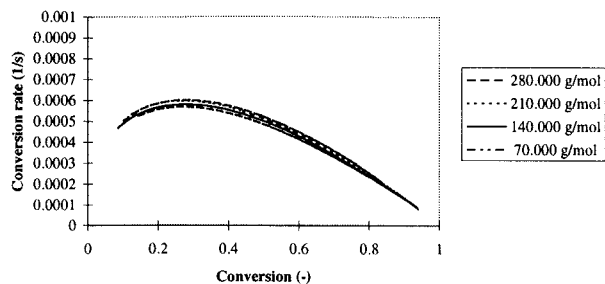

Figure 9. Effect of initial molecular weight on calculated conversion rate.

Table 6. Input Parameters Standard Simulation Case

| parameter | value |
|--------------------------|-------------------------------------|
| N_c | 20 000 |
| polymer type (branching) | HDPE (no branching) |
| L_c | 28 |
| k_{10} | $1.3 \times 10^{11} \text{ s}^{-1}$ |
| $E_{\text{act},1}$ | 207 kJ/mol |
| k_{20} | |
| $E_{\text{act},2}$ | |
| k_{30} | $8.4 \times 10^{13} \text{ s}^{-1}$ |
| $E_{\text{act},3}$ | 237 kJ/mol |
| T | 430 °C |

is not branched. This implies that all bonds in the main chain are representative of normal bonds. All bonds in the main chain of PP are next to a carbon atom with a side chain, which means that these bonds are representative of bonds next to a side chain. For this reason the RCD model kinetic constants for PP were used for bonds next to side chains.

Simulations at different temperatures showed that, as expected, the temperature significantly influences the conversion rate, because, on the one hand, the kinetic constants for bond cleavages strongly increases, while, on the other hand, the minimum length of the chains which can evaporate under the prevailing conditions increases. Both effects cause an increase in the conversion rate with increasing temperature.

The predicted influence of the initial molecular weight on the conversion rate is negligible, as can be seen from Figure 9. This was also observed experimentally (see section 5). The fact that the influence of the initial molecular weight is minor is not surprising. The initial molecular weight of a polymer can in principle decrease by a factor of 2 by cleavage of just 1 bond exactly in the middle of the polymer chain. As the total number of bonds broken is much larger, it is to be expected that a single broken bond does not influence the conversion rate significantly. The initial molecular weight will drop sharply at the beginning of the reaction (each broken bond reduces the average molecular weight), but will not change much after the initial stage of the reaction as any decrease in molecular weight of the polymer fragments leads to the evaporation of small fragments, which therefore will not count when evaluating the average molecular weight of the sample.

The predicted effect of branching on the conversion rate is shown in Figure 10. The influence of a small number of branches on the main polymer chain (LDPE) is minimal, but the effect on the conversion rate of a high number of branches is very significant. The bonds next to the side chains have a higher breakage rate and this causes an increasing conversion rate with an increasing number of branches. A second effect is that more bonds have to be broken in the main chain because of the presence of the side chains. Because the maximum number of carbon atoms in the fragments that can evaporate remains the same, the number of carbon

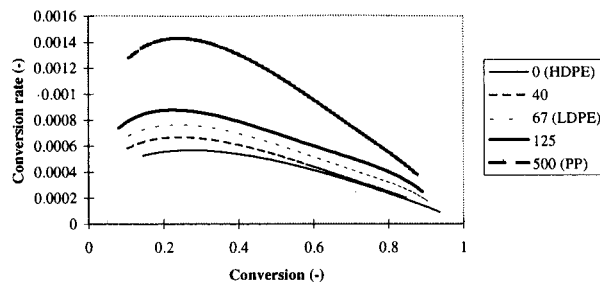

Figure 10. Calculated conversion rate versus conversion for different numbers of methyl groups per 1000 carbon atoms in main polymer chain.

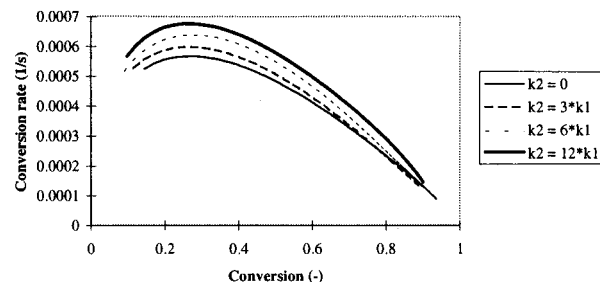

Figure 11. Effect of kinetic constant for β -scission (k_2) on calculated conversion rate.

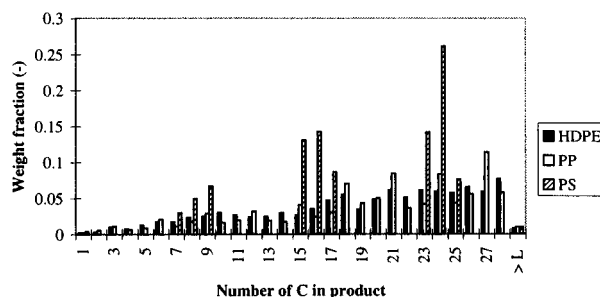

Figure 12. Calculated product spectrum for the pyrolysis of different polymers.

atoms in the main chain of the fragment has to be smaller if branching is present, because the side chains also contribute when evaluating the number of carbon atoms in the fragment. This implies that more bonds have to be broken in the main polymer chain, which limits the conversion rate somewhat. This effect, however, is minor compared to the increased cleavage rate of the bonds caused by the presence of the side chains.

In the base case β -scission was neglected. This was allowed, because the effect of β -scission on the conversion rate is minimal (see Figure 11). Even if the kinetic constant for β -scission is higher than the kinetic constant for normal bond cleavage, the increase in the breakage rate is minimal, because the number of β -bonds is low compared to the number of normal bonds, which causes a low additional conversion rate due to β -scission (see eq 3). The impact of β -scission on the conversion rate is also small because the molecular weight of the product formed, usually ethene, is low, compared to the average weight of the products formed by the breakage of normal bonds. The major influence of β -scission is not on the conversion rate, but on the product spectrum obtained. With increasing occurrence of β -scission, the fraction of C_2 products formed increases significantly. In a related study in which kinetic experiments were performed with a screen heater (Westerhout *et al.* (1996)), the gaseous products of the primary pyrolysis reaction were also determined. In these experiments negligible amounts of ethene and other C_2 products were found. It can therefore be

concluded that the β -scission of bonds can be neglected in the temperature range mentioned.

One of the important features of the novel RCD model is its possibility to predict the product spectrum of the primary pyrolysis. As an example, the computed product spectra for PE, PP, and PS pyrolysis are shown in Figure 12. The product spectrum of PE is more or less random. Although the weight fractions of the pyrolysis products increase with increasing carbon number, the mole fractions of these products produced are the same for all products. The product spectra for PP and PS are not random because the side chains influence the product distributions.

7. Conclusions

A literature study on the pyrolysis kinetics of PE, PP, and PS showed that in most studies a standard power law kinetic model was assumed to describe the pyrolysis rate. This approach accounts to a large extent for the significant scatter in literature data (*i.e.*, kinetic parameters such as k_0 and E_{act}) and many authors have recognized that more complex kinetic models are required to accurately describe the pyrolysis process over a wide conversion range.

Complex kinetic models proposed for PE and PP pyrolysis based on an infinite number of parallel reactions, weak links, consecutive reactions, or complex mechanisms published so far have limited practical use, because they do not describe the pyrolysis reaction adequately over a large conversion range or require a large number of fit parameters, which are difficult to determine experimentally. To describe the pyrolysis kinetics of PS many different models, were proposed because the use of a simple power law model over a large conversion or temperature range is not possible in this case.

To provide kinetic parameters and models for the design of pyrolysis reactors, the pyrolysis kinetics of the forementioned polymers was studied at temperatures below 450 °C using a TGA. The experimental data was interpreted using the random chain dissociation model (RCD), which was developed during this study. Also a simple first-order model was used to describe the pyrolysis kinetics at high conversions (70–90 %) to enable comparison of our data with literature data. The RCD model accounts for the fact that not every broken bond leads to the evaporation of a fragment: only fragments small enough to evaporate will actually evaporate from the sample. This is particularly important as in most kinetic experiments the evaporation rate of the products is measured. Important other advantages of the RCD model compared to existing models proposed in literature are the low number of fit parameters and its ability to predict primary pyrolysis product spectra. The main disadvantage of the RCD model is given by the fact that it is not possible to derive an analytical representation of the pyrolysis kinetics

Using both the first order model and the RCD model, the pyrolysis kinetics of PE, PP, and PS were fitted from the experimental data. Both models fit the experimental data well, but the RCD model can be used over a much wider conversion range.

It was found experimentally that the pyrolysis kinetics of pure polymers was not influenced significantly if they were mixed thoroughly and subsequently pyrolyzed.

It was shown (both theoretically with the RCD model and experimentally) that the pyrolysis kinetics of forementioned polymers was not affected significantly by

the initial molecular weight. It was found experimentally that the pyrolysis rate increases with an increasing number of branches. The conversion rate for the different polymers increases in the order HDPE < LDPE < PP < PS, which can be explained in terms of the stability of the free radicals produced during the pyrolysis process. This effect of the extent of branching is also predicted by the RCD model. The effect of β -scission on the conversion rate was found to be insignificant at the low temperatures studied.

Due to the minor influence of the structure and the initial molecular weight on the pyrolysis rate of a certain polymer type, the kinetic constants determined in this study can also be used for other polymers of the same type provided that the polymer does not contain impurities.

Acknowledgment

The authors would like to acknowledge Sandor Zuuren-donk and Koen Wolf for their help with the experiments and Robert Meijer for his technical assistance.

Symbols

E_{act} = activation energy [J/mol]
 k = reaction constant [s^{-1}]
 k_0 = preexponential reaction constant [s^{-1}]
 m = mass of sample [kg]
 M_w = average initial molar weight [kg/mol]
 L_c = number of carbon atoms of largest molecule which can evaporate [-]
 n = reaction order
 N = number of bonds
 R_g = universal gas constant, 8.314 [J/mol K]
 t = time [s]
 T = temperature [K]

Greeks

ξ = conversion, $(m_0 - m)/m_0$

Subscripts

c = carbon atoms in total chain
 i = reaction i
 0 = initial
 1 = normal bond
 2 = β -bond
 3 = bond next to side chain

Literature Cited

- Anderson, D. A.; Freeman, E. S. The Kinetics of the Thermal Degradation of PolyStyrene and PolyEthylene. *J. Polym. Sci.* **1961**, *54*, 253–260.
- Batelle Memorial Institute. Monomeric Recovery from Polymeric Materials. U.S. Patent 5, 136, 117, 1992.
- Bharwaj, I. S.; Kumar, V.; Palanivelu, K. Thermal Characterisation of LDPE and LLDPE Blends. *Thermochim. Acta* **1988**, *131*, 241–246.
- Bockhorn, H.; Knümann, R. Pyrolyse von PVC und Kunststoffgemischen bei Milden Bedingungen als Möglichkeit zur Auftrennung von Kunststoffabfällen. *VDI Ber.* **1993**, *1090*, 423–430.
- Bouster, C.; Vermande, P.; Veron, J. Study of the Pyrolysis of Polystyrenes 1. Kinetics of Thermal Decomposition. *J. Anal. Appl. Pyrolysis* **1980**, *1*, 297–313.
- Cameron, G. G. Mechanism of Volatile Production during Pyrolysis of PolyStyrene. *Macromol. Chem.* **1967**, *100*, 255–261.
- Carniti, P.; Beltrame, P. L.; Massimo, A.; Gervasini, A.; Audisio, G. PolyStyrene Thermodegradation. 2. Kinetics of Formation of Volatile Products. *Ind. Eng. Chem. Res.* **1991**, *30*, 1624–1629.
- Cascaval, C. N. Über die Kinetik des Thermischen Abbaues von Polystyrolen. *Macromol. Chem.* **1970**, *131*, 55–62.
- Conesa, J. A.; Marcilla, A.; Font, R. Kinetic Model of the Pyrolysis of PolyEthylene in a Fluidised Bed Reactor. *J. Anal. Appl. Pyrolysis* **1994**, *30*, 101–120.

- Darivakis, G. S.; Howard, J. B.; Peters, W. A. Release Rates of Condensables and Total Volatiles from Rapid Devolatilization of Polyethylene and Polystyrene. *Combust. Sci. Tech.* **1990**, *74*, 267–281.
- Davis, T. E.; Tobias, R. L.; Peterli, E. B. Thermal Degradation of Polypropylene. *J. Polym. Sci.* **1962**, *56*, 485–499.
- Dickens, B. Thermal Degradation Study of Isotactic Polypropylene Using Factor-Jump Thermogravimetry. *J. Polym. Sci., Polym. Chem. Ed.* **1982**, *20*, 1169–1183.
- Ebert, K. H.; Ederer, H. A.; Schröder, U. K. O. On the Kinetics and Mechanism of Thermal Degradation of Polystyrene. *Makromol. Chem.* **1982**, *183*, 1207–1218.
- Gambiroza-Jukic, M.; Cunko, R. Kinetics of the Thermal Degradation of Polypropylene Fibres. *Acta Polym.* **1992**, *43*, 258–260.
- Fuoss, R. M.; Salyer, I. O.; Wilson, H. S. Evaluation of Rate Constants from Thermogravimetric Data. *J. Polym. Sci., Part A* **1964**, *2*, 3147–3111.
- Jellinek, H. H. G. Thermal Degradation of PolyStyrene. Part I. *J. Polym. Sci.* **1948**, *3* (6), 850–865.
- Jellinek, H. H. G. Thermal Degradation of PolyStyrene and PolyEthylene. Part III. *J. Polym. Sci.* **1950**, *4*, 378–379.
- Kiang, J. K. Y.; Uden, P. C.; Chien, J. C. W. Polymer Reactions - Part VII: Thermal Pyrolysis of PolyPropylene. *Polym. Degrad. Stab.* **1980**, *2*, 113.
- Kishore, K.; Verneker, V. R.; Nair, M. N. R. Thermal Degradation of Polystyrene. *J. Appl. Polym. Sci.* **1976**, *20*, 2355–2365.
- Klose, W. Zur Pyrolyse- und Verbrennungskinetik Organischer Natur- und Kunststoffpartikeln; Technischen Universität Berlin: Berlin, 1972.
- Kokta, B. V.; Valade, J. L.; Martin, W. N. Dynamic Thermogravimetric Analysis of Polystyrene Effect of Molecular Weight on Thermal Decomposition. *J. Appl. Polym. Sci.* **1973**, *17*, 1–19.
- Koo, J.-K.; Kom S-W. Reaction Kinetic Model for Optimal Pyrolysis of Plastic Waste Mixtures. *Waste Manage. Res.* **1993**, *11*, 515–529.
- Kuroki, T.; Ikemura, T.; Ogawa, T.; Sekiguchi, Y. Kinetic Study on the First Stage during Thermal Degradation of Polystyrene. *Polymer* **1982**, *23*, 1091–1094.
- Madorsky, S. L. Rates of Thermal Degradation of PolyStyrene and PolyEthylene in a Vacuum. *J. Polym. Sci.* **1952**, *9* (2), 133–156.
- Madorsky, S. L. Rates and Activation Energies of Thermal Degradation of Styrene and Acrylate Polymers in a Vacuum. *J. Polym. Sci.* **1953**, *11* (5), 491–506.
- Madosky, S. L.; Straus, S. *J. Res. Nat. Bur. Stand.* **1954**, *53*, 361.
- Malhotra, S. L.; Hesse, J.; Blanchard, L.-P. Thermal Decomposition of Polystyrene. *Polymer* **1975**, *16*, 81–93.
- McDermott, J. B.; Klein, M. T. Chemical and Probabilistic Modeling of Complex Reactions: a Lignin Depolymerization Example. *Chem. Eng. Sci.* **1988**, *41*, 207.
- Mehmet, Y.; Roche, R. S. A Study of the Thermal Degradation of Polystyrene by Thermal Velocity Analysis. *J. Appl. Polym. Sci.* **1976**, *20*, 1955–1965.
- Mertens, J. J. R.; Jacobs, E.; Callaerts, A.; Buekens, A. Kinetic Study of the Thermal Decomposition of Polystyrene by Means of Pyrolysis Gas Chromatography. *Makromol. Chem., Rapid Commun.* **1982**, *3*, 349–356.
- Montroll, E. W.; Simha, R. *J. Chem. Phys.* **1940**, *8*, 721.
- Morrison, R. T.; Boyd, R. N. *Organic Chemistry*; Prentice Hall International: New York.
- Mucha, M. Thermogravimetric Studies on Polymethylenes and Polyethylenes. *J. Polym. Sci.* **1976**, *Symp. No. 7*, 25–31.
- Murata, K.; Makino, T. *Nippon Kagaku Kaishi* **1975**, *2*, 192. *Mitsui Zosen Gihō* **1975**, *90*, 62.
- Oakes, W. G.; Richards, W. G. The Thermal Degradation of Ethylene Polymers. *J. Chem. Soc.* **1949**, *4*, 2929–2935.
- Rijpkema, L. P. M.; Krajenbrink, G. W.; Stijnman, P. W. A.; Groot, J. L. B. Survey of Municipal Solid Waste in Europe; TNO Institute for Environmental and Energy Technology: The Netherlands, 1992.
- Risby, T. H.; Yergey, J. A.; Scocca, J. J. Linear Programmed Thermal Degradation Mass Spectrometry of Polystyrene and Poly(Vinyl chloride). *Anal. Chem.* **1982**, *54*, 2228–2233.
- Rychly, J.; Rychlá, L. Non-Isothermal Thermogravimetry of Polymer. I. General Model involving Formal Termination of Active Centres. *J. Therm. Anal.* **1989**, *35*, 77–90.
- Saitoh, K.; Nishizaki, H. *Hokkaido Kogyo Kaihatsu Shikensho Hokoku* **1977**, *30*, 15.
- Sato, A.; Kaneko, K. Differential Thermal and Chromatographic Analysis on Pyrolysis of Plastics. *J. Energy Heat Mass Transfer* **1983**, *5* (4), 323–338.
- Sawaguchi, T.; Inami, T.; Kuroki, T.; Ikemura, T. Studies on Thermal Degradation of Synthetic Polymers. XII. Kinetic Approach to Intensity Function Concerning Pyrolysis Condition for Polyethylene Low Polymer. *Ind. Eng. Chem. Process Des. Dev.* **1990**, *19*, 174–179.
- Sawaguchi, T.; Suzuki, K.; Kuroki, T.; Ikemura, T. Studies on Thermal Degradation of Synthetic Polymers. XV. Estimation of Product Yield on the Basis of Intensity Function for Thermal Gasification of Isotactic and Atactic Polypropylene. *J. Appl. Polym. Sci.* **1981**, *26*, 1267–1274.
- Schröder, U. K. O.; Ebert, K. H.; Hamielec, A. W. On the Kinetics and Mechanism of Thermal Degradation of Polystyrene. 2. Formation of Volatile Compounds. *Makromol. Chem.* **1984**, *185*, 991–1001.
- Seeger, M.; Cantow, H.-J. Thermische Spaltungsmechanismen in Homo- und Copolymeren aus α -Olefinen. *Die Makromol. Chem.* **1975**, *176*, 1411–1425.
- Seeger, M.; Ritter, R. J. Thermal Decomposition and Volatilisation of Poly(α -olefins). *J. Polym. Sci.* **1977**, *15*, 1393–1402.
- Simha, R.; Wall, L. A. Some Aspects of Depolymerisation Kinetics. *J. Polym. Sci.* **1951**, *6*, 39.
- Simha, R.; Wall, L. A. Kinetics of chain depolymerization. *J. Phys. Chem.* **1952**, *56*, 707–715.
- Simha, R.; Wall, L. A.; Blatz, P. J. Depolymerisation as a Chain Reaction. *J. Polym. Sci.* **1950**, *5*, 615–632.
- Sinn, H. Recycling der Kunststoffe. *Chem.-Ing.-Techn.* **1974**, *46* (14), 579–589.
- Sinn, H.; Kaminsky, W.; Janning, J. Verarbeitung von Kunststoffmüll und Altreifen zu Chemie-Rohstoffen, besonders durch Pyrolyse. *Angew. Chem.* **1976**, *88* (22), 737–750.
- Shlensky, O. F.; Vaynsteyn, E. F.; Matyukhin, A. A. Dynamic Thermal Decomposition of Linear Polymers and its Study by Thermoanalytical Methods. *J. Therm. Anal.* **1988**, *34*, 645–655.
- Straus, S.; Wall, L. A. *J. Res. Nat. Bur. Stand.* **1961**, *65A*, 221.
- Stuetz, D. E.; Diedwardo, A. H.; Zitomer, F.; Barnes, B. P. Polymer Combustion. *J. Polym. Sci., Part C* **1975**, *13*, 585–621.
- Suuberg, E. M.; Peters, W. A.; Howard, J. B. Product Composition and Kinetics of Lignite Pyrolysis. *Ind. Eng. Chem. Process Des. Dev.* **1978**, *17*, 37–46.
- Urzendowski, S. R.; Guenther, A. H. Kinetics Constants of Polymeric Materials from Thermogravimetric Data. *J. Therm. Anal.* **1971**, *3*, 379–395.
- Wagenaar, B. M. The Rotating Cone Reactor for Rapid Thermal Solids Processing; University of Twente: Enschede, The Netherlands, 1994.
- Wall, L. A.; Madorsky, S. L.; Brown, D. W.; Straus, S.; Simha, R. The Depolymerisation of Polymethylene of Polyethylene. *J. Am. Chem. Soc.* **1954**, *76*, 3430–3437.
- Westerhout, R. W. J.; Kuipers, J. A. M.; van Swaaij, W. P. M. Measurement and Modeling of the High Temperature Pyrolysis Kinetics of PE and PP - Application of a Novel Screen Heater with a Gas Sweep. To be published.
- Wigmans, T.; van Cranenburgh, H.; Elfring, R.; Mouljin, J. A. Mass Transfer Phenomena during Potassium Carbonate Catalysed Carbon Steam Gasification Reactions in a Microbalance Setup. *Carbon* **1983**, *21* (1), 23–31.
- Wu, C.-H.; Chang, C.-Y.; Hor, J.-L.; Shih, S.-M.; Chen, L.-W.; Chang, F.-W. On the Thermal Treatment of Plastic Mixtures of MSW: *Pyrolysis Kinetics. Waste Manage.* **1993**, *13*, 221–235.

Received for review August 14, 1996
 Revised manuscript received March 1, 1997
 Accepted March 8, 1997*

IE960501M