



## The 5 MW DeepWind floating offshore vertical wind turbine concept design - status and perspective

**Schmidt Paulsen, Uwe; Aagaard Madsen , Helge; Kragh, Knud Abildgaard; Nielsen, Per Hørlyk; Baran, Ismet; Ritchie, E.; Leban, K.M.; Svendsen, H.; Berthelsen, P.A.; Bussel, G.J.W.van**

*Total number of authors:*  
12

*Published in:*  
Proceedings - EWEA 2014

*Publication date:*  
2014

*Document Version*  
Publisher's PDF, also known as Version of record

[Link back to DTU Orbit](#)

### *Citation (APA):*

Schmidt Paulsen, U., Aagaard Madsen , H., Kragh, K. A., Nielsen, P. H., Baran, I., Ritchie, E., Leban, K. M., Svendsen, H., Berthelsen, P. A., Bussel, G. J. W. V., Ferreira, C. S., & Chrysochoidis-Antos, N. (2014). The 5 MW DeepWind floating offshore vertical wind turbine concept design - status and perspective. In *Proceedings - EWEA 2014* European Wind Energy Association (EWEA).

---

### General rights

Copyright and moral rights for the publications made accessible in the public portal are retained by the authors and/or other copyright owners and it is a condition of accessing publications that users recognise and abide by the legal requirements associated with these rights.

- Users may download and print one copy of any publication from the public portal for the purpose of private study or research.
- You may not further distribute the material or use it for any profit-making activity or commercial gain
- You may freely distribute the URL identifying the publication in the public portal

If you believe that this document breaches copyright please contact us providing details, and we will remove access to the work immediately and investigate your claim.

# The 5 MW DeepWind floating offshore vertical wind turbine concept design - status and perspective

U.S.Paulsen DTU. Department of Wind Energy uwpa@dtu.dk	H.A.Madsen DTU Department of Wind Energy hama@dtu.dk	K.A.Kragh DTU Department of Wind Energy knkr@dtu.dk	P.H.Nielsen DTU Department of Wind Energy phni@dtu.dk	I.Baran DTU Department of Mechanical Engineering isbar@mek.dtu.dk
E.Ritchie AAU Department of Energy Technology ier@et.aau.dk	K.M.Leban AAU Department of Energy Technology kle@et.aau.dk	H.Svendsen SINTEF Energy Research harald.svendsen@sintef.no	P.A.Berthelsen MARINTEK p.a.berthelsen@marintek.sintef.no	
G.J.W.van Bussel TUDelft Wind Energy Research Institute g.j.w.vanbussel@tudelft.nl		C.S.Ferreira TUDelft Wind Energy Research Institute c.j.simaoferreira@tudelft.nl		N.Chrysochoidis-Antsos TUDelft Wind Energy Research Institute chrisoconicko@hotmail.com

Keywords: Vertical-axis wind turbine, offshore floating platform, DeepWind, aerodynamics, hydrodynamics, pultrusion, structural optimization, floater, permanent magnet generator, magnetic bearings, controls, safety

## Abstract

Floating vertical-axis wind turbines for offshore wind energy present a concept with novelty and potentials for reducing COE. Cost reduction for offshore wind power plants is an industrial challenge, and DeepWind is - as the analysis of the current design shows - believed to be a good candidate in achieving this.

In the paper the current design status of the 5 MW DeepWind concept is presented. The intended siting for the turbine is off the Norwegian west coast at about 250 m of sea depth. Focus is set on the integrated design highlighting structural benefits of the light rotor, the hydrodynamic aspects of the floating hull, and new generator design embracing magnetic bearings.

Two important design tools were developed which allow the industry to analyze various VAWT (vertical Axis Wind Turbine) variants for offshore applications: a main design tool "HAWC2" for aeroelastic design of VAWTs, and a generator design tool "NESSI". HAWC2 has been adopted for VAWT rotors by DTU Wind Energy in the project and is explained on its technical capability to embrace integrated modeling of the different

physical aspects. NESSI, developed at AAU (Aalborg University) is presented with focus on key elements in generator design.

The paper presents new developments in the current design of a novel rotor shape with overspeed control. Rotor performance, design structural key figures and upscaling potential are reported. New results implemented on permanent magnets generator and - bearing technology show, that it is possible to achieve a competitive design ready for further industrial optimization. A preliminary analysis is provided on the emergency philosophy for this concept.

## 1 Introduction

The need for renewable energy supply has increased focus on developing more efficient wind power plants that are less costly compared to concepts which from a design point of view are transformed from onshore to offshore conditions. Offshore COE is previously reported to be at least twice as expensive compared to onshore installations [1]. In particular floating offshore wind power plants are starting to emerge on the market with prototypes such as spar buoy, semi-submersible and TLP foundations with competitive

horizontal-axis wind turbines (HAWTs). As indicated in Figure 1, there are cost differences of about 20% between current HAWT technologies with bottom fixed foundations, and floating HAWT concepts [2]

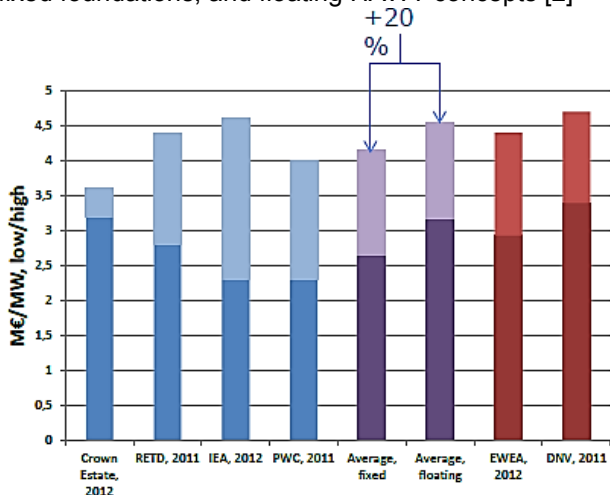

Figure 1 Cost estimates for bottom fixed structures (blue) and floating structures (red) [2]

The need to drive costs further down has initiated design towards radically new technologies, such as to use conventional platforms in combination with vertical-axis wind turbine (VAWT). The DeepWind concept is a novel approach which combines a Darrieus rotor and a floating spar rotating in its entire length. Towards the sea bed at the end of the rotating platform a bottom fixed generator converts the power, and a torque absorption system distributes the loads to the sea bed. DeepWind presents a simple design with few components (without nacelle) and with good balancing properties, omnidirectional operation with respect to wind direction, light weight rotor and O&M potentials. Figure 2 gives an impression of the two concepts.

This paper informs about the latest achievements in design of the 5 MW DeepWind concepts: Description of the main components, development status of design tools, technological solutions on challenges, and cost related issues in this area of radical new technologies.

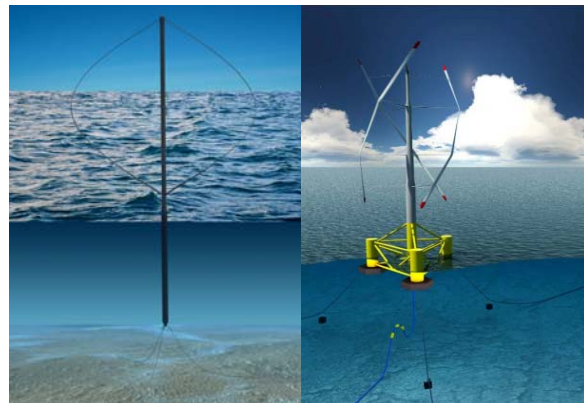

Figure 2 Artistic View Of Radical New Technologies. Left: Deepwind Concept. Right: Vertiwind (Nenuphar)

## 2 Design aspects of the concept

### 2.1 Current design overview

Compared to previous designs, the current design is significantly different. The rotor shape was changed [3] to a modified Troposkien shape with NACA0018 profile at the equatorial section, and at the root sections NACA0025 to ensure that the blade root sections can withstand the bending moments.[4]. This way, the center sections of the blades can remain slender resulting in a lighter structure with less drag than would have been possible with the previous shape. The blade shape and blade sectioning schematic of the current 5MW turbine is shown in Figure 3, Figure 4, respectively.

In Table 1 main dimensions and operation data is given. In the following sections, each member of the structure (rotor, floater, generator, and electrical system) is described. The current design has been successfully tested through full aero-hydro-servo-elastic simulations using HAWC2 [5] in IEC normal turbulence (IEC class C) at wind speeds within the normal operating range and at four sea states (wave and current) representative for the suggested deployment site, see Table 2 [6]. From overall design considerations not to compromise performance significantly during operation, a static rotor inclination up to 10 Degrees is intended.

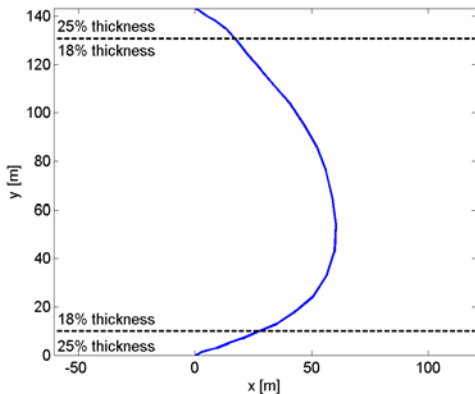

Figure 3 DeepWind modified troposkien rotor blade shape[6]

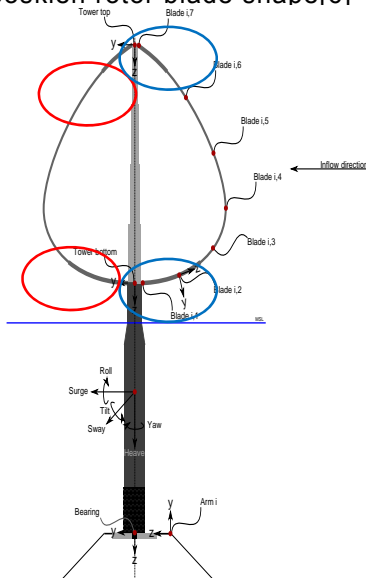

Figure 4 Schematic overview of 5MW DeepWind, with indication of blade connections (circles) and movement nomenclature

## 2.2 Blades

In parallel with the aerodynamic and structural design of the present 5MW design, novel asymmetrical airfoils have been developed at TUDelft, which provide very interesting opportunities to improve both the structural and aerodynamic properties of the Deepwind design [7]. For structural optimization the thickness ratio ( $t/c$ ) is a key parameter. Increasing the standard NACA00 airfoils “building height” ( $t/c \sim 18\%$ ), without further modifica-

Table 1 5 MW Deepwind main geometric and operational data

Operational and Performance Data		
Rated power	[MW]	5
Rated rotational speed	[rpm]	5.73
Rated wind speed	[m/s]	15
Cut in wind speed	[m/s]	4
Cut out wind speed	[m/s]	25
Geometry		
Rotor radius (R)	[m]	60.48
Rotor height (H)	[m]	143
Chord (c)	[m]	5
Solidity ( $\sigma = Nc/R$ )	[-]	0.1653
Swept Area	[m <sup>2</sup> ]	11996
Mooring line length	[m]	719.6

Table 2: Simulated sea states

Sea state	$H_s$ [m]	$T_s$ [s]	Current [m/s]	
			$V_0 < 14$ m/s	$V_0 > 14$ m/s
0	0	0	0	0
1	4	9	0.35	0.7
2	9	13.2	0.35	0.7
3	14	16	0.35	0.7

tion (e.g. NACA0021 or NACA0024 will lead to performance degradation, mainly due to additional pressure drag. Research at TU Delft [8] has shown that the combination of asymmetrical airfoils and larger thicknesses provides promising solutions for future VAWTs. One of the airfoils, designed with a genetic optimization algorithm for vertical axis wind turbines is the DU12W262[9]. A cross section of the airfoil can be seen in Figure 5.

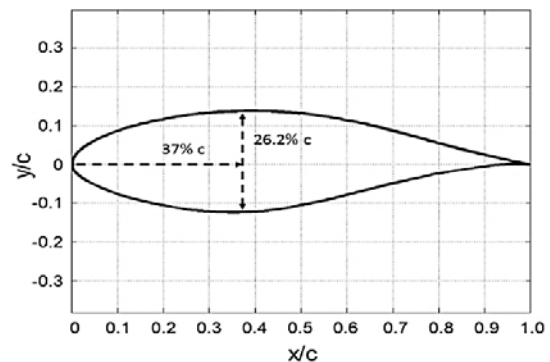

Figure 5 The DU12W262 airfoil dedicated airfoil for VAWT application

This 26% thick airfoil is designed and tested in the low turbulence wind tunnel of TUDelft up to a Reynolds(Re) number of  $1.0 \times 10^6$  [10]. A Re number which, unfortunately, still is significantly lower than the real Deepwind 5 MW Re numbers, but despite that, considered to be sufficiently high to validate the airfoil design in both steady and unsteady flow. The latter is of course very important due to the intrinsic unsteady operation of any VAWT airfoil.

Figure 6 shows a comparison of the performance of a 3-bladed VAWT equipped with NACA 0018 and DU12W262 airfoils respectively demonstrating its superior performance despite its larger thickness ratio. As can be seen there is an important performance enhancement at tip speed ratios  $\lambda=3.5-6$  in this specific configurations. Similar performance improvements are expected when this airfoil is applied in the 5MW Deepwind turbine, and that may also lead to a significant further reduction in the weight of the rotor, because of its improved structural properties.

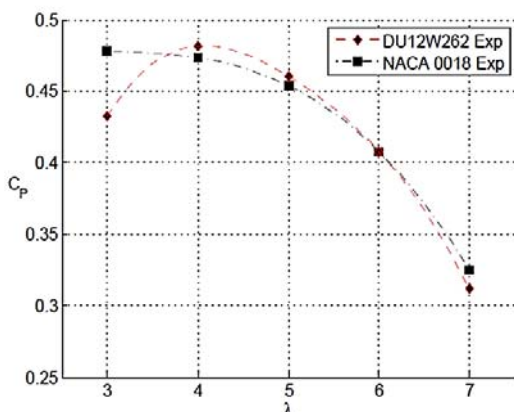

Figure 6 Comparison of the  $C_P$ - $\lambda$  curves of a three bladed VAWT equipped with NACA0018 and DU12W262 airfoils, respectively

Pultrusion is potentially a very efficient way to make very long constant chord GRP blades. A modelling tool has been developed for the pultrusion manufacturing method [11] in the DeepWind project. The curing of the matrix material can be analysed and questions with regard to size of specimens can be answered. A small scaled NACA0018 blade (100 mm chord length) was analysed in terms of degree of cure, temperature and process induced variations. The proposed numerical simulation tool has the potential to investigate the pultrusion of larger cross sections. According to the model and

the data from the pultrusion industry, a profile having a thickness of 60-80 mm can be pultruded successfully. This would be adequate for the 20 MW wind turbine for which it is assumed that the thickness of the blade is  $\sim 60-80$  mm. With regard to the capacity of the pultrusion machine, the largest pulling mechanism is an 80 ton device available in the market. Nevertheless, the product size depends on the application. In the pultrusion industry, a profile having a 3 m width has been pultruded successfully for a relatively simple geometry. In DeepWind, manufacturing the pultrusion die for larger cross sections ( $>7$ m), handling the creels and impregnating the massive reinforcements would be the main challenges to be considered in the project. Indeed, the quality of the pultrusion die (surface quality and roughness) directly affects the required pulling force and the product quality.

Larger blades are used close to the rotor axis due to the high stress levels. In DeepWind, the sectionized rotor concept has been developed [3] in which three pultruded blade profiles are connected to each other (see Figure 4). Several solutions for this connection are available such as using an adhesive for bonding the sections together. However, there is no available reference in the literature related to this bonding process. Another solution is to co-cure a mechanical connection to the pultruded blade profile. An example is shown in Figure 7, where a root section is pre-manufactured and co-cured with the blade for a large horizontal wind turbine.

This type of connection can be combined with a similar connection on the accompanying blade part as shown in Figure 4. For the Deepwind project the inner blade part may be manufactured with other techniques or materials as the outer blade part for lower costs or ease of assembly. The concept of assembly of blade sections with bolted connection is also known for large horizontal wind turbines [12].

## 2.3 Tower

The previous tower design included a uniform cross section. However, the tower is subjected to loads varying with height. Thus, the allowable tower stiffness also varies with the height. To accommodate the loads, a simple design with 4 sections of different diameter and wall thickness is suggested. The sectioning of the tower is indicated in Figure 4. Whilst remaining sufficiently stiff, the updated tower is now significantly lighter ( $\sim 75$  t) than the previous design.

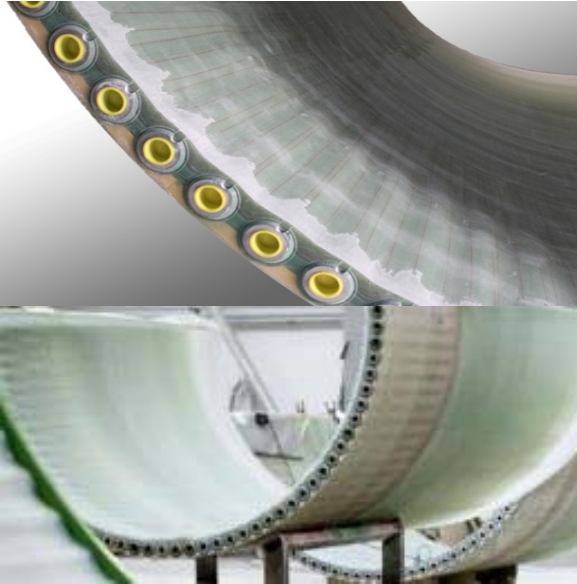

Figure 7 Pre manufactured root section (courtesy of SSP Technology A/S)

## 2.4 Floater

The stability of a free floating spar buoy relies primarily on gravity stability: the vertical distance between the mass center and the buoyancy center. Rotational stiffness is then obtained by having a non-homogenous mass distribution, i.e. a light voluminous upper part and a heavy lower part. Further, if we consider rotation about the center of gravity, COG and assume that the coupling between surge and pitch is weak; the pitch natural period can be approximated with the expression for the uncoupled resonance period:

$T_{n5} = 2\pi\sqrt{((I_{55} + a_{55})/k_{55})}$ , where  $k_{55}$  is the pitch stiffness, and  $I_{55}$  and  $a_{55}$  are the mass moment and added mass moment of inertia, respectively.

To avoid resonance motions of the spar buoy, the natural periods should be tuned to be larger than the wave periods with significant energy. Increasing the pitch natural periods can be done by either increasing the mass moment of inertia (and added mass moment of inertia) or decreasing the stiffness. Decreasing the stiffness may have adverse effect on the restoring "stability" of the system, e.g. it may result in excessive heeling of the platform. Lowering the center of gravity would increase stability, and this can be achieved by (re)moving mass from the upper sections and add mass to the lower sections, below COG. The mass moment of inertia can be increased by moving bulk of mass to the outer ends

of the spar buoy, further away from COG. Figure 8 shows how the vertical location of the rotor blade mass centre affects the pitch natural periods and static inclination angle. Lowering the mass centre reduces the static inclination angle, but also reduces the pitch natural period. This is given for a fixed floater size. A separate sensitivity study showed that optimizing the floater size for various blade mass centres reduced the cost of the floater. However, the cost reduction was only marginal. Similar cost reduction was obtained by reducing the mass of the blades and rotor tower.

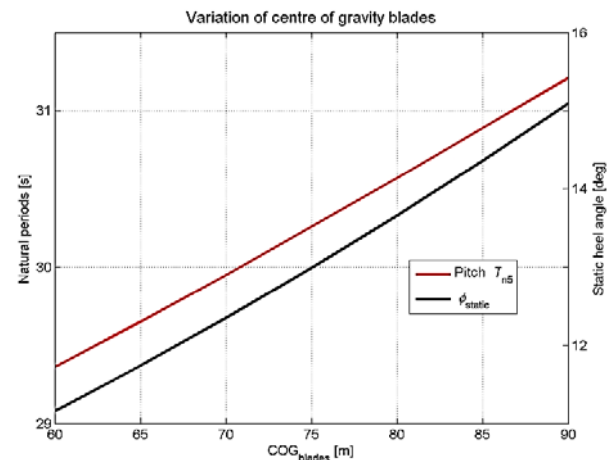

Figure 8 Effects on pitch natural period and tilt angle from COG

The deep draught of the spar buoy limits vertical wave forces such that the vertical motion of the spar buoy is small. For floating offshore wind turbines the upper part of the spar buoy is narrowed such that a small cross-sectional diameter is obtained in the wave zone, which limits the horizontal wave loads on the structure and contributes to a vertical resonance period well above the dominating wave periods (small water plane area).

A real, future application of the Deepwind floating turbine will be as part of a deep sea offshore wind farm. Additional question then arises regarding the layout of the wind farm and the concepts for grid connection. These questions are basically the same for other types of offshore wind farms. However, a significant cost for floating wind turbines is related to the anchoring points. It is therefore beneficial for multiple turbines to share the same anchoring points, leading to a hexagonal turbine layout.

## 2.5 Generator

The target of this research is to go up to 20 MW, ~3 rpm through a 5 MW, ~5 rpm preliminary design with a direct drive permanent magnet generator. These generator types are subjected to less maintenance, lower vibration levels and have high torque at low speeds. All together it makes the drive an attractive candidate for wind turbines [13]-[16]. The direct drive generators have more poles to cope with the relatively low speed of the shaft. As a consequence, these generators have large air gap diameters and consequently small pole pitches [17][18][19].

Direct drive low speed generators have the following challenges [5] that require attention during the design process [20][21]:

- high electromagnetic torque must be produced to balance the mechanical one from the turbine
- size of the generator is larger than in geared applications.
- large generator diameter implies manufacturing and transport difficulties
- When going up in power, a higher torque also requires a larger volume of the machine

In order to conveniently design this generator and other similar ones, the team has developed a design tool, enabling rapid evaluation of ideas and changes of specification requirements see Figure 9[22]. A direct drive, permanent magnet, three phase, radial flux generator was chosen [21], for the DeepWind generator after reviewing the relationship between size of the active materials and the required torque. Driven by the four quadrant converter this is able to act as starter motor and brake in addition to normal duty as a generator. To obtain the full load rated output voltage of 13.5 kV, a concentrated fractional slot pitch winding was selected. A sample sketch of a segment of the generator is shown in Figure 10. The active magnetic components form a cylindrical generator which is about 5.8m in diameter, and about 2.6 m in height.

**Bearings** The DeepWind operating conditions are characterized by bearing loads, shaft torque and -speed, ambient conditions and dynamic loadings, where bearings will be required to carry the loads

while the shaft is stationary during all operating conditions. The ambient conditions include the water pressure and temperature, the chemical composition of the water and the presence of life in the water. In order to design a magnetic bearing that supports the shaft reliably in the housing, it will be necessary to control the forces generated by the bearings.

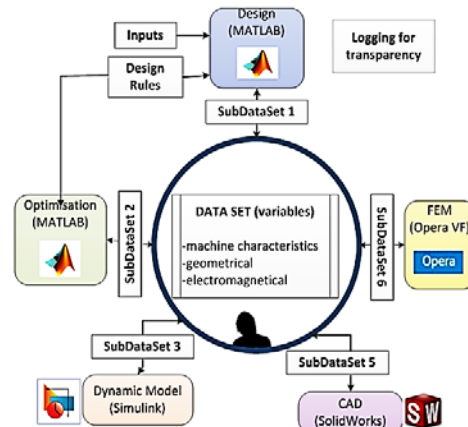
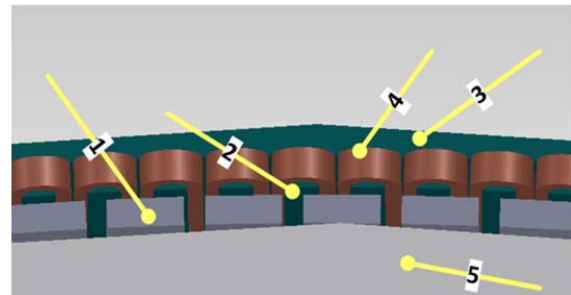

Figure 9: Deep Wind design tool concept[22]

The controlled or active magnetic bearing was chosen for study because it can be controlled to respond well to the changing loading conditions expected in the DeepWind application. Disadvantages are that it will require a control system and power supply, and the windings will need to be insulated and may require maintenance [6]. We suggest several bearing solutions; the main difference is whether the bearing, the generator and the enclosure part have to be sealed from outside sea water or not.



Legend: 1Permanent magnet 2Stator tooth 3Stator back iron 4Winding coil 5Rotor back iron  
Figure 10 Sample segment of the radial flux synchronous generator

Considerations of how the encapsulating environment is designed depend also on

maintenance aspects as discussed later for the electrical installation. As the bearing loads may vary considerably with floater and generator design, a design tool was developed by the team to enable rapid evaluation of the journal and thrust bearings as required. This tool was validated on a purpose built laboratory test rig [6].

For the current 5 MW concept, a modular generator and bearing solution is available from main industrial manufacturers.

## 2.6 Electrical system

The direct drive permanent magnet synchronous generator with a full converter interface to the electrical grid is in line with current trends for large wind turbines. The choice of direct drive is inherent in the basic idea where the entire spar buoy acts as a rotor. Furthermore, a design with high reliability is crucial, because of the offshore and submerged location of the generator. A full converter between the generator and the grid decouples the frequencies and allows a high degree of controllability, ensuring exported power satisfies grid code requirements.

**Turbine speed control** In addition to maximizing energy production, important control objectives for the Deepwind speed controller are to avoid damaging overspeed, and to stop the large twice-per-revolution (2p) aerodynamic torque variations from transplanting into the electrical system and mooring lines. A baseline controller [23][24] has been developed that seems to achieve these objectives to a satisfactory degree. The controller is based on a simple PI loop with an additional notch filter for elimination of 2p variations. Measured and low-pass filtered torque is used to specify a reference speed, which is compared with a notch and low-pass filtered measurement of the speed. The error is fed into a PI controller, with gains partly scheduled for better overspeed control. The output is a reference torque for the generator. The notch filter removes the 2p frequency component of the measured speed, thereby allowing 2p speed variations to absorb the aerodynamic torque variations such that the generator torque reference is kept smooth and unaffected by the these 2p variations. This is shown in Figure 11.

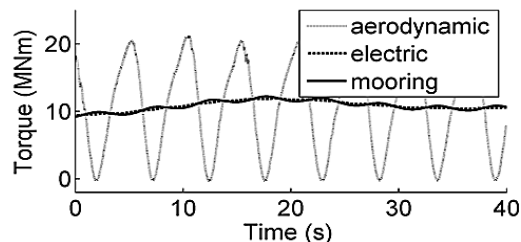

Figure 11 Elimination of aerodynamic torque variations. Simulation results with 14 m/s wind.

**Electrical layout** A special aspect of the DeepWind turbine is the submerged generator. This poses some challenges especially regarding maintenance of the electrical components. As failures in electrical parts are responsible for a significant share of wind turbine maintenance needs, this is an important issue. One proposal on how this could be facilitated, is to provide an access route via the rotor shaft, such that maintenance personnel can get down into the generator box, and equipment can be taken up or down, via an entrance at the sea surface. This approach requires that the encapsulating box is filled with air at atmospheric pressure. Another approach is to not allow direct access, but place the more critical electrical equipment such as power electronics and transformers in a separate module mounted below the generator box in such a way that it would be easy to disconnect and bring to the sea surface for maintenance actions. In this case, generator and converter boxes could have the same pressure as the surrounding water. Because the DeepWind generator is located at the bottom of the spar there is less concern for weight reductions, and including a transformer is not seen as a problem. The main issue is related to maintenance, as discussed above. To minimize the need for maintenance of submerged electrical parts, one could also consider floating platforms containing the electrical equipment. The current 5 MW generator design has an output voltage of 16 kV, which means power can be transmitted over modest distances without a step-up transformer. However, in a wind farm with several turbines connected along a feeder, higher voltage levels are generally applied. The inclusion of a transformer to obtain the industry standard voltage level is not considered to be a critical issue.

Electrical design including the control system has so far been focusing on the 5 MW case. The



suggested baseline controller is very generic and with re-tuned parameters it is expected, but not yet verified, to be applicable also for the 20 MW case. The electrical system is not expected to be a barrier for a Deepwind 20 MW turbine. At least the up-scaled design should not be fundamentally different from the 5 MW case.

## 2.7 The Safety System

The Deepwind concept has a safety system in development. This safety system should satisfy a safe shutdown of the wind turbine in case of abnormal internal or external conditions. The most important target is to prevent overspeeding situations. The current safety system is designed having two levels of authority.

In normal conditions this is taken care of by the turbine speed controller, but in case of grid failure, the first level safety system takes command and shuts down the wind turbine. The way to achieve this is by connecting the generator directly to a sea water cooled electrical dump load located inside the spar buoy. Initial calculations show that an engineered dump load, together with the assistance of a small mechanical parking brake, is sufficient to bring the wind turbine to a full stop within 30 seconds even if the turbine is rotating at max operational speed in winds close to cut-out wind speed.

An advantage of the Deepwind turbine is its huge rotational moment of inertia to which both the rotor and the spar buoy contribute significantly. Simplified but not yet verified calculations allow to use a time delay of approximately 5-7 seconds, e.g. the time between the detection of a control system failure or a cable or grid connection failure and safety system action. In case of using the dump load, 7 seconds are more than sufficient, since the switching itself can be done within 1-2 seconds, and also the detection of loss of load can be done within one second.

In case there is a generator failure or in case the dump load switch fails a second, higher level of authority safety system is needed. Here the final decision has to be made. At present a multi-criteria analysis of possible options is performed. The initial results show two possible ways to implement such high level safety system. One system is using blade spoilers to increase the drag of the rotor such that all aerodynamic power is destroyed. The second promising option is sinking the complete Deepwind

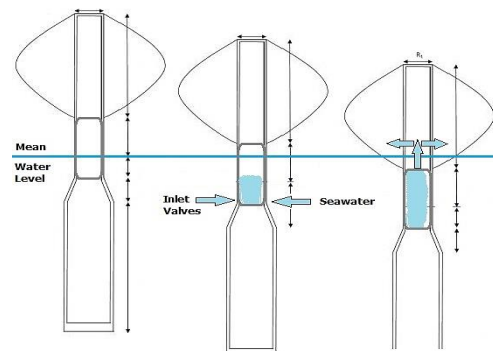

Figure 12 Sinking the complete wind turbine as a safety procedure in case of generator break down

turbine by allowing the floater to get filled with sea water. The deployment of the high level safety system is triggered with that an over speed condition is reached. Preliminary calculations show that by implementing a number of valves in the floater, opening the valves allows the sea water to enter the spar buoy and results in the sinking of the spar buoy at a sufficient draught in 5-6 seconds, see

Figure 12. Calculations indicate that this operation brings the turbine to complete stop or to very low and safe rotational speeds within the next 30 seconds by the blades hitting the sea surface. This idea has already been proven with the Deepwind demonstrator tests in Roskilde fjord in 2012. The maximum sinking depth to avoid the twisting of the mooring lines is 65 m. while the required depth is 36 m. This 36 m. corresponds with 50 degrees of "rotation" of the mooring arms, which is acceptable.

## 3 Results and discussion

A selection of results from the aero-hydro-servo-elastic simulations are presented to illustrate the performance of the current design with simulations performed in HAWC2.

An important design requirement for floating offshore structures is that the natural periods of the rigid body motions of the structure do not coincide with the dominating wave periods. This is checked by calculating the rigid body periods of the floating DeepWind structure (mooring system included) and

analyzed using HAWC2's build-in eigenvalue solver. The estimated periods are presented in Table 3.

Conventional floating platform used in the oil and gas industry have natural heave periods down to 20 seconds, and roll/pitch periods down to 30 seconds. Significant larger periods in roll and pitch will require a larger spar buoy, which again will be more costly.

Table 3 Natural periods of the rigid body motions

Body motion	$T_n$ [s]	Log.dec. [%]
Surge	97.1	1.59
Sway	95.2	1.55
Tilt	30	2.92
Roll	29.9	2.86
Yaw	27.6	0.14
Heave	27.2	0.16

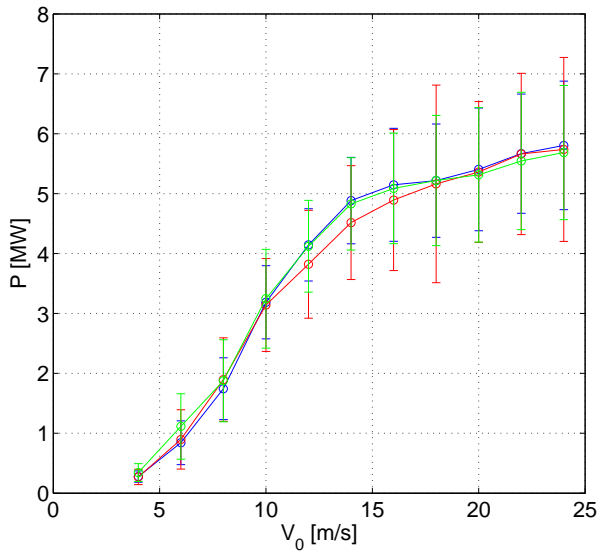

Figure 13 Generator Power. Blue: Sea state 1, red: Sea state 2, green: Sea 3. The circles represent the mean values, whereas the whiskers represent the standard deviation.

Within the current constraints, the layout of the DeepWind floater seems to be within the design requirements, but the final tuning will be dependent on the final inclusion of the reduced tower mass/changed COG and generator-bearing-enclosure module in tuning the floater.

From Figure 13 is seen that the turbine is producing

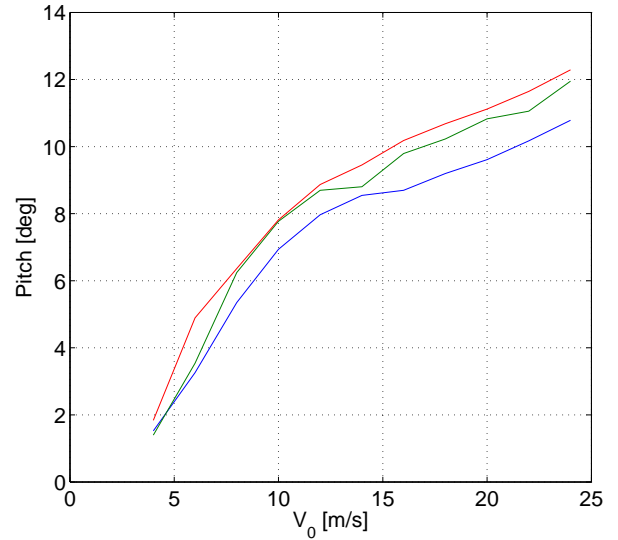

Figure 14 Pitch of rotor. Blue: Sea state 1, red: Sea state 2, green: Sea state 3.

the expected mean power at all sea states. The large variations of the power are due to the 2P variations of the aerodynamic torque which are unavoidable for a 2 bladed VAWT.

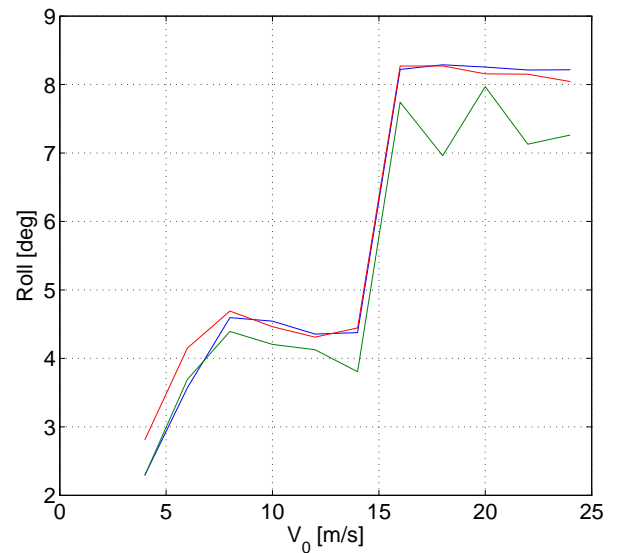

Figure 15 Roll of rotor. Blue: Sea state 1, red: Sea state 2, green: Sea state 3.

Figure 14 shows that the turbine pitches increasingly as the wind speed increases, which is also expected because the thrust increases with the

wind speed. The roll behavior of the turbine that is seen in Figure 15 might appear peculiar because there is a significant increase in the roll angle for wind speeds above 14 m/s.

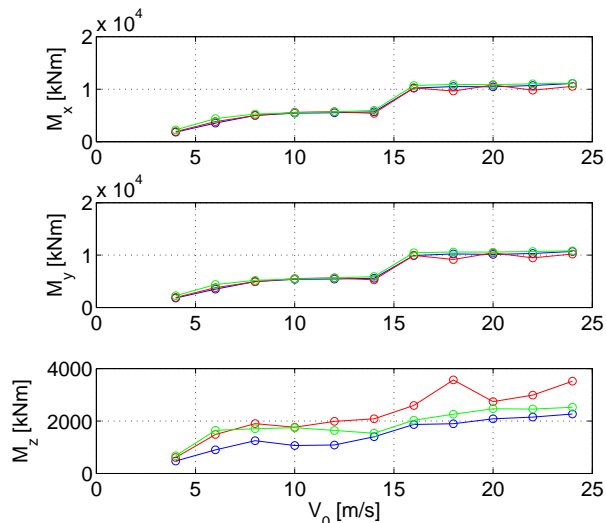

Figure 16 1 Hz damage equivalent shaft moments. Blue: Sea state 1, red: Sea state 2, green: Sea state 3.

However, this is easily explained by the Magnus force that is proportional to the sea current. The simulated sea states are defined with a discrete increase in current at 14 m/s. Thus a discrete increase in the roll angle, which is mainly affected by the Magnus force, is also expected around 14 m/s. Inspecting the damage equivalent moments from

## 4 Concluding remarks

The paper presented a 5 MW DeepWind concept design with practical solutions that can be utilized by a manufacturer, to continue with further optimization of main components and solutions to particularly safety issues, and electrical connectivity. The global modeling approach of the concept provides results which show no signs of instability, and selected results from the simulations shown in Figure 13 - Figure 16 demonstrate that the power curve, pitch, roll, and the 1 Hz damage equivalent moments in the generator shaft at the entrance to the generator, leaves no show stopper.

The 20 MW is far beyond current wind turbine sizes, so in terms of standards and availability of

components at the required ratings there are many open questions. But these are more related to market readiness and manufacturing than the technology itself.

## Acknowledgment

The present work is a result of the contributions within the DeepWind project, supported by the European Commission, Grant 256769 FP7 Energy 2010- Future emerging technologies, and by the DeepWind beneficiaries: DTU(DK), AAU(DK), TUDELFT(NL), TUTRENTO(I), DHI(DK), SINTEF(N), MARINTEK(N), MARIN(NL), NREL(USA), STATOIL(N), VESTAS(DK) and NENUPHAR(F).

## References

- [1] The Economics of Wind Energy. Report by EWEA 2009
- [2] The Crown Estate. The Crown Estate – UK Market Potential and Technology Assessment for floating offshore wind power. *The Crown Estate* (2012)
- [3] Vita L. Offshore floating vertical axis wind turbines with rotating platform. PhD thesis, Risø DTU, Technical University of Denmark, August 2011. PhD-80(EN).
- [4] Paulsen US, Madsen HA, Hattel JH, Baran I, Nielsen PH. Design optimization of a 5 MW floating offshore vertical-axis wind turbine. *Energy Procedia* 2013. 35; 22-32.
- [5] Larsen TJ, Hansen AM. How to HAWC2, the user's manual. Tech. Rep. Risø-R-1597(ver.4-3) (EN), DTU Wind Energy, Roskilde, Denmark, April 2012.
- [6] Paulsen US, Madsen HA, Hattel JH, Baran I, Nielsen PH, Ritchie E, Leban K, Svendsen H, Berthelsen AP DeepWind-from idea to 5 MW concept *Energy Procedia*, Submitted 2014
- [7] Simão Ferreira, C. and Geurts, B. Aerofoil optimisation for the vertical axis wind turbine, *submitted to Wind Energy*. (2013).
- [8] Simao Ferreira, C. The near wake of the VAWT: 2D and 3D views of the VAWT aerodynamics. PhD thesis, Delft University of Technology. ISBN/EAN:978-90-76468-14-3. (2009).
- [9] Simao Ferreira, C. and Geurts, B. Aerofoil optimisation for vertical axis wind turbines. *submitted to Wind Energy*(2013)

- [10] Ragni, D., Simão Ferreira, C. Correale G. "Experimental investigation of an optimized airfoil for vertical axis wind turbines", *Wind Energy*. submitted 2014
- [11] Baran I, Tutum CC, Hattel JH. The internal stress evaluation of the pultruded blades for a Darrieus wind turbine. *Key Eng. Mat.* 2013; 554-557: 2127-2137.
- [12] Investigation of potential extreme load reduction for a two-bladed upwind turbine with partial pitch," Taeseong Kim, Torben J Larsen, and Anders Yde, *Wind Energy*, submitted 2013.
- [13] Bilgili M, Yasar A, Simsek E. Offshore wind power development in Europe and its comparison with onshore counterpart. *Renewable and Sustainable Energy Reviews* 2011;15:905-15.
- [14] Semken RS, Polikarpova M, Roytta P, Alexandrova J, Pyrhonen J, Nerg J et al. Direct-drive permanent magnet generators for high-power wind turbines: Benefits and limiting factors. *Renewable Power Generation*, IET 2012;6:1-8.
- [15] Stander JN, Venter G, Kamper MJ. Review of direct-drive radial flux wind turbine generator mechanical design. *Wind Energy* 2012;15:459-72.
- [16] Bang D, Polinder H, Shrestha G, Ferreira J. Review of generator systems for direct-drive wind turbines. 2008:1-11.
- [17] BANG D. Design of Transverse Flux PM Machines for Large Direct-Drive Wind Turbines. Busan, Korea: Master of Engineering, Pukyong National University, 2010. ISBN 978-90-5335-336-3.
- [18] Deok-je Bang HP. RESEARCH REPORT on Rough Design of 10 and 20 MW Direct-drive Generators (Deliverable No.: D 1B2.b.hp1, 2008).
- [19] Li H, Chen Z. Overview of different wind generator systems and their comparisons. *Renewable Power Generation*, IET 2008;2:123-38.
- [20] Maples B, Hand M, Musial W. Comparative Assessment of Direct Drive High Temperature Superconducting Generators in Multi-Megawatt Class Wind Turbines. Contract 2010;303:275-3000
- [21] Leban K, Ritchie E, Argeseanu A Design Preliminaries for Direct Drive under Water Wind Turbine Generator; Proceedings of 20th International Conference on Electrical Machines, ICEM 2012, September 2012, Marseilles, France; IEEE Catalog Number: CFP1290B-USB; ISBN: 978-1-4673-0141-1
- [22] Leban K, Ritchie E, Argeseanu A .Design Tool for Large Direct Drive Generators: *14th International Conference on Optimization of Electrical and Electronic Equipment - OPTIM 2014* -SUBMITTED
- [23] KO Merz, HG Svendsen, A control algorithm for the DeepWind floating vertical-axis wind turbine, *J. Renewable Sustainable Energy* 5 (2013) 063136, doi:10.1063/1.4854675.
- [24] HG Svendsen, KO Merz, Control system for start-up and shutdown of a floating vertical axis wind turbine, *Energy Procedia* 35 (2013) 33–42, doi:10.1016/j.egypro.2013.07.156.