

Micro Scanning Probe Array Memory (μ SPAM)

Mathieu Bolks^a, Ferdy Hanssen^b, Leon Abelmann^a, Paul Havinga^c,
Pieter Hartel^b, Pierre Jansen^b, Cock Lodder^a, Gerard Smit^c

^aSystems and Materials for Information Storage (SMI), MESA⁺ Research Institute

^bDistributed and Embedded Systems (DIES), Department of Computer Science

^cComputer Architecture and Embedded Systems (CAES), Department of Computer Science
University of Twente, P.O. Box 217, 7500 AE Enschede, The Netherlands

Abstract— The design for a new type of non-volatile mass storage memory is discussed. This new design, based on scanning probe techniques, combines the low volume and power consumption of the FlashRAM, with the high capacity of the hard disk. The small form factor of the device makes it an excellent candidate for mass storage in handheld embedded systems. Its hierarchical architecture allows us to make a trade-off between data-rate, access time and power consumption. The power consumption scales linearly with the desired data-rate, and is expected to be lower than what can be achieved with competing technologies.

Keywords— hardware, handheld devices, storage, energy consumption, computer architecture, probes

I. INTRODUCTION

THERE is a huge demand for storage media in portable embedded systems like PDAs, mobile phones, MP3 players, etc. Mass storage systems for these applications should have a *small form factor*, *high capacity*, *low price per bit* and most importantly, a *low energy consumption* [1]. Currently solid state memory such as EEPROM (FlashRAM) and miniature hard disks, such as the IBM microdrive [2], are used.

Mechanically addressed systems, such as the hard disk, have the advantage of a very low price-per-bit compared to solid state memories, which rely on their capacity on the state-of-the-art in large scale lithography. During the last decade the increase of areal density in hard disks has more than doubled that of solid state memory. This has been possible because of the mechanical addressing used in hard disks. The price per bit of a FlashRAM (1 \$/MB) is now 4 times that of the microdrive, and 200 times that of desktop harddisks, and the difference will continue to increase rapidly. It can therefore be expected that systems based on mechanical addressing will be the mass storage component of choice in future embedded systems

applications, just like it is in desktop applications today.

Current hard disk technology however also has its limitations. Assuming that the form factor can be made even smaller than the current microdrive (which is already a marvel of mechanical engineering), other factors inherent to the Winchester architecture of the hard disk will start to limit progress in the next decade. Limiting factors are the thermal stability of a single written bit, and the fact that the number of heads per side of a disk is limited. In combination with a writing speed which is fundamentally limited to about 1 GHz, this leads to a bad scaling of the hard disk architecture, with an ever increasing gap between capacity and performance (access-time and data rate).

Therefore an alternative design for storing data, based on probe and MEMS technologies, is being investigated by the magnetic data storage community (IBM, HP, Hitachi, Carnegie Mellon University). The key advantages of the probe technology are that, instead of one, thousands of heads can be used in parallel (probe arrays), and that the rotary motion of the disk is replaced by linear XY motion which allows for different seek and read/write times (seek fast, read slow) [3].

At the University of Twente we are aiming to realize a storage device with high capacity and low power consumption, based on magnetic data storage, within the μ SPAM project. In this paper we present the current design of the device and we make an initial estimate of its power consumption. The aim of this multidisciplinary exercise is to provide embedded system designers with projections of the μ SPAM performance and power consumption, and *vice versa* to indicate to the μ SPAM designers where improvements can be made.

II. ARCHITECTURE OF THE μ SPAM

THE μ SPAM is made out of two silicon wafers bonded to each other. One half contains the (magnetic) media (see paragraph II-A). A μ Walker (described in paragraph II-B) is used to move the medium. The other half consists of one large array of probes. One probe can read with a speed f_r of 10000 bits per second. The number of probes has to be high enough in order to get sufficient bandwidth. Paragraph II-C deals with the probes.

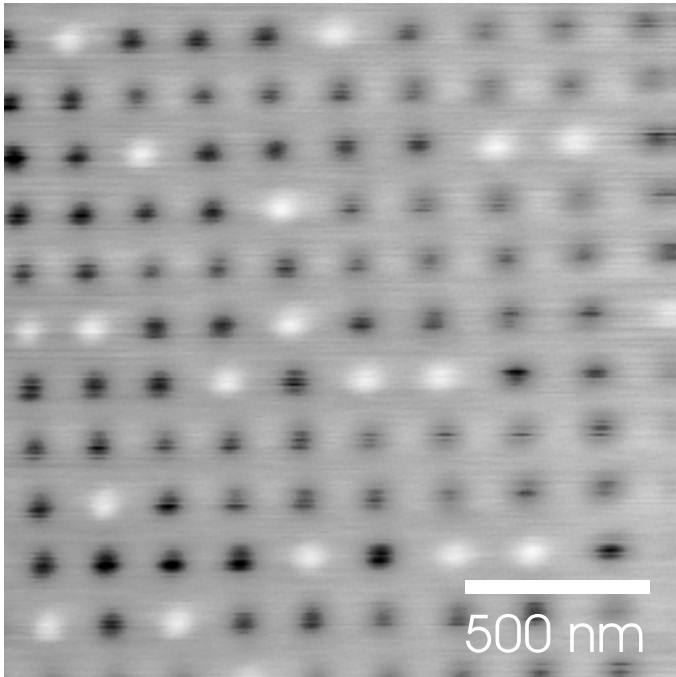

Fig. 1
MFM PICTURE OF AN ARRAY OF DOTS.

A. The medium

As the ultimate medium for the μ SPAM a regular matrix of magnetic single domain dots will be used. One dot represents one bit. A dot can be magnetized up or down. Such a discrete medium has several advantages over the continuous media used in the hard disk today. First of all it is expected that a discrete medium will suffer less from thermal instabilities, which eventually will allow much higher bit densities. However, more important is the ability of tracking at extremely high bit densities. Also a single domain dot enables an easier writing process.

We have already shown before that a matrix with a period of 200 nm can easily be achieved [4]. For this project however we are aiming at a period of 100 nm,

being 50 nm dot size and 50 nm spacing. This will give us a capacity of 10 Gbit/cm² (=65 Gbit/inch²). Figure 1 shows an MFM-picture of such a medium, this one with a period of approximately 250 nm. The black and white dots represent the up and down direction of the magnetization.

B. The μ Walker

Recently, at the [Micromechanical Transducers Group](#) a μ Walker, has been developed [5]. The μ Walker is a MEMS device, with a size smaller than 1 mm, which is able to walk over a surface. Figure 2 shows the principle of the μ Walker. One actuator

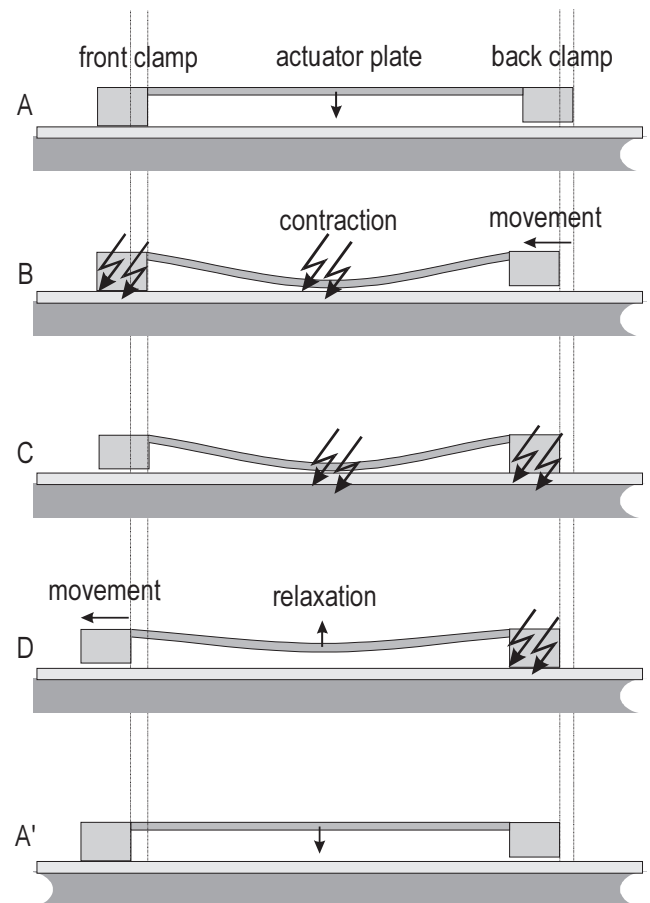

Fig. 2
ONE STEP OF A μ WALKER

plate and two clamps enables the device to make a simple walk step. First of all one clamp is actuated and shortly afterwards the actuator plate is attracted to the substrate (2-B). The actuator bends, and the second clamp moves towards the first clamp. With the actuator plate still bent, the second clamp is attached to the surface and the first clamp is released (2-C).

Now the plate will relax by moving the first clamp forward (2-D). The μ Walker now has made one step (2-A). A stepsize can be in the 10 to 100 nm range, large enough to overcome the distance between two dots (II-A).

Currently, the μ Walker is being adapted to carry a medium. The design is being changed to increase the size of the device to 1 mm and gain a higher speed and acceleration. Also, the μ Walker should be able to walk in two directions.

C. The probes

For reading, the MFM (Magnetic Force Microscopy)-principle has been chosen [6]. An MFM-probe is made by placing a small magnetic element, the tip, on a cantilever spring. Typical dimensions are a cantilever length of 200 μm , element length of 4 μm and diameter of 50 nm and a distance from the surface of 30 nm. Figure 3 shows the principle of an MFM-

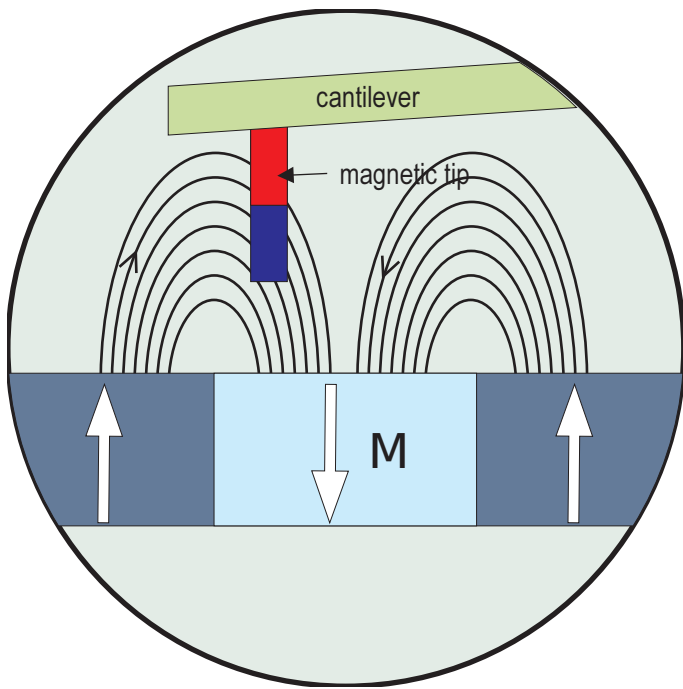

Fig. 3

THE PRINCIPLE OF AN MFM-MEASUREMENT

measurement. The magnetic tip is attracted or repelled, depending on the stray field of the medium. In this picture a continuous medium is drawn. However, we use a patterned one, but the principle remains the same. The tip is affected by the magnetic orientation of a dot. The displacement of the end of the cantilever can be measured by measuring capacity over the probe and the medium.

D. Estimate for a reasonably sized μ SPAM

With the size of one probe (100 μm) and the distance between the dots (100 nm), we can calculate there are 1000×1000 dots per probe, we call these parameters $D_x \times D_y$.

To read decently sized words, we assume a wordlength B_w of 64 bits. For a single bit error correction we need $B_c = 7$ correction bits [7]. Thus at least $B = B_w + B_c = 71$ bits total. It would seem that a 9×9 probe configuration for one μ SPAM-tile would be appropriate. It is a square, and 10 tips may break during manufacturing or use without rendering the tile useless. These parameters are called $P_x \times P_y$.

Furthermore, to achieve a sufficient high bandwidth an 8×8 tile configuration per μ SPAM chip would seem appropriate, we call these $T_x \times T_y$. At maximum speed this will give a 50 Mbit/s bandwidth, which is high enough for current multimedia applications. However, if a higher throughput of data is needed, the number of tiles can be increased. Figure 4 gives an overview of the design for the μ SPAM used throughout this paper. The parameters are summarized in table I. The total surface of such a μ SPAM chip would be approximately $8 \times 8 \text{ mm}^2$.

III. ENERGY CONSUMPTION

IN this section we give an estimate of the energy consumption of the μ SPAM in read mode. The system is now in the design stage, therefore we can only make reasonable assumptions about the power consumption of the different μ SPAM components. The aim of this exercise is to get a feeling for the relation between the power consumption and the desired data rate. At this stage it is only possible to give an order of magnitude estimate of the real values. We can recognize the following different subsystems.

A. Positioning

The positioning can be subdivided in *coarse* positioning for addressing the data (μ Walker) and *fine* positioning for probe height control and tracking.

For coarse positioning we assume that for each step of the μ Walker one bit is read per probe, i.e. the μ Walker makes steps equal to the bitlength λ (100 nm). Per step the central plate has to be pulled onto the medium and the clamps have to be activated. To estimate the power loss we assume that the energy stored in the capacitance ($\frac{1}{2}CV^2$) between the central plate and the medium, and the clamps and the medium is completely dissipated upon release. Most

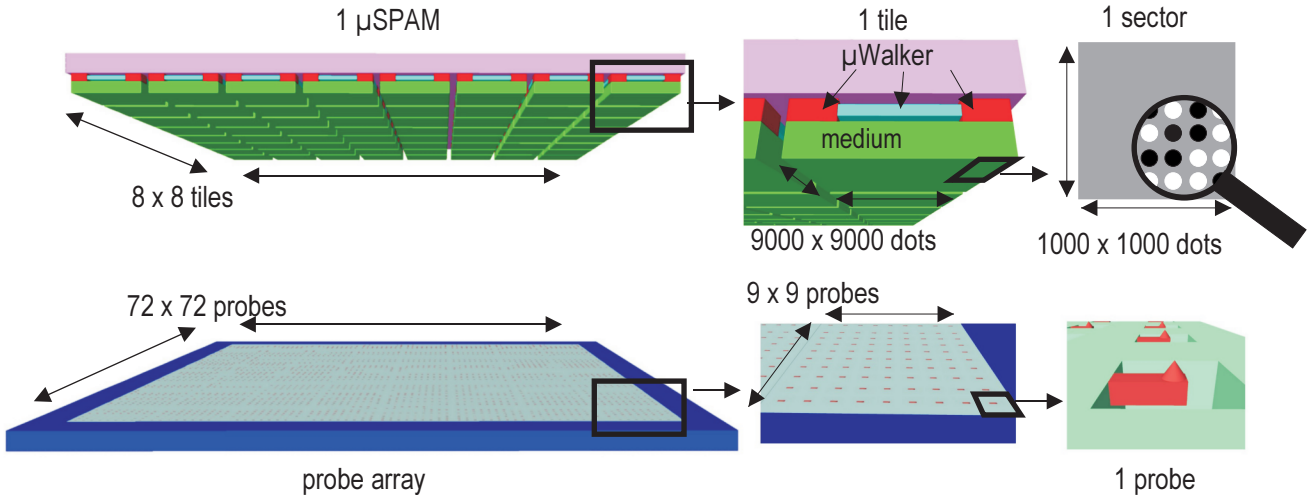

Fig. 4
LAYOUT OF THE μ SPAM

TABLE I
 μ SPAM SIZES

| Symbol | Description | Value | Dimensions |
|------------|------------------------|------------------|--|
| D_x, D_y | # dots/probe | 1000, 1000 | $100 \mu\text{m} \times 100 \mu\text{m}$ |
| P_x, P_y | # probes/tile | 9, 9 | $1 \text{ mm} \times 1 \text{ mm}$ |
| T_x, T_y | # tiles/ μ SPAM | 8, 8 | $8 \text{ mm} \times 8 \text{ mm}$ |
| B_w | # bits/word | 64 | |
| B_c | # correction bits/word | 7 | |
| B | # bits/read | $B_w + B_c = 71$ | |

energy is stored in the clamps, and for the current design of the μ Walker the power loss U_s is estimated to be 4.5 nJ per step. The power loss in idle mode, so when the μ Walker does not move, is assumed negligible (see appendix A).

For fine positioning the cantilevers of the probes, on which the read/write elements are mounted, have to move over a small distance to correct for height differences of the surface and to maintain correct tracking. Again we assume that the energy stored ($\frac{1}{2}k\Delta x^2$, where k is the spring constant and x is the displacement) in the cantilever as maximum deviation is completely lost upon release. Dissipation (U_P) is dominated by height control (see appendix B) and estimated to be $0.5 \cdot 10^{-15}$ J per bit.

B. Read process

Data is read by measuring the deflection of the cantilevers on which the small magnetic tips are mounted. Readout can be achieved in different ways. For a reasonable estimate of the power dissipated during reading, we assume that the cantilever deflection is measured by means of the capacitance between the probe end and the medium. We estimate that for 20 dB signal to noise ratio, about $1.5 \cdot 10^{-14}$ J is dissipated per bit read. We call this parameter U_r , see appendix C.

C. Electronics

We assume that for the probe level electronic circuits, most energy is needed for amplification. Following [8], the minimum energy required for amplification is either determined by the SNR of the amplifier, or the desired output impedance. In our case the bandwidth as well as the SNR are very small, so the mini-

mum power consumption is determined by the desired output power. Using

$$P_{sup} = \frac{2\pi kTB_a V_{sup} C_a}{q} \approx \frac{V_{sup} B_a C_a}{6} \quad (1)$$

with $V_{sup}=3$ V, $B_a = 10f_r$ and C_a approximately 1 pF we obtain for the energy dissipated in the read amplifier $P_{read} = 50 \cdot 10^{-12} f_r$, or 50 pJ per read bit.

Beside the amplification, there are also circuits needed for multiplexing on μ SPAM level. A general rule for a multiplexer is:

$$P_{MUX} = \sum (CV^2 f) \quad (2)$$

For dissipation at the inputs and the output we rewrite this to:

$$P_{MUX} = C_{m_i} V_{sup}^2 P_x P_y F_B f_r + C_{m_o} V_{sup}^2 F_B f_r B_w \quad (3)$$

Where C_{m_i} (=1 pF) and C_{m_o} (=5 pF) are the capacities for the input and output respectively.

The buffer memory itself is, when we assume a stream rate of approximately 1000 kbit/s, a word length of 32 bits, and a memory access time of 10 ns used for $\frac{1000 \cdot 10^3}{32} \times 10 \cdot 10^{-9} = 31 \cdot 10^{-5}$ seconds every second. Since SRAM only consumes power when it is used, we ignore the power consumption of the buffer memory itself [9].

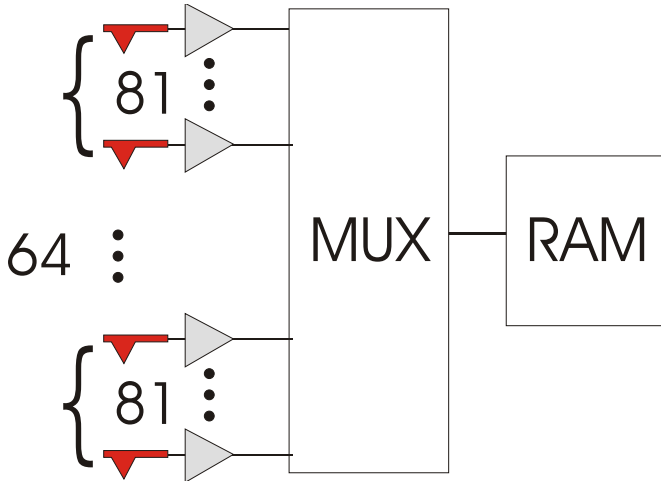

Fig. 5

AN OVERVIEW OF THE AMPLIFICATION, MULTIPLEXER AND BUFFERING PROCESS

Figure 5 gives an overview of the amplification, multiplexing and buffering process.

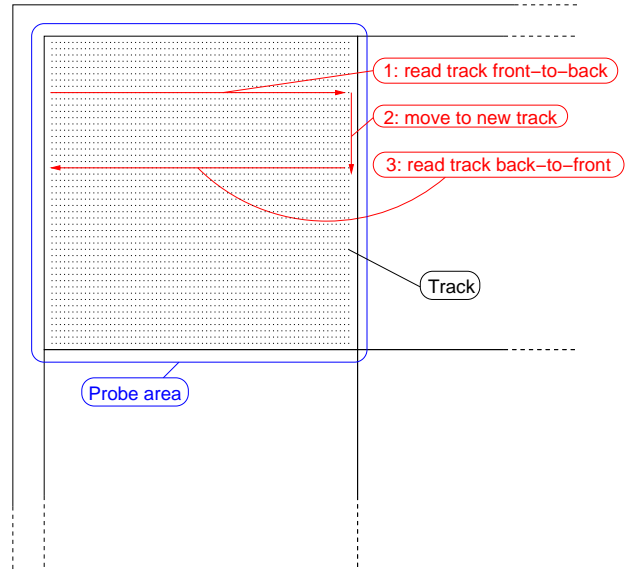

Fig. 6

TRACK LAYOUT OF A SINGLE μ SPAM TILE

IV. POWER DISSIPATION CALCULATIONS

WE calculate the amount of energy needed per second the following way. The tiles are organised into tracks. One track per probe consists of all dots in a row, so there are D_x , or 1000 dots, or bits, per probe. A track per tile consists of the tracks of all data probes put together, so a track is $D_x \times B_w = 64000$ data bits in size. Tracks are read front-to-back and back-to-front alternately. This layout is depicted in figure 6.

The energy needed to change to a new track is computed as follows (we assume a track change occurs to a random new track, so the amount of steps needed per track change averages to $D_y/3$):

$$U_{ts} = \frac{D_y U_s}{3} \quad (4)$$

The bandwidth per tile is controlled as follows. Reading at full speed one tile can accommodate a maximum data rate of $B_w \times f_r = 640$ kbit/s. When we do not need such a high bandwidth (e.g. an MP3-file only needs about a quarter of this), we simply do not read all probes f_r times per second. For example, suppose we want to read at a speed of 160 kbit/s, then we first read the first quarter of the probes, then the second

quarter, the third and the fourth. So we only have to take one μ Walker step every $f_r \times \frac{1}{4}$ seconds, and our multiplexer electronics can operate at a quarter of the maximum frequency. We use the symbol F_B (with $0 \leq F_B \leq 1$) to indicate this bandwidth factor, so our bandwidth from the relevant tile is always $F_B \times B_w \times f_r$.

The energy needed to read with a bandwidth factor F_B during a time of t seconds is computed as follows:

$$U_{r,f}(F_B, t) = F_B f_r t U_s \quad (5)$$

$$+ \frac{F_B f_r t U_{ts}}{D_x} \quad (6)$$

$$+ F_B f_r t B (U_P + U_r) \quad (7)$$

$$+ t \frac{B_a V_{sup} C_a}{6} P_x P_y \quad (8)$$

$$+ t \frac{1}{2} \frac{1}{2} C_{m_i} V_{sup}^2 P_x P_y F_B f_r \quad (9)$$

$$+ t \frac{1}{2} \frac{1}{2} C_{m_o} V_{sup}^2 F_B f_r B_w \quad (10)$$

Where formula (5) constitutes the steps of the μ Walker, formula (6) constitutes the energy required for changing tracks, formula (7) constitutes the actual reading of the probes with the fine correction in the z -direction, formula (8) constitutes the energy required for the amplifier electronics at each probe, formula (9) constitutes the energy dissipated by the capacitance of the wiring to the inputs of the multiplexer box, and formula (10) constitutes the energy dissipated by the capacitance of the wiring from the outputs of the multiplexer box to the buffer memory.

Formulas (5) and (6) all refer to mechanical energy consumption, formula (7) refers to the energy consumption of the actual reading of data, and formulas (8), (9), and (10) refer to the energy consumption of the electronics. In section V these three energy groups are considered separately.

When we are reading from one tile, the others are doing nothing, so the energy for a tile which is idling for t seconds is computed like this:

$$U_{T_i}(t) = f_r t U_{s_i} \quad (11)$$

We assume that the amplifier and multiplexer electronics of idle tiles are turned off, so they don't consume any power. Since the power loss of the idle μ Walker can be neglected, an idle tile is assumed to consume no power at all.

With the track model, the maximum bandwidth a single tile can accommodate can be calculated as follows:

$$W_{T,max} = B_w f_r \frac{D_x}{D_x + \frac{D_y}{3}} \quad (12)$$

When reading with a certain bandwidth, the number of tiles needed at full speed is called T_f , the one tile needed with a bandwidth between 0 and full speed is called T_{nf} , and the number of tiles idling is called T_i . The numbers T_f and T_i are calculated in the following way when W is the desired bandwidth:

$$T_f(W) = \left\lceil \frac{W}{W_{T,max}} \right\rceil \quad (13)$$

$$T_i(W) = T_x T_y - T_f(W) - 1 \quad (14)$$

The bandwidth needed on the non-full non-idle tile T_{nf} is computed with:

$$W_p(W) = \lceil W - T_f(W) W_{T,max} \rceil \quad (15)$$

Where W is the total bandwidth requested from the μ SPAM.

So the total energy usage for a total bandwidth W during t seconds can be computed as follows:

$$\mathcal{U}(W, t) = T_f(W) U_{r,f}(1, t) \quad (16)$$

$$+ U_{r,f}\left(\frac{W_p(W)}{W_{T,max}}, t\right) +$$

$$U_{T_i}\left(\frac{W_{T,max} - W_p(W)}{W_{T,max}} t\right) \quad (17)$$

$$+ T_i(W) U_{T_i}(t) \quad (18)$$

Where formula (16) constitutes the energy needed by the tiles providing full bandwidth, formula (17) constitutes the energy needed by the non-full non-idle tile T_{nf} , and formula (18) constitutes the energy needed by the idle tiles.

The power consumption, as a function of the desired bandwidth, can then simply be computed with:

$$\mathcal{P}(W) = \frac{\mathcal{U}(W, t)}{t} \quad (19)$$

To recapitulate, we have placed all quantities used for the calculation of $\mathcal{P}(W)$ in the appendix, table II.

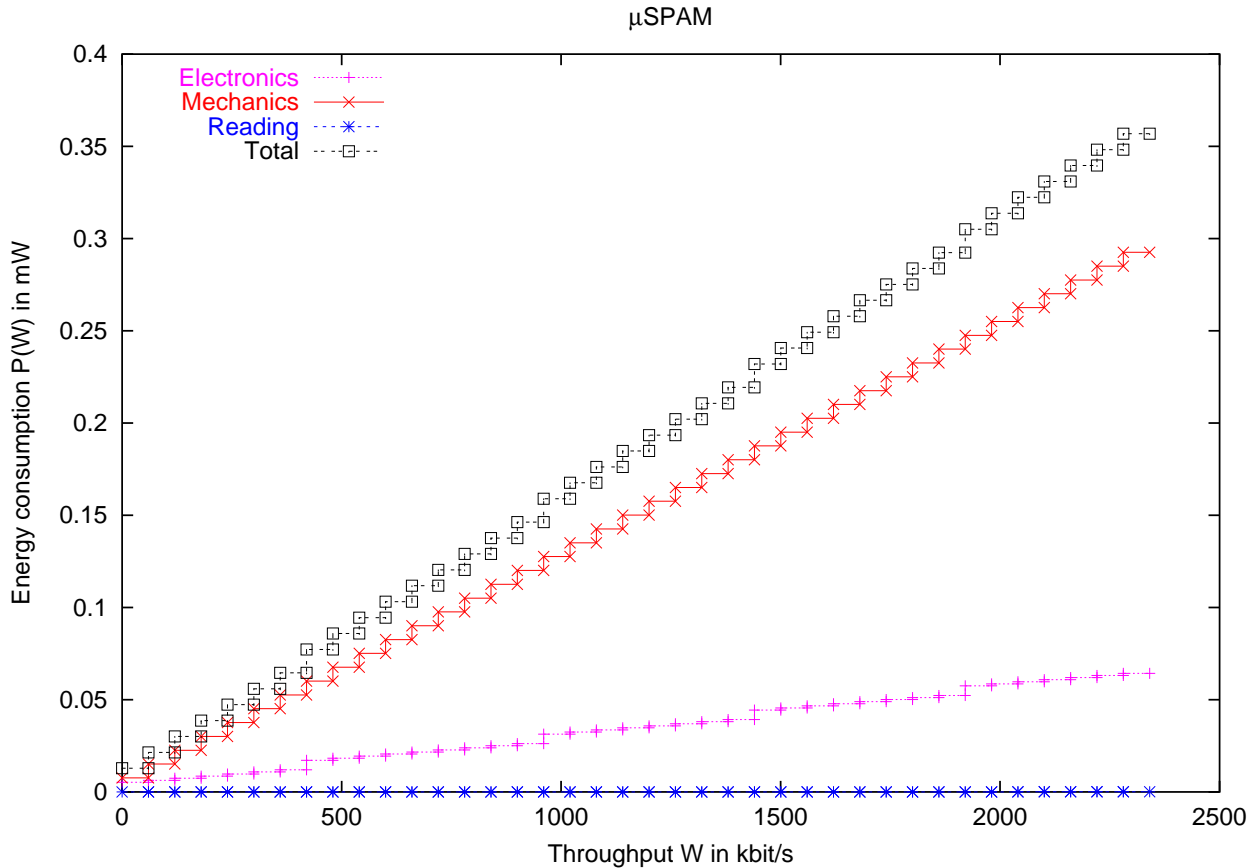

Fig. 7
ENERGY CONSUMPTION

V. RESULTS

IN figure 7 we have plotted the power consumption against the bandwidth, using formula (19) and all the numbers provided in the previous three sections. The bandwidth range has been chosen to show audio (128–256 kbit/s in MPEG-form) and video (1–2 Mbit/s in MPEG-form) bandwidth ranges. Figure 7 shows four lines:

- the line *Mechanics* shows the result of formula (19), where the value of $U_{r,f}(F_B, t)$ consists only of formulas (5) and (6);
- the line *Reading* shows the result of formula (19), where the value of $U_{r,f}(F_B, t)$ consists only of formula (7);
- the line *Electronics* shows the result of formula (19), where the value of $U_{r,f}(F_B, t)$ consists only of formulas (8), (9), and (10);

- the line *Total* shows the final result of formula (19), which equals the sum of the other three lines.

Figure 7 shows several interesting results. First it is clear that the power consumption of the actual reading of the probes is negligible. The power consumption of the actual μ Walker movements scales linearly with the requested bandwidth. The power consumption for the electronics takes small steps when we are increasing the use of a tile, but makes a bigger step when a new tile comes into play. So the power consumption of the μ SPAM scales with the bandwidth requirements.

Figure 7 also shows that the mechanical part consumes most of the power needed to operate the μ SPAM, approximately 80 percent, and the electronics consume the rest of the power.

VI. CONCLUSIONS

FIGURE 7 clearly shows that the power consumption of the μ SPAM increases linearly with the required data rate. This is a result of the fact that for higher data rates, simply more μ Walkers and probes are activated. This is an advantage over the hard disk architecture, where the disk rotates at maximum speed, no matter what data-rate is requested. As a consequence the power consumption of the μ SPAM scales much better with the desired data rate, especially for low data rate applications such as handheld audio/video players.

The linear increase in power consumption suggests that there might be a cross-over point at which the power consumption of the μ SPAM exceeds that of hard disks (such as the IBM microdrive). The preliminary estimates of the power consumption presented here do however not allow for a meaningful extrapolation.

Moreover the choice between the hard disk architecture and this new MEMS/probe based recording system not only depends on power consumption. The access time which can for instance be reached with the current μ Walker design is lower than in the hard disk. The shock resistance however will be better, since the mechanical resonance frequency of the components is much higher (compare the 100 μ m of the μ SPAM probe with the centimeters of the hard disk arm). Also the small form factor of the μ SPAM might be a big advantage, for instance in mobile phones. Last but not least also cost will be an important factor — the fact that the μ SPAM does not require much assembly nor the latest generation in lithography, indicates that cost could be low.

More precise conclusions require more detailed design and analysis. The preliminary calculations presented here show that the use of probe recording systems in low-power applications is certainly a route worthwhile for investigation.

ACKNOWLEDGEMENTS

WE would like to thank Remco Wiegerink and Edin Sarajlic of the Micromechanical Transducers Group and Bram Nauta of the IC-Design group for their contributions.

REFERENCES

- [1] G. J. M. Smit and P. J. M. Havinga. Lessons learned from the design of a mobile multimedia system in the Moby Dick project. In *Lecture Notes in Computer Science*, volume 1927, pages 85–99. Springer, September 2000.
- [2] IBM. IBM Microdrive family of one-inch drives. <http://www.storage.ibm.com/hdd/micro/>.
- [3] L. R. Carley, J. A. Bain, G. K. Fedder, D. W. Greve, D. F. Guillou, M. S. C. Lu, T. Mukherjee, S. Santhanam, L. Abelmann, and S. Min. Single-chip computers with microelectromechanical systems-based magnetic memory (invited). *Journal of Applied Physics*, 87(9):6680–6685, 2000.
- [4] M. A. M. Haast, I. R. Heskamp, L. Abelmann, J. C. Lodder, and Th. J. A. Popma. Magnetic characterization of large area arrays of single and multi domain conical multi-layer dots. *Journal of Magnetism and Magnetic Materials*, 193:511–514, 1999.
- [5] N.R. Tas, J. Wissink, A.F.M. Sander, T.S.J. Lammerink, and M.C. Elwenspoek. Modeling, design and testing of the electrostatic shuffle motor. *Sensors and actuators A (Physical)*, 70:171–178, 1998.
- [6] S. Porthun, L. Abelmann, and J. C. Lodder. Magnetic force microscopy of thin film media for high density magnetic recording. *Journal of Magnetism and Magnetic Materials*, 182(1-2):238–273, 1998.
- [7] R. W. Hamming. Error Detecting and Error Correcting Codes. *The Bell System Technical Journal*, XXVI(2):147–160, April 1950.
- [8] Johan H. Huijsing, Klaas-Jan de Langen, Ron Hogervorst, and Rudy G. H. Eschauzier. *Low-Voltage/Low-Power Integrated Circuits and Systems*, chapter 9. IEEE Press, 1998.
- [9] R. J. Evans and P. D. Franzon. Energy Consumption Modeling and Optimization for SRAM's. *IEEE Journal of Solid-State Circuits*, 30(5):571–579, May 1995.

APPENDIX

I. ENERGY CALCULATIONS

In this appendix the values for the calculations are justified.

A. Coarse positioning: steps of the μ Walker

In this simple model we assume the μ Walker takes 10000 steps per second of 100 nm each. We call this frequency f_r , which consequently is the maximum read frequency per probe. For one step of the μ Walker the actuator plate is bent once and a clamp is set twice. For the (electrical) energy of the plate we have:

$$U = \frac{1}{2} C V^2 \quad (20)$$

$$C = \frac{\epsilon_0 \epsilon_r A}{g} \quad (21)$$

Where $\epsilon_r = 1$, $\epsilon_0 = 8.85 \cdot 10^{-12}$ F/m, $A = 100 \mu\text{m} \times 200 \mu\text{m}$, $g = 2 \mu\text{m}$. If we choose a value of $1 \mu\text{m}$ for y and a voltage $V = 50$ V, then with formula (20) we get an energy of $2.2 \cdot 10^{-10}$ J for every step. Note: in practice y appears to be $0.88 \mu\text{m}$ and the plate bends, which has not been taken into account here.

For the clamps the situation is almost the same. Only now $\epsilon_r = 8$, $A = 600 \mu\text{m} \times 20 \mu\text{m}$ and instead of the gap we take the thickness of the siliconnitride ($0.5 \mu\text{m}$). This results in an energy consumption of $4.25 \cdot 10^{-9}$ J per step.

The total energy for one step of the μ Walker is thus $4.5 \cdot 10^{-9}$ J. We call this U_s , and it stands for a step in either the x - or the y -direction.

When the μ Walker does not move, the only energy dissipated is the leakage current of the clamps capacitors. Assuming a leakage current of 1 nA/cm^2 , the dissipation is estimated to be 6 pW per μ Walker, so can be neglected.

B. Fine positioning: tip correction

The correction in the z -direction takes place f_r (10000) times per second over a distance of about $\lambda/3$. With a spring constant of $k \text{ N/m}$ we get $U_{P_z} = 1/18k\lambda^2$ J per tip per correction. For $\lambda=100 \text{ nm}$ and a spring constant of 1 N/m we obtain $0.5 \cdot 10^{-15}$ J.

For the correction in the x - and y -direction we can distinguish between high frequency, small deflection correction, to correct for jitter in the dot positions and low frequency correction to correct for the angle between the track and the μ Walker axis. We estimate

the jitter at about $\lambda/10$ which has to be corrected at the data rate frequency f_r . The lateral correction does not have to be more than 2λ , because larger deviations can be corrected by cross-track steps of the μ Walker. At a misfit angle α of about 0.1° , the correction distance is $\lambda/\tan \alpha$, which corresponds to control bandwidth of $\tan \alpha f_r$, which is very small. The main contribution of the dissipation in fine control is therefore caused by the height control.

Of course the energy which is required to perform cross-track steps has to be included as well. This energy equals $U_s f_r \tan \alpha$, which corrects for all probes on a tile. This energy should in principle be added to the coarse positioning energy, but can for small α safely be neglected.

C. Reading

The simplest way to measure the capacitance between the probe and the medium is to include this capacitance in a series circuit with a resistance connected to an AC voltage source. The voltage drop over the resistance is a measure for the capacitance, which again is a measure for the probe/medium distance d : $\Delta C = C(1 - \Delta d/d)$. For optimum readout we take the measurement resistor R equal to the capacitor impedance $1/\omega C$, which results in a measurement signal $V_{sig} = V_{sup} \Delta d/d$ for small deflections.

The noise level of the measured signal is fundamentally limited by the Johnson noise in the measurement resistor to $V_N = \sqrt{4kTB R}$, where B is the measurement bandwidth. The desired signal to noise ratio (SNR) therefore sets an upper limit on value of R , and therefore a lower limit on the power dissipated in this resistor:

$$R < \frac{(\Delta d/d) V_{sup}^2}{(SNR)^2 4kTB}$$

$$P > \frac{(SNR)^2 4kTB}{(\Delta d/d)^2}$$

We expect a cantilever deflection Δd of about 1 nm , a distance d of about 30 nm . For a sufficiently low bit error rate a SNR of 10 (20 dB) is needed, with about 10 sample points per bitlength, so $B = 10f_r$. The minimum dissipated power per bit (P/f_r) than is $1.5 \cdot 10^{-14}$ J.

TABLE II
ESTIMATED QUANTITIES USED FOR THE CALCULATION OF $\mathcal{P}(W)$, IN ALPHABETICAL ORDER

| Symbol | Description | Value |
|---------------------|---|------------------------|
| B | total # bits per read | $B_w + B_c = 71$ |
| B_a | Bandwidth of a amplifier | 100 kHz |
| B_c | # bits needed for B_w -bit word for fault correction/recognition | 7 |
| B_w | # bits per word | 64 |
| C_a | Amplifier capacity | 1 pF |
| C_{m_i} | Multiplexer capacity at the input channel | 1 pF |
| C_{m_o} | Multiplexer capacity at the output channel | 5 pF |
| D_x, D_y | # dots/tip (x - & y -directions) | 1000, 1000 |
| f_r | read frequency per tip | 10 kHz |
| $\mathcal{P}(W)$ | power consumption of a single μ SPAM when reading with bandwidth W | — |
| P_x, P_y | # tips/tile (x - & y -directions) | 9, 9 |
| $T_f(W)$ | amount of full tiles needed to accomodate a bandwidth W | — |
| $T_i(W)$ | amount of idle tiles needed when accomodating a badnwidth W | — |
| T_x, T_y | # tiles/ μ SPAM (x - & y -directions) | 8, 8 |
| $\mathcal{U}(W, t)$ | energy usage for a single μ SPAM when reading with bandwidth W for t seconds | — |
| U_{P_z} | energy required for fine-correction per tip per dot (read + write) in z -direction | $0.5 \cdot 10^{-15}$ J |
| U_r | energy required for reading per tip per dot | $1.5 \cdot 10^{-14}$ J |
| $U_{r,f}(F_B, t)$ | energy required to read a tile for t seconds with bandwidth factor F_B | — |
| U_s | energy required for step of μ Walker (equal for both x - & y -direction) | $4.5 \cdot 10^{-9}$ J |
| U_{s_i} | energy required f_r times per second for μ Walker when it is idle | 0 J |
| $U_{T_i}(t)$ | energy required to keep a tile idle for t seconds | — |
| U_{ts} | average energy required to change to a new track | $1.5 \cdot 10^{-6}$ J |
| V_{sup} | Power supply of the integrated circuits | 3 V |
| W | bandwidth requested | — |
| $W_p(W)$ | bandwidth needed on the non-full non-idle tile T_{nf} to accomodate a bandwidth W | — |
| $W_{T,max}$ | maximum bandwidth a single tile can accomodate | 426.7 kbit/s |
| λ | bit length | 100 nm |