

Centre for
Telematics and
Information
Technology



University of Twente
The Netherlands

Mobile IP

Tutorial @ Eunice '99

September 1 - 3, 1999

Geert Heijenck

Centre for Telematics and Information Technology

University of Twente

geert.heijenck@ctit.utwente.nl

* parts of this presentation have been copied with permission from Charlie Perkins

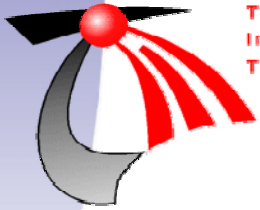

Outline

- **Why Mobile Internet?**
- **What is the Problem?**
- **Mobile IP**
 - Advertising Care-of Addresses
 - Registration
 - Tunneling
- **Mobile IP problems / extensions**
 - triangle routing
 - smooth handoff
- **Mobile IP for IPv6**
- **Conclusions**

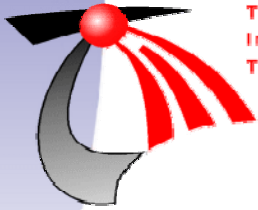

Why Mobile Internet?

- **Internet and the WWW are growing exponentially**
- **Many companies use Internet technology for their internal networks (Intranets)**
- **Increasing support for real-time e.g. voice communications using Internet technology**
- **Internet technology is the premier candidate for the core network of future mobile networks**

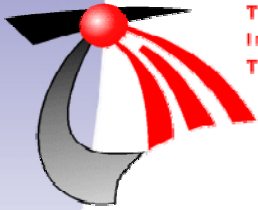

Why Mobile Internet? (2)

- **Wireless communications technologies suitable for packet data are becoming available**
 - IRDA
 - IEEE 802.11
 - Bluetooth
- **Voice oriented wireless communications technologies introduce data capabilities**
 - DECT
 - GSM --> GPRS
 - 2nd generation mobile --> 3rd generation mobile (IMT2000)

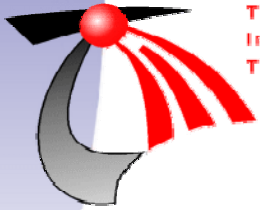

Why Mobile Internet? (3)

- Laptops are widely used
- Palmtops are becoming sufficiently powerful
 - TCP/IP stack running on PalmPilot / Symbian / ..
 - Communicating applications are available (email / web-browser / synchronized agenda)
- PDA-like functionality is being integrated in mobile phones

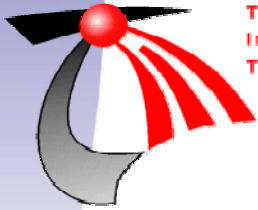

Technological Advances enabling Mobile Internet

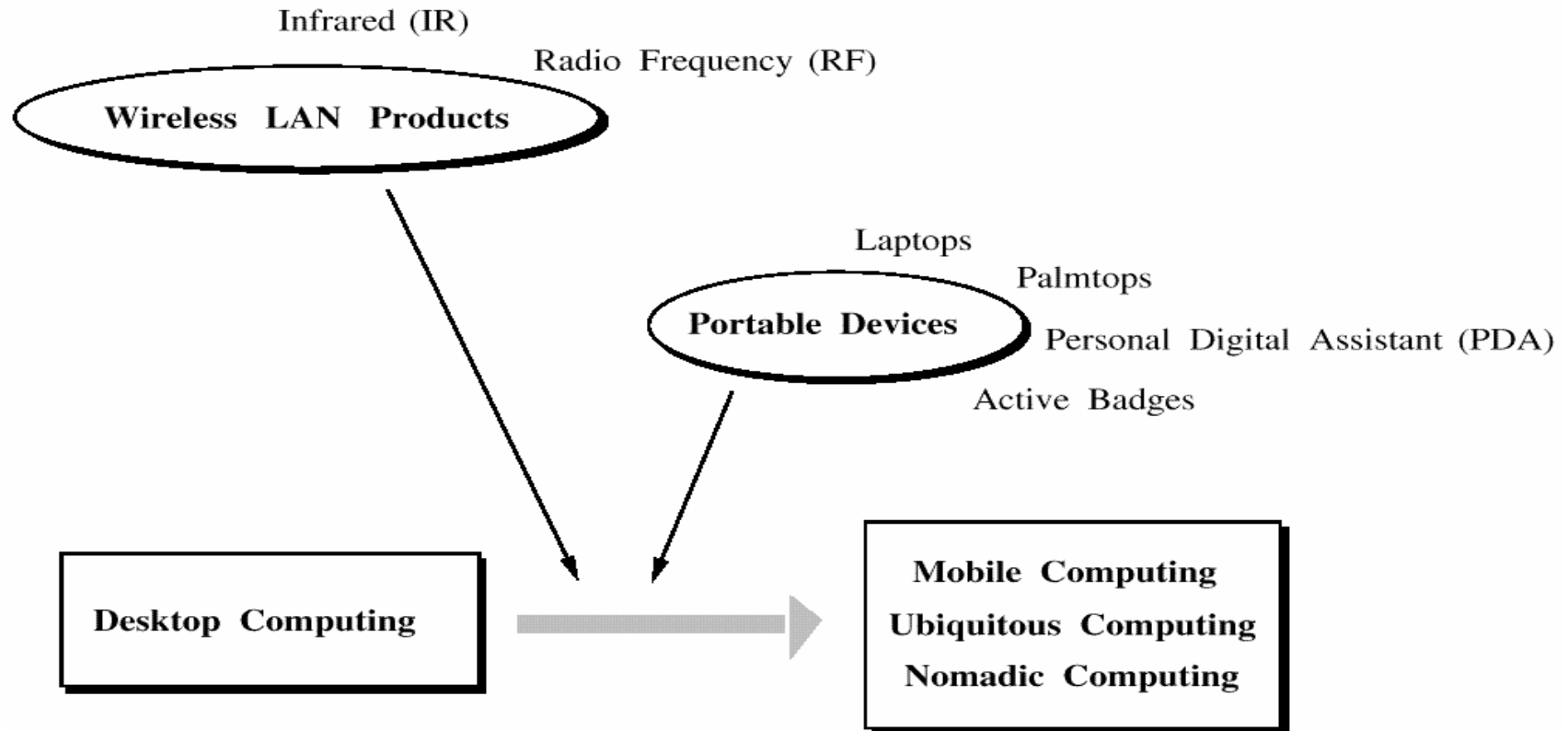

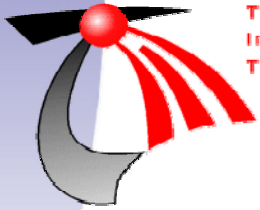

What is the Problem?

- Internet Addressing and Routing
- The way connections are defined in TCP/IP

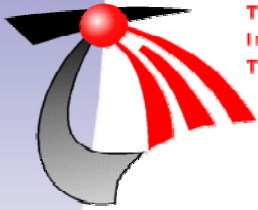

What is the Internet?

- **A large collection of networks**
 - of various types (e.g. Ethernet, ATM, POS, modem, IEEE 802.11),
 - broadcast as well as point-to-point
 - at various speeds (kbit/s - Gbit/s)
- **interconnected by routers**
 - all acting on a common protocol: IP
- **with applications running on the end systems (hosts)**
 - using either TCP or UDP as a transport protocol
 - example applications are WWW (using http), email (smtp / pop3 / imap), news (nntp), telnet, ftp

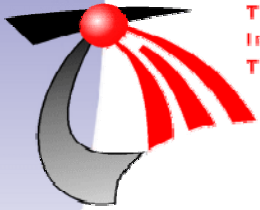

Centre for
Telematics and
Information
Technology



University of Twente
The Netherlands

The Internet

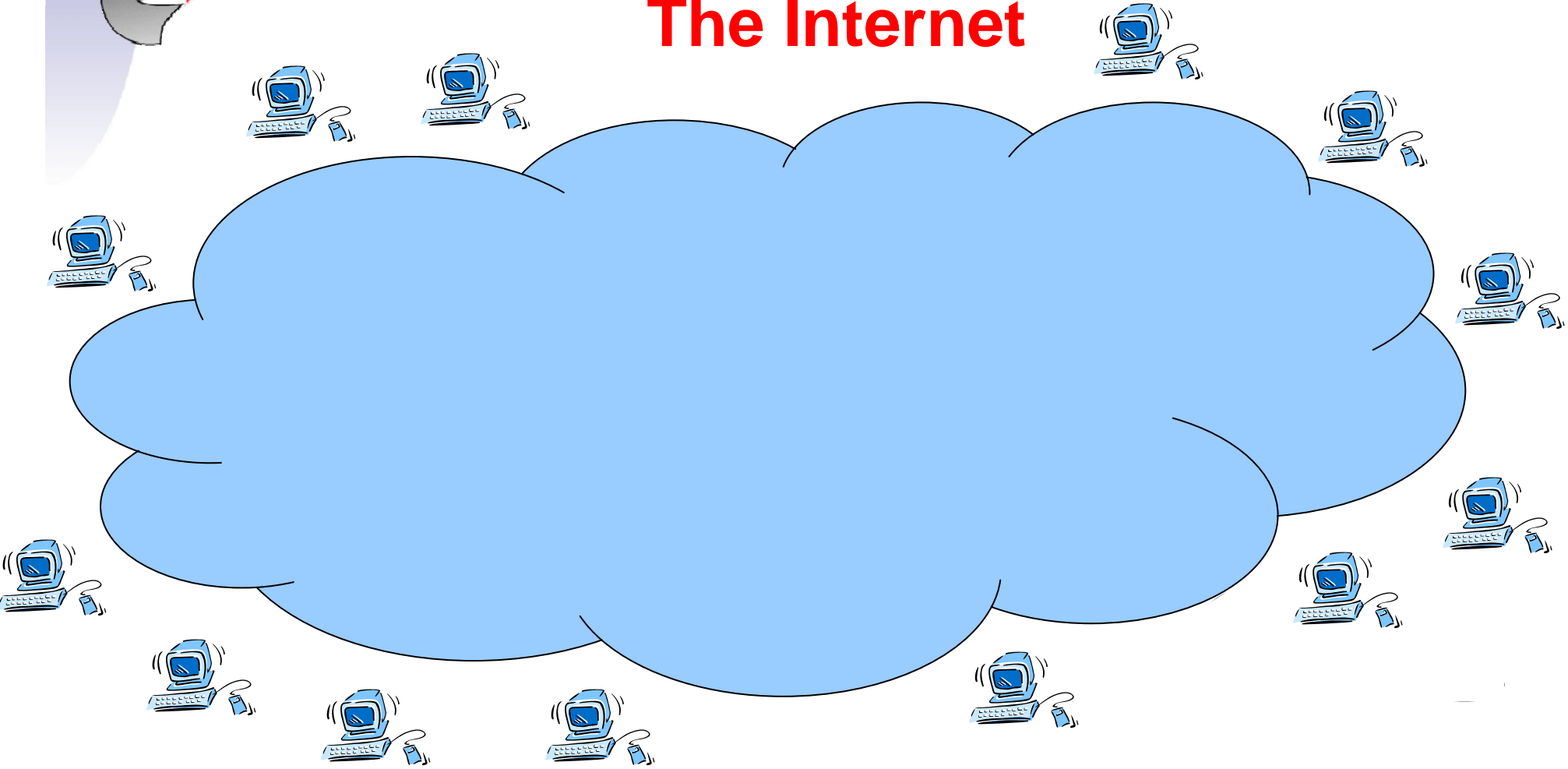

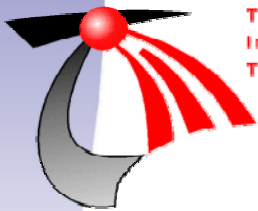

The Internet

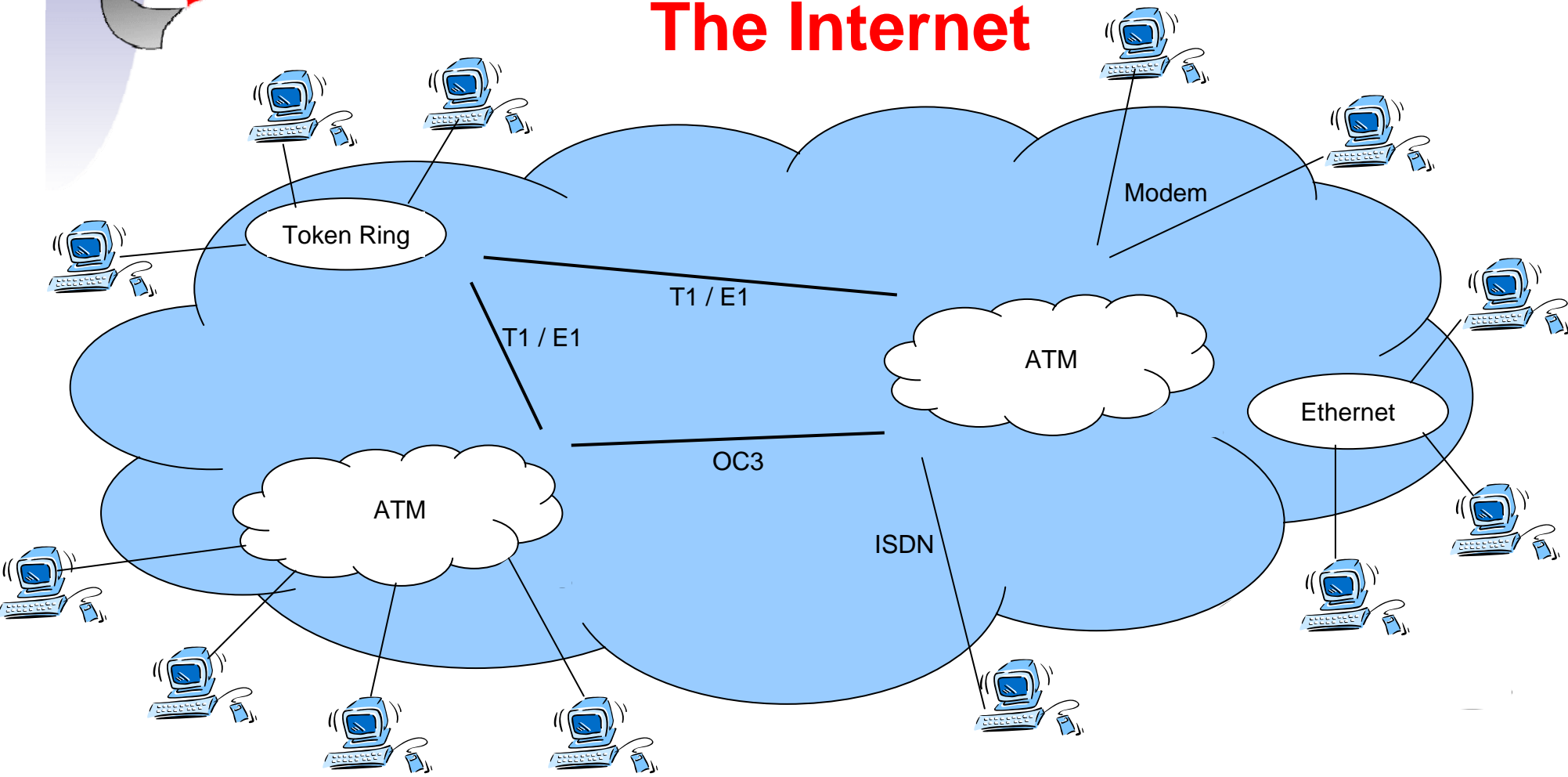

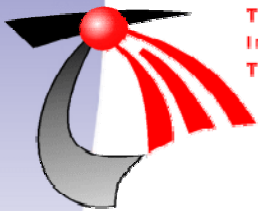

The Internet

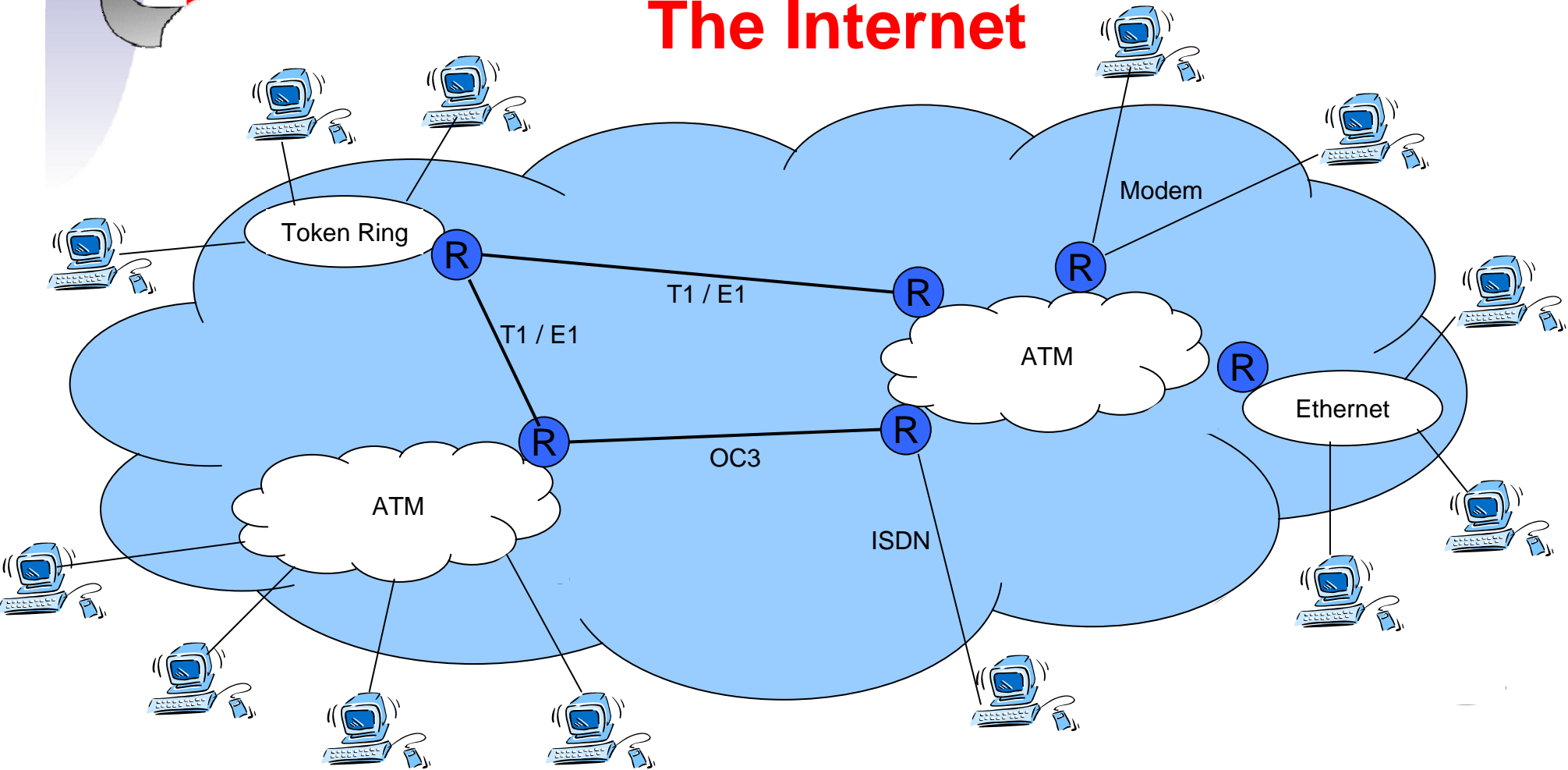

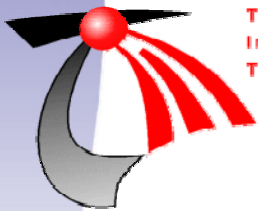

The Internet (2)

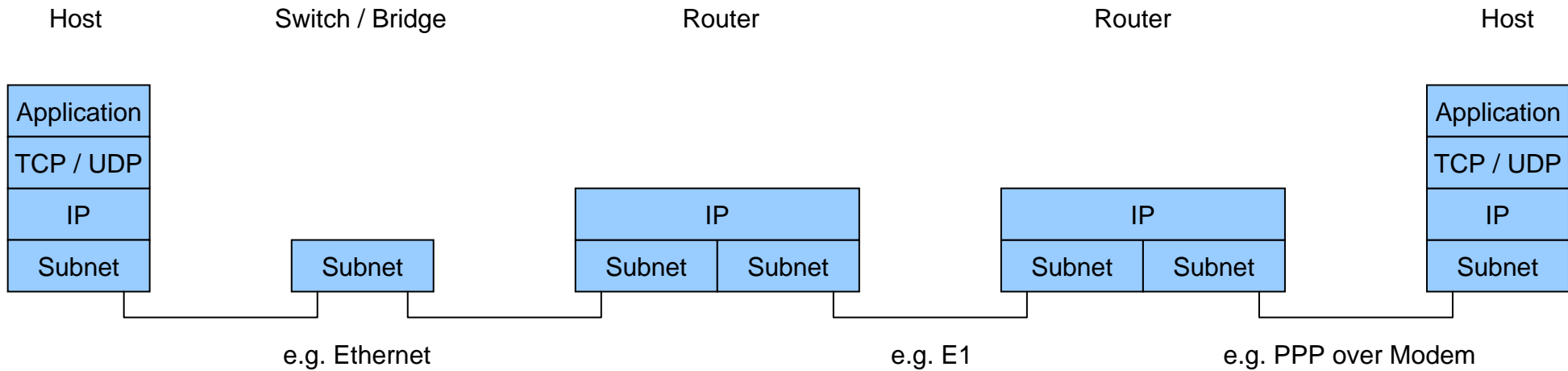

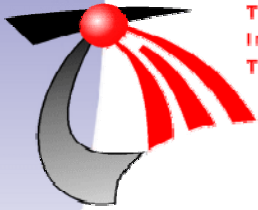

Levels of addresses in the Internet

Domain name (DNS address)

a location independent identifier of a host

utip145.cs.utwente.nl

Internet address (IP address)

the logical location of a host (interface)

I.e., (sub)network id followed by host id

130.89.16.82

Physical address (MAC address)

the hardware address of an interface card

00 a4 24 4a 82 07

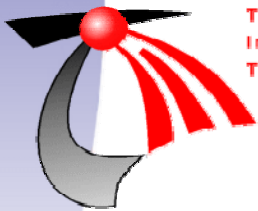

Routing in the Internet

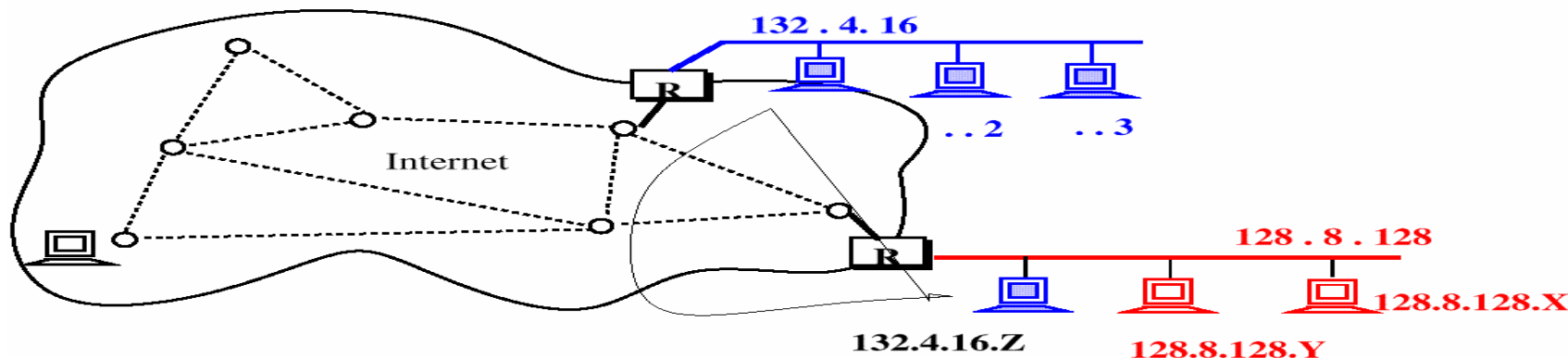

- Packets flow from link (subnetwork) to link via routers
- Packets are routed individually, based on their IP addresses (not on DNS name)
- Routing is based on the (sub)network prefix of the IP address
- » **A mobile host must be assigned a new address when it moves**

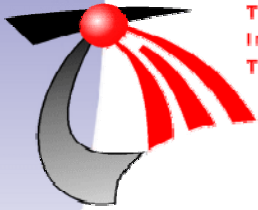

Connections between Internet computers

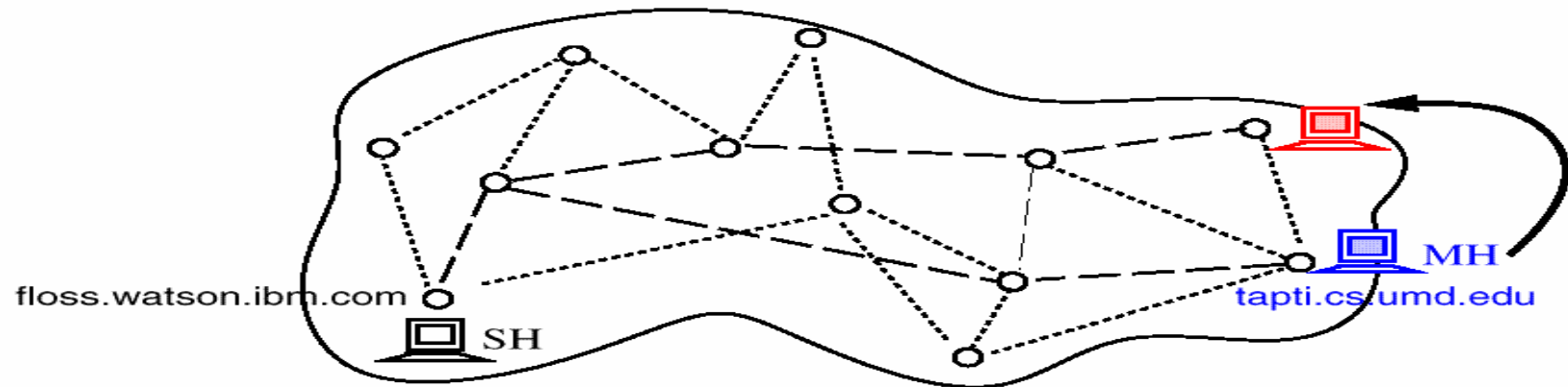

Connection := <129.34.16.43, sh_port #, 128.8.128.45, mh_port #>

- TCP connections are defined by source and destination IP addresses and port numbers
- Change of host address would cause the connection to break
 - » **Host address must be preserved regardless of a hosts location**

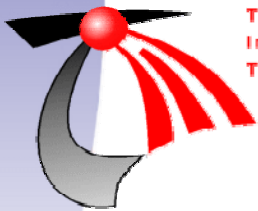

The Mobile IP problem

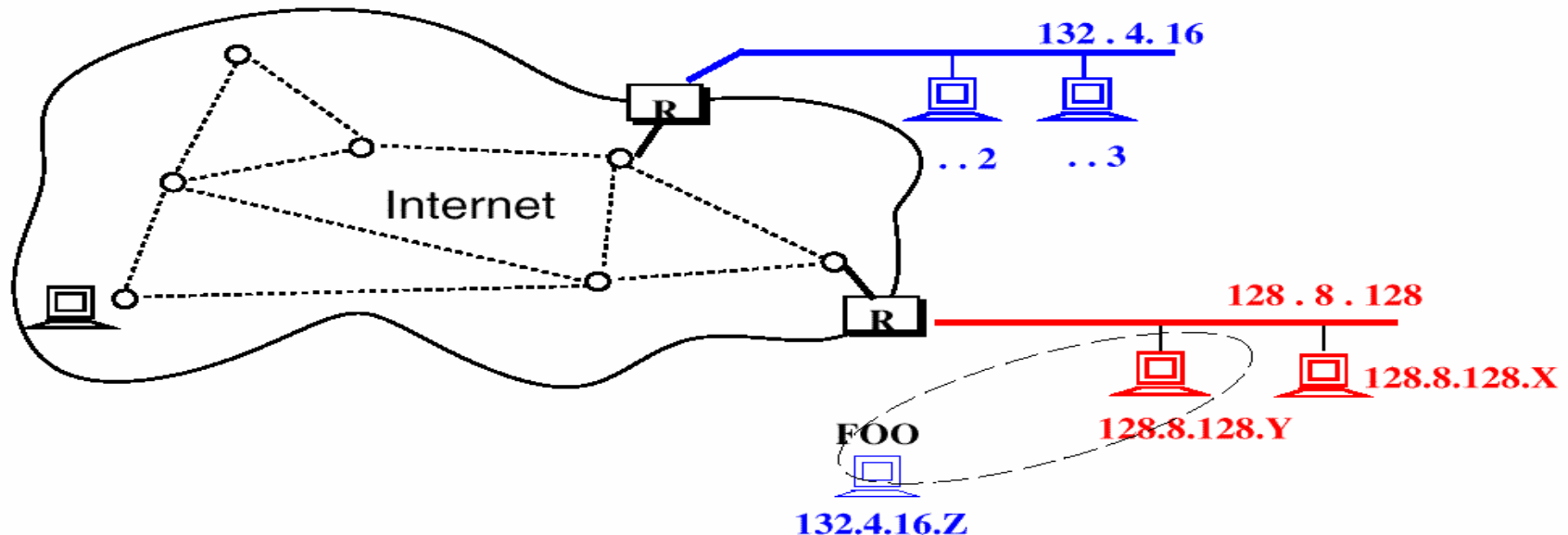

A mobile host must be assigned a new address when it moves

«»

Host address must be preserved regardless of a hosts location



Why Mobility at the Network (IP) Layer?

- Network layer is present in all Internet nodes
- Network layer is responsible for routing packets to the proper location
- Mobility across the entire Internet, even changing physical medium is possible
- Application transparent
- Universal solution for all applications

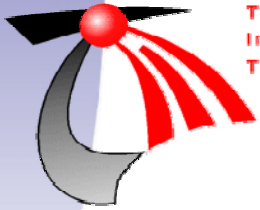

Constraints for Mobile IP

- **Interoperability with the TCP/IP protocol suite**
- **Existing networking applications should run unmodified on mobile hosts**
- **System should provide Internet wide mobility**
- **No modifications to existing routing infrastructure required**
- **No modifications to existing protocols required**
- **Independence of wireless hardware technology**
- **Good scaling properties**

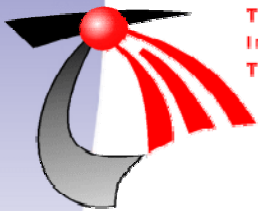

Mobile IP: Basics

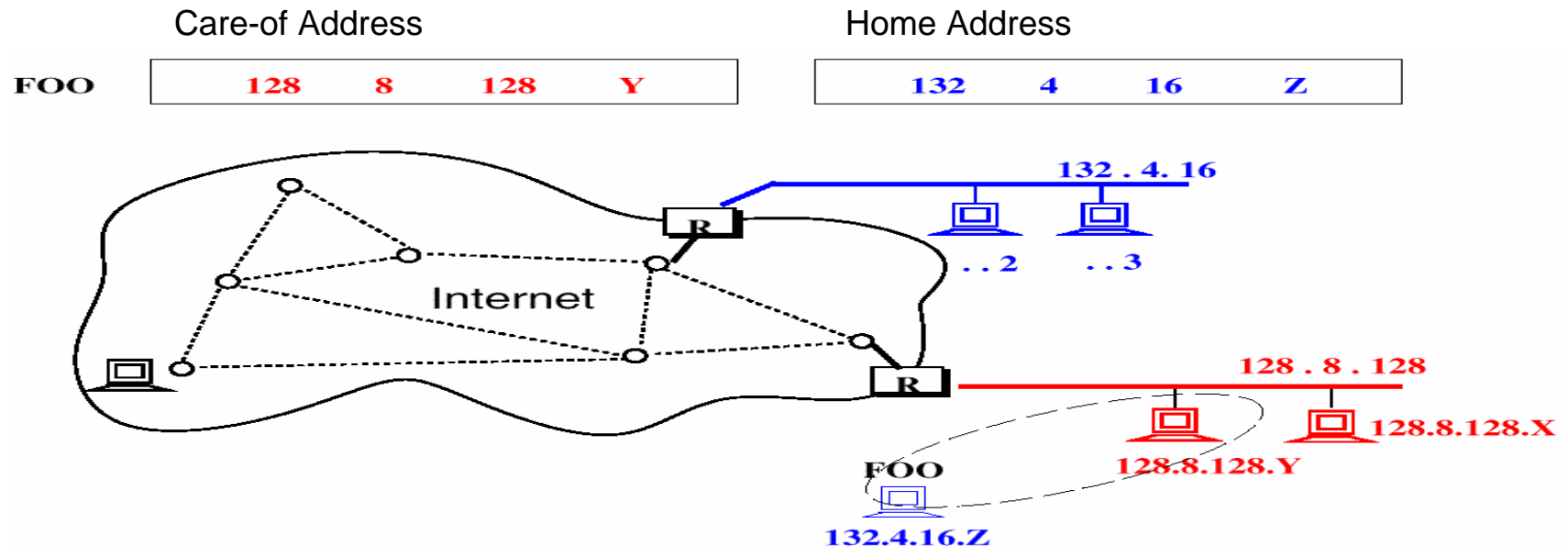

- A mobile host keeps its *home address*, but on a foreign network, it borrows a *care-of address*
- Mobile IP takes care of all issue related to the mapping of the care-of address to the home address

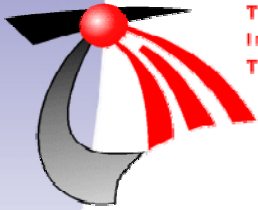

Mobility Model

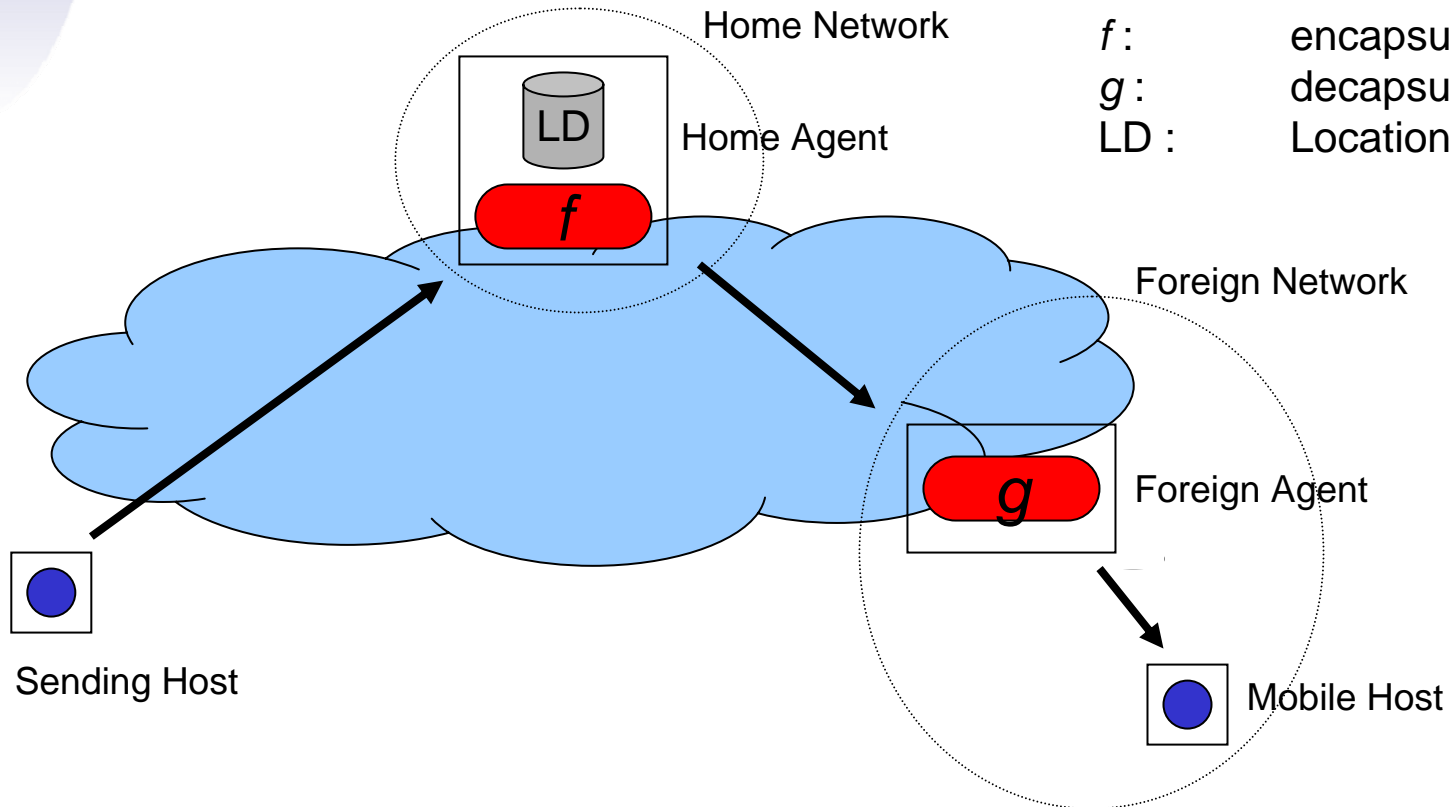

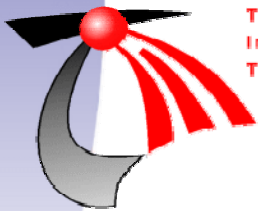

Mobility Model

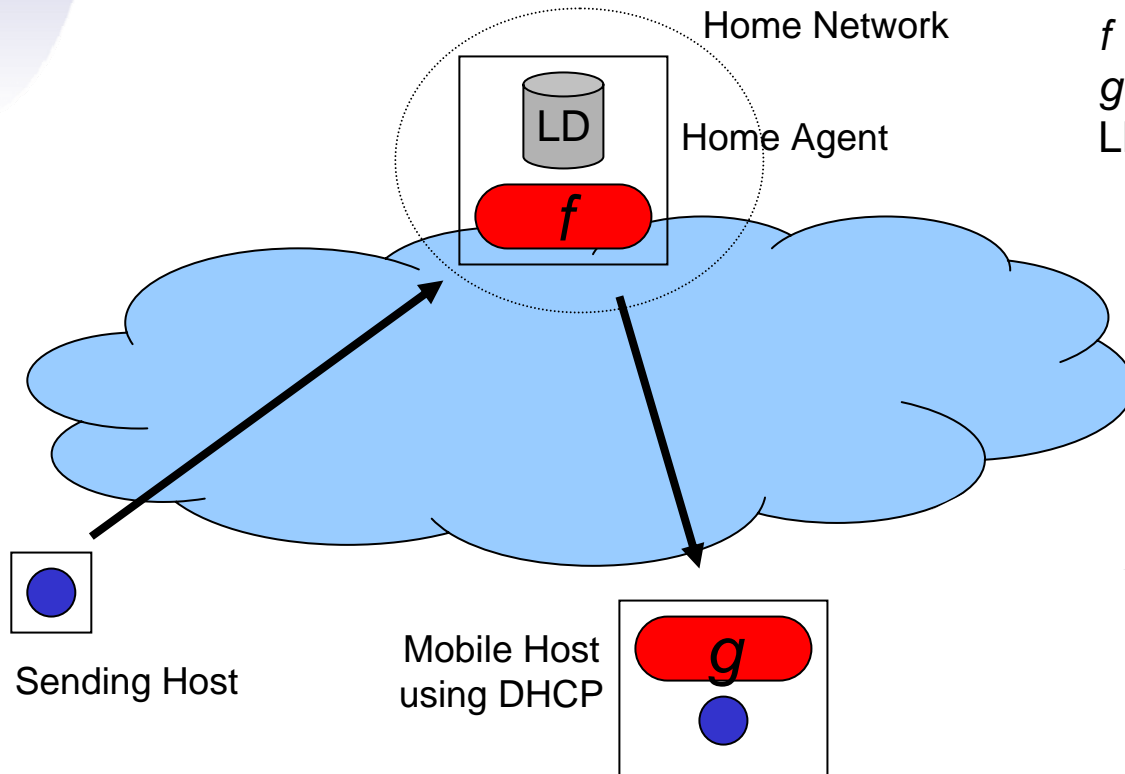

f : encapsulation and re-addressing
 g : decapsulation and forwarding
LD: Location Directory

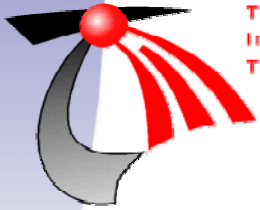

Three Parts of Mobile IP

- **Advertising Care-of Addresses**
- **Registration**
- **Tunneling**

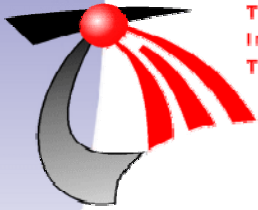

Advertising Care-of Addresses

A *mobility agent* is either a foreign agent or a home agent or both

- **Mobility agents broadcast agent advertisements (ICMP messages)**
- **Mobile hosts can solicit for an advertisement**
- **Advertisements contain:**
 - **mobility agent address**
 - **care-of addresses**
 - **lifetime**
 - **flags**

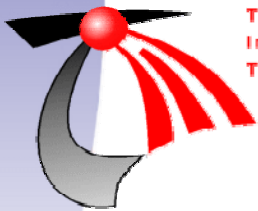

Registration

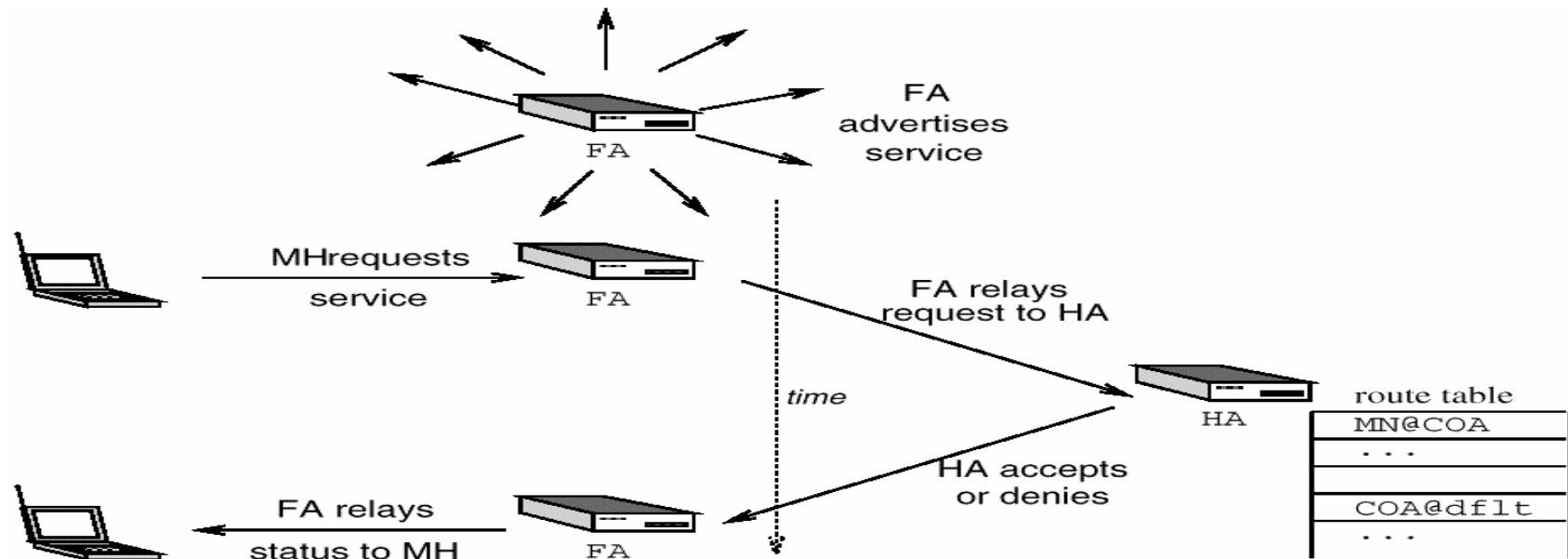

- **binding** : (home address, care-of address, lifetime)
- registration is needed to update the binding
- registration requires authentication
- registration uses UDP

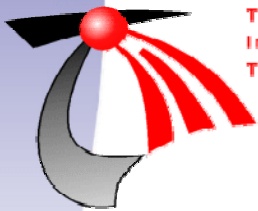

Tunneling

- Home agent tunnels (encapsulates) packets to care-of address
- Tunnel source is the home agent's address
- Tunnel destination is the care-of address
- IP within IP (other ways exist):

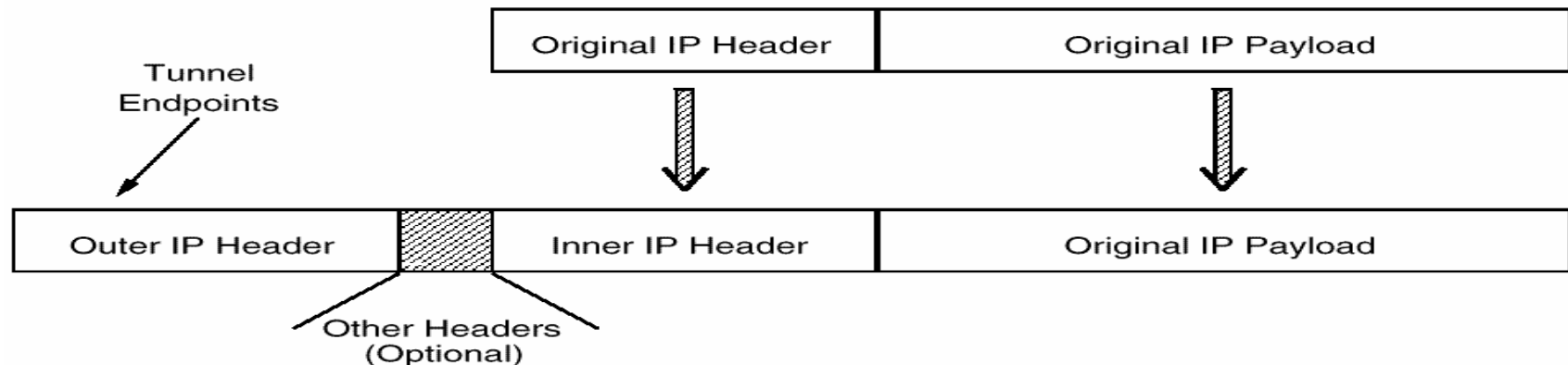

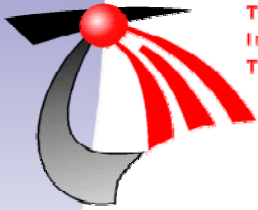

Types of Home Networks

- Home agent as a separate system on the home network
- Home agent integrated with a router on the home network
- A virtual home network

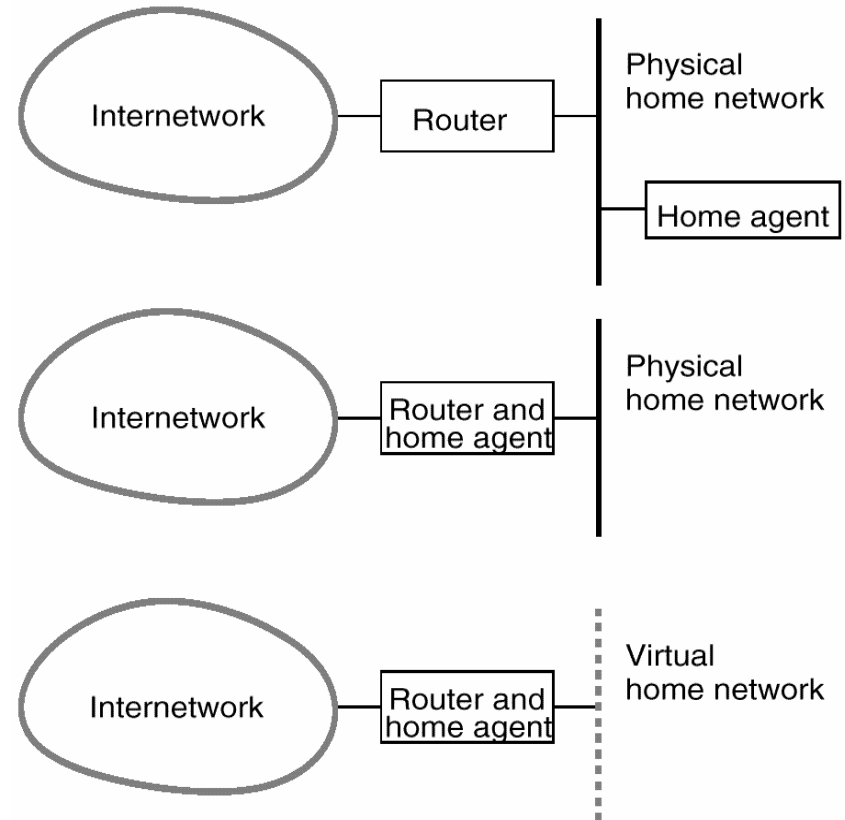

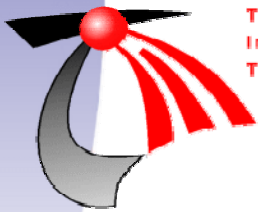

ARP

- **ARP: Address Resolution Protocol**
- **Used to find (Physical) MAC address if IP address is known**
- **ARP Request is a broadcast**
- **ARP Reply is returned to requester**

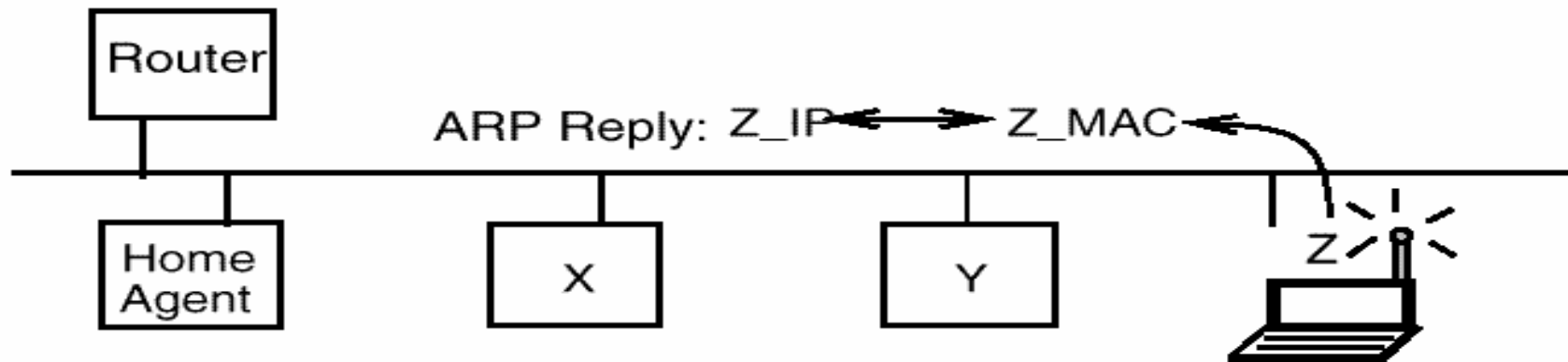

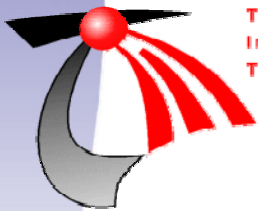

Proxy ARP and Gratuitous ARP

- **Proxy ARP: Home Agent Replies to ARP requests for the Mobile Host**
- **Gratuitous ARP: The Home Agent or Mobile Host Broadcast a not requested ARP after a change has occurred (Mobile Host has roamed in or out)**

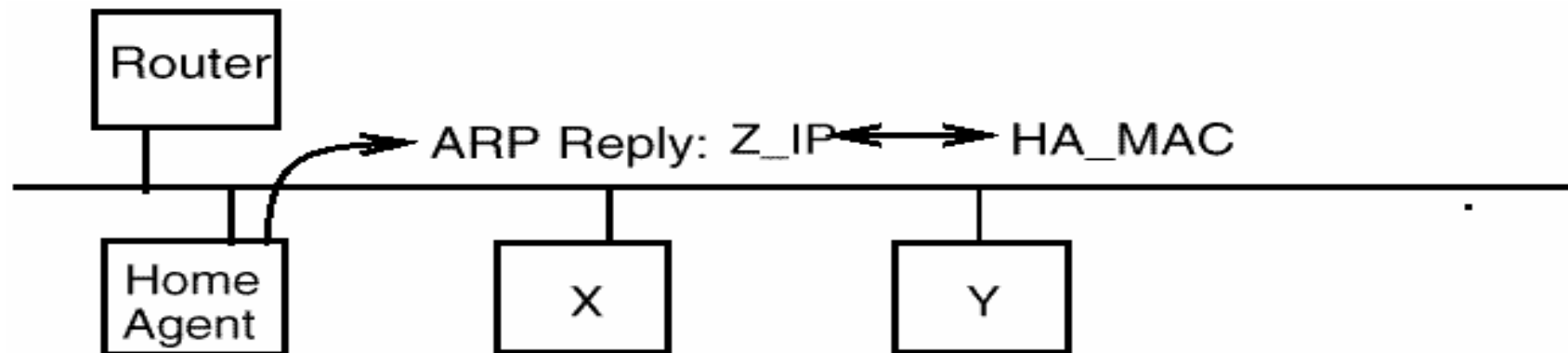

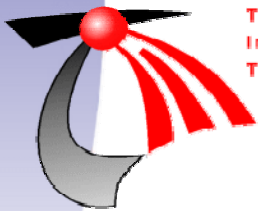

Triangle Routing

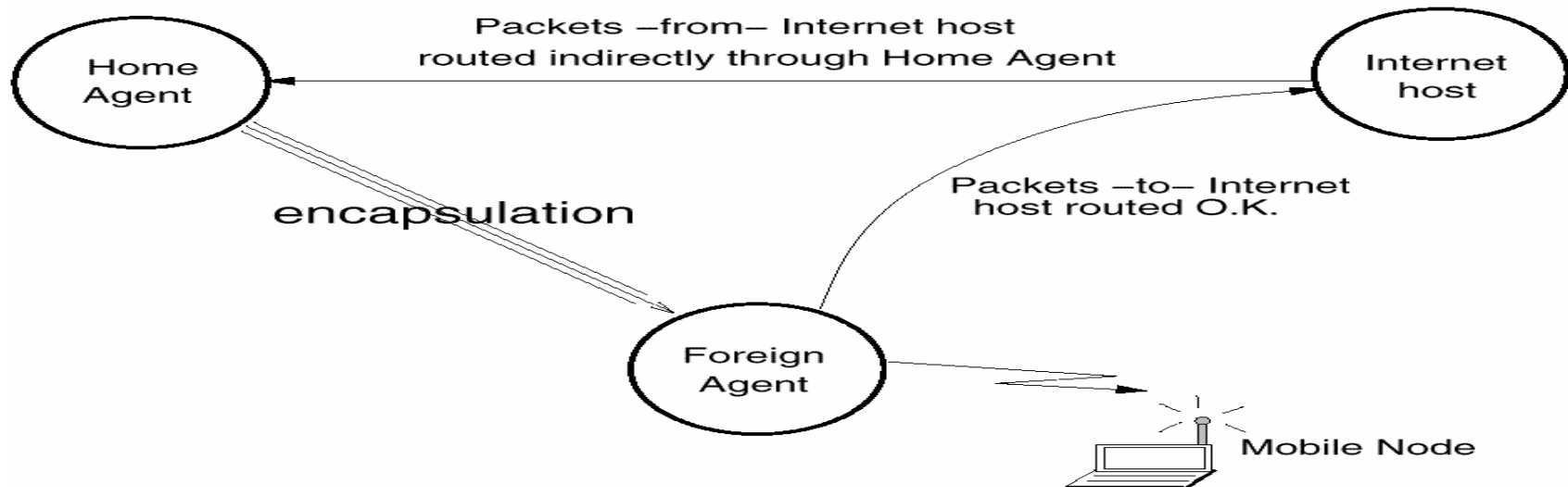

Triangle routing is undesirable because

- home agent is the bottleneck
- more network load, and sensitivity to network partition

In case of reverse tunneling, the situation is even worse

⇒ Route optimization: Get binding to the correspondent host

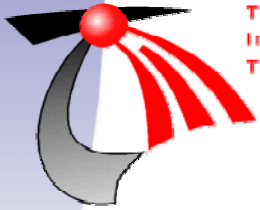

(Smooth) Handoff

- **Mobile host moves along subnetworks, from FA to FA.**
- **Packets already in flight to old FA are lost after handoff to new FA**
- **Route optimization allows old FA to forward packets to new care-of address**

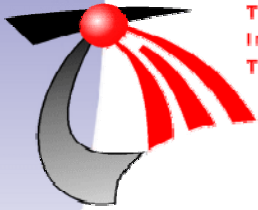

Route Optimization (1)

Get binding to relevant correspondent hosts for optimal routing:

- **binding warning (mobility agent → correspondent host)**
- **binding request (correspondent host → home agent)**
- **binding update (home agent → correspondent host)**
- **binding acknowledge (optional)**

security association between correspondent host and home agent is needed for authentication

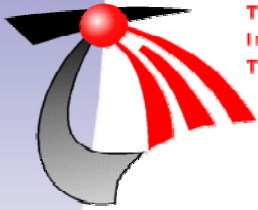

Route Optimization (2)

Get binding to old Foreign Agent for smooth handoff:

- previous foreign agent notification extension (mobile host → new FA)
- binding update (new FA → old FA)
- binding acknowledge (old FA → mobile host)

mobile host and foreign agent need to exchange registration key for authentication

last resort: special tunnel (old FA tunnels packet back to the HA)

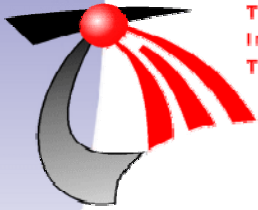

Mobility for IPv6

- **All nodes can handle bindings**
 - No triangular routing
- **Binding updates are carried in Destination Option**
 - Small overhead for distributing bindings
- **Mobile host can create its own care-of address using link-local address and automatic address configuration (combine advertised subnet prefix with own hardware address)**
 - No need for foreign agent

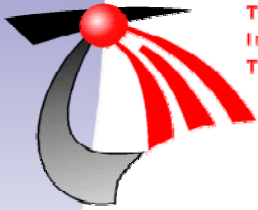

Conclusions

- **Mobile IP offers migration towards global mobility in the Internet**
- **Mobile IP is not optimal (e.g., triangular routing, seamless handover), but it is being improved**
- **Mobility in IPv6 is easier, because all nodes have suitable functionality, and no foreign agent is required**
- **Improvements to be made:**
 - **Support for real-time applications**
 - » **seamless hand-over**
 - » **resource reservation**
 - **Operation in secure environments**

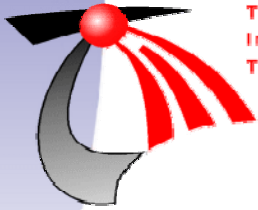

Status of Mobile IP

Internet Proposed Standard Protocols:

- **RFC2002: IP Mobility Support, October 1996**
- **RFC2005: Applicability Statement for IP Mobility Support, October 1996**
- **RFC2006: The Definitions of Managed Objects for IP Mobility Support using SMIv2, October 1996**
- **RFC2290: Mobile-IPv4 Configuration Option for PPP IPCP, February 1998**
- **RFC2344: Reverse Tunneling for Mobile IP, May 1998**

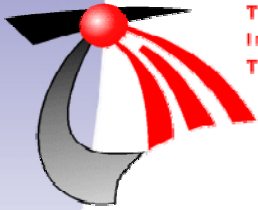

Further Reading

- **This Presentation:**
<http://www.ctit.utwente.nl/~heijenk/Eunice99>
- **“Mobile Networking Through Mobile IP”
Tutorial by Charlie Perkins:**
<http://computer.org/internet/v2n1/perkins.htm>
- **“Mobile IP, Design Principles and Practices”
Book by Charles E. Perkins**
- **“Mobile IP, The Internet Unplugged”
Book by James D. Solomon**
- **IETF Mobile IP WG:**
<http://www.ietf.org/html.charters/mobileip-charter.html>