

Free energy of formation of stabilized Bi_2O_3 (fcc) from e.m.f. measurements

M. J. VERKERK, A. J. BURGGRAAF

Twente University of Technology, Department of Inorganic Materials Science, PO Box 217, 7500 AE Enschede, The Netherlands

Received 23 October 1979

Using cells with calcia stabilized zirconia as the solid electrolyte, the standard free energy of formation of stabilized Bi_2O_3 (fcc) was determined in the temperature range 750–950 K. The stability against reduction of stabilized Bi_2O_3 (fcc) is not increased with respect to pure $\delta\text{-Bi}_2\text{O}_3$ (fcc). The corrosion of the calcia stabilized zirconia tube caused by Bi_2O_3 which took place along the grain boundaries, was investigated.

1. Introduction

In recent years much work has been directed to the development of materials which predominantly exhibit oxygen ion conduction at low temperatures. Bi_2O_3 was found to be a promising material for this purpose.

A highly ionic, conductive phase $\delta\text{-Bi}_2\text{O}_3$ (face centered cubic, or fcc) exists from 1003 K up to the melting point at 1097 K. In this range the electrical conductivity is about 100 S m^{-1} . On cooling this highly conductive phase is stable down to about 918 K [1, 2].

The highly ionic conductive phase (fcc) can be stabilized to room temperature by substituting Bi_2O_3 with Y_2O_3 , Gd_2O_3 , WO_3 , Nb_2O_5 , Ta_2O_5 [3], Er_2O_3 [4] and Dy_2O_3 [5]. The oxygen ionic transference number was found to be equal to one in substituted Bi_2O_3 fcc phases [3–5]. The conductivity of stabilized bismuth sesquioxides is one decade or more higher than that of stabilized zirconias at the same temperature.

However, at higher temperatures these stabilized bismuth sesquioxides show a tendency to be reduced under low oxygen pressures, $P_{\text{O}_2} = 10^{-12} \text{ atm}$ at 900 K [6, 7]. Therefore application will be limited to devices such as oxygen pumps [8] and oxygen gauges [5].

Thermodynamic data on $\delta\text{-Bi}_2\text{O}_3$ have been obtained by electrochemical measurements. Some data by various workers are shown in Table 1 and

it can be seen that there is good agreement between these values in view of the standard deviation.

As solid electrolytes CSZ (calcia stabilized zirconia) [9, 10] and $\delta\text{-Bi}_2\text{O}_3$ [11] have been used. In the former cases [9, 10] no attention was paid by the authors to problems which can arise by reaction between the Bi_2O_3 and the CSZ. The high temperature and the molten phases of Bi_2O_3 are very corrosive and attack ZrO_2 [1]. Pouillard *et al.* [12] suggested that the corrosion of the CSZ tube by liquid Bi_2O_3 was a possible cause of inconsistent results at high temperatures for the cell:

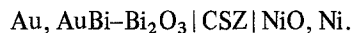

Therefore chemical attack on the zirconia-based electrolyte will be a point of concern in the current investigations.

Some measurements on stabilized bismuth sesquioxide were performed by Takahashi *et al.* [7]. These authors measured the e.m.f. as a function of temperature of the cell:

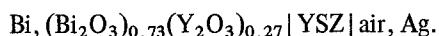

They find a good agreement between their values and those for $\delta\text{-Bi}_2\text{O}_3$ measured by Chatterji and Smith [9]. This result implies that the stability of stabilized Bi_2O_3 against reduction is no better than that of $\delta\text{-Bi}_2\text{O}_3$. However, addition of a relatively large amount of substituent ($x \geq 0.50$) may prevent reduction as pointed out for quite different systems.

Table 1. Thermodynamic data on the formation of δ - Bi_2O_3 and Bi_2O_3 stabilized by Er_2O_3 and Dy_2O_3 (fcc structure) from electrochemical measurements

Reference	Cell system	$\Delta G^\circ = a + bT$ (kJ mol ⁻¹)		
		$-a$ (kJ mol ⁻¹)	$b \times 10^3$ (kJ mol ⁻¹ T ⁻¹)	Validity range (K)
9	W, Bi-Bi ₂ O ₃ CSZ Air, Pt	561 ± 2	265 ± 9	795–1095
10	Bi, Bi ₂ O ₃ CSZ FeO, Fe	558	272	991–1095
11	W, Bi Bi ₂ O ₃ P ₂ O ₅ , Pt	564 ± 5	268 ± 5	949–1076
this work	W, Bi-(Bi ₂ O ₃) _{0.50} (Dy ₂ O ₃) _{0.50} CSZ FeO, Fe	561 ± 5	271 ± 10	750– 950
this work	W, Bi-(Bi ₂ O ₃) _{0.545} (Er ₂ O ₃) _{0.455} CSZ FeO, Fe	559 ± 7	268 ± 13	750– 950

Takahashi *et al.* [7, 19, 20] report that the stability against reduction of $[\text{CeO}_2]_{1-x}[\text{LaO}_{1.5}]_x$ with $x = 0.20$ (fcc) may be increased at higher values of x , e.g. $x = 0.50$ (fcc) or by addition of thoria, e.g.

$[\text{CeO}_2]_{0.3}[\text{LaO}_{1.5}]_{0.3}[\text{ThO}_2]_{0.4}$ (fcc)

Park and Logothetis [13] report an enhanced stability against reduction for $\text{Co}_{1-x}\text{Mg}_x\text{O}$ (monoxide) if x increases from $x = 0.1$ to $x \geq 0.5$.

For practical applications it is very important to know at which oxygen partial pressure stabilized bismuth sesquioxides are reduced, but data about this subject are very scarce. From these points of view the authors have investigated the following cells:

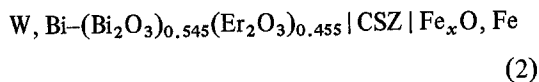
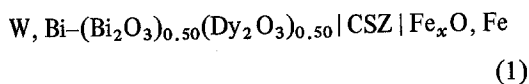

A detailed description of the systems Bi_2O_3 - Dy_2O_3 and Bi_2O_3 - Er_2O_3 is given elsewhere [5, 4].

In case these stabilized bismuth sesquioxides behave as an ideal solution, we should expect at least a difference from pure δ - Bi_2O_3 caused by the entropy term

$$RT \ln [\text{Bi}_2\text{O}_3] = 5.8 \times 10^{-3} T \text{ kJ mol}^{-1}$$

$$\text{for } [\text{Bi}_2\text{O}_3] = \frac{1}{2}.$$

The standard deviation of the thermodynamic values is however too large for this effect to be measured (see Table 1).

2. Experimental details

The open-circuit e.m.f. of Cells 1 and 2 was measured as a function of temperature using the cell assembly given in Fig. 1. The cell temperature was constant within 1 K.

The 12 mol% CaO-stabilized ZrO_2 tubes were purchased from Degussa. The tubes were 400 mm long, inner diameter 10 mm and outer diameter 15 mm. The main impurities were: 0.4 wt% SiO_2 , 1.2 wt% Al_2O_3 and 0.1 wt% Fe_2O_3 . Fe (99.5%) and Fe_2O_3 (99.0%) were purchased from Merck and Bi (99.96%) from Baker.

The preparation and the purity of the stabilized Bi_2O_3 is described in [4, 5].

The Bi-stabilized Bi_2O_3 electrode was prepared by mixing the metal powder with the oxide powder in about a 5 : 1 weight ratio. The Fe- Fe_xO electrode [10, 21] was prepared by mixing the Fe powder with Fe_2O_3 powder in a 5 : 1 weight ratio. Before putting the Bi-stabilized Bi_2O_3 electrode in the CSZ tube, the Fe- Fe_2O_3 mixture was heated in the cell to 1020 K to establish equilibrium and then slowly cooled down. The Fe- Fe_xO electrode shrinks around the CSZ tube during this procedure.

Before starting a new measurement the quartz tube and the CSZ tube were thoroughly rinsed with purified N_2 .

A tungsten lead wire was used for the Bi-stabilized Bi_2O_3 electrode, because tungsten does not alloy with liquid bismuth [9, 14].

The open-circuit e.m.f. was measured with a HP3465A multimeter, having an accuracy of 0.1 mV. The input impedance of the multimeter was in this range $> 10^{10} \Omega$. On reaching the desired temperature the e.m.f. assumed a stable

value within 20 minutes. In the temperature range of 750–900 K the e.m.f. remained constant within ± 1 mV for 24 hours. Above 900 K the e.m.f. signal was not constant for long periods possibly caused by reaction between stabilized Bi_2O_3 and the CSZ tube, see below.

The reversibility of the measured e.m.f. was checked by shorting the cell for some seconds and allowing the e.m.f. to return to a stable value. At low temperatures (< 850 K) the cell returned to its original value within 2–3 min, at higher temperatures within a minute. Because dissimilar leads were used the thermal e.m.f. of W–Pt was measured in a cell according to Chatterji and Smith [9] and the measured e.m.f. was corrected for it.

Prior to the experiments the reaction between Bi_2O_3 and CSZ was studied. In the cell assembly of Fig. 1 a measurement was performed with a Bi– Bi_2O_3 electrode up to 1160 K (the melting point of Bi_2O_3 is 1097 K) and held for one hour at this temperature. The cell was cooled down to about 800 K and again the e.m.f. was measured as a function of temperature on heating. Up to 950 K there was good agreement with the values of the first run; above 950 K a very unstable e.m.f. was measured and deviations appeared.

After these runs the lower part of the CSZ tube was polished and investigated with a SEM (scanning electron microscope, type JEOL JSMU3 with an EDAX unit for chemical analysis).

The microstructure of a part of the CSZ tube is shown in Fig. 2. Between the dark CSZ grains a light-coloured second phase can be seen.

A chemical analysis was performed over the straight line in the figure; the variation of the Bi concentration along this line is given by the erratically-formed line. It appears that a high Bi concentration is present in the second phase. A spot analysis showed that no other elements such as Zr(IV) or Ca(II) could be detected in this second phase[†]. X-ray diffraction on the powdered CSZ tube showed that Bi_2O_3 had a γ -structure (body centered cubic, or bcc).

Bi_2O_3 easily forms a bcc structure if it is contaminated by Al, Si, Fe, Zr, Ce, Tl and Pb as reported by Aurivillius and Sillén [15] and other authors [16, 17]. This b.c.c. structure may be

[†] The detection limit of Zr in a Bi_2O_3 -rich phase is about 3%.

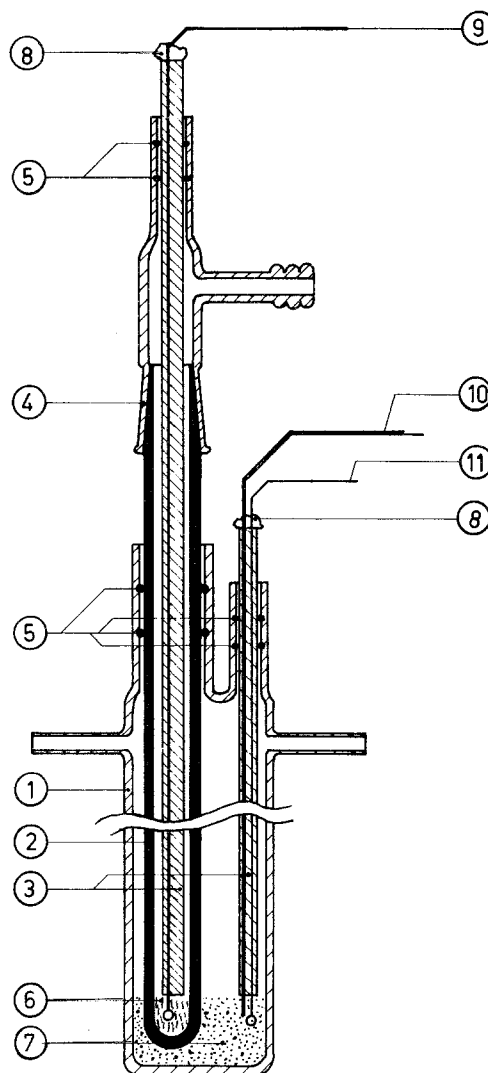

Fig. 1. Cell assembly for the e.m.f. measurements. 1, Quartz tube; 2, ZrO_2 -CaO tube; 3, alumina tube; 4, B14 ground glass joint; 5, Viton O-rings; 6, Bi, $(\text{Bi}_2\text{O}_3)_{1-x}(\text{M}_2\text{O}_3)_x$; 7, Fe, FeO; 8, epoxy; 9, tungsten electrode; 10, thermocouple; 11, platinum electrode.

formed under the influence of the impurities of the CSZ-tube or by ZrO_2 .

It can be concluded that Bi_2O_3 reacts with CSZ at high temperatures and this may be the cause for unstable e.m.f. signals. For this reason our measurements were performed in the 750–950 K range. After the measurements in this temperature range the CSZ-tube was investigated using the SEM but no Bi_2O_3 could be detected.

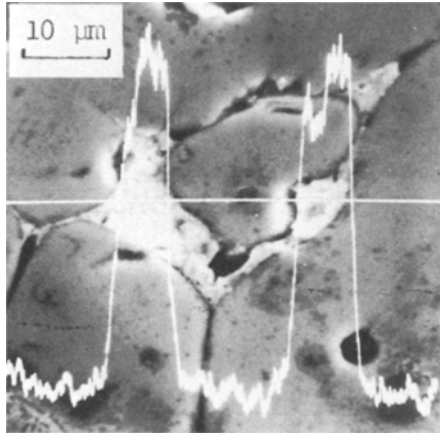
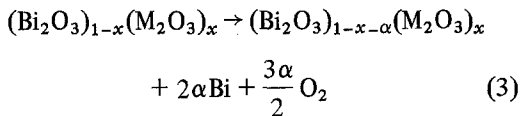

Fig. 2. Microstructure of a ZrO_2 -CaO tube exposed to Bi and Bi_2O_3 at high temperatures (see text).

3. Results and discussion

According to Takahashi [7] the virtual reaction at the Bi-stabilized Bi_2O_3 electrode is:



this can be written:

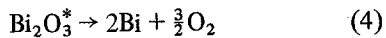

(the asterisk denotes a stabilized Bi_2O_3 , i.e. $(Bi_2O_3)_{1-x}(M_2O_3)_x$ with a fcc structure).

The open-circuit e.m.f. is related to the oxygen partial pressures at the two electrodes by the expression:

$$E = \frac{RT}{4F} \ln (P'_{O_2}/P''_{O_2}); \quad P'_{O_2} > P''_{O_2} \quad (5)$$

where P'_{O_2} is the oxygen partial pressure at the Bi-stabilized Bi_2O_3 electrode and P''_{O_2} the oxygen pressure at the Fe- Fe_xO electrode. The oxygen partial pressures of the electrodes are related to the free energy of formation of the oxides, so we obtain the following free energy-e.m.f. relation:

$$\Delta G^0(Bi_2O_3^*) = 3\Delta G^0(Fe_xO) + 6FE \quad (6)$$

Fig. 3 shows the thermal e.m.f. of the W-Pt thermocouple (reference junction at 273 K) as a function of temperature and in the temperature range 825-1000 K a linear relation is observed.

Three independent measurements (e.m.f. versus T) were performed on the Cells 1 and 2. E.m.f. measurements of Cell 1 as a function of temperature are given in Fig. 4. This figure is representative of all the measurements performed on Cells 1 and 2. The e.m.f.-temperature relationships, corrected for thermal e.m.f., are obtained by a least square calculation; the results of three measurements are

$$Cell 1: E = (399 \pm 4) + (0.126 \pm 0.005) T \quad (mV) \quad (7)$$

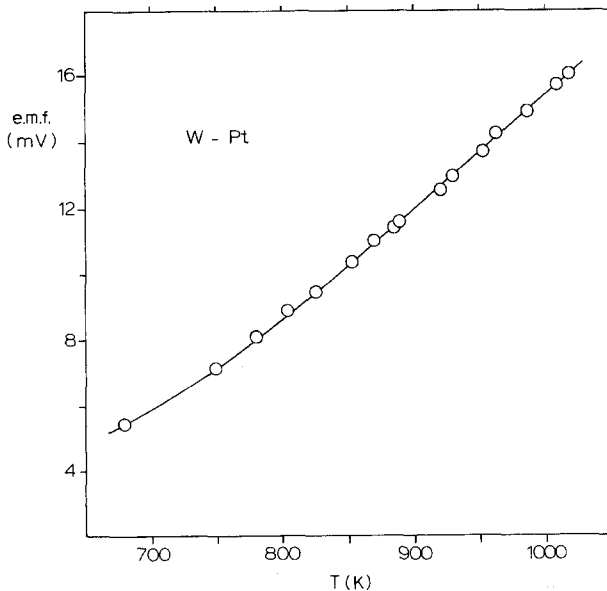

Fig. 3. Thermal e.m.f. of W-Pt couple as a function of temperature.

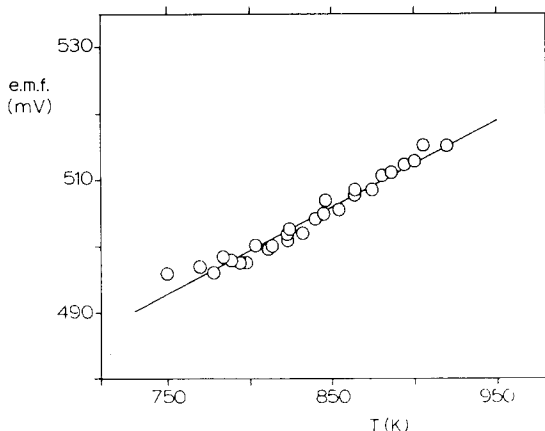

Fig. 4. E.m.f. of Cell 1 as a function of temperature.

$$\text{Cell 2: } E = (402 \pm 5) + (0.122 \pm 0.06)T \quad (\text{mV}) \quad (8)$$

The deviation is given in the 90% reliability interval. The values of $\Delta G^0(\text{Bi}_2\text{O}_3^*)$ are calculated with Equation 6 and are given in Table 1. Use has been made of the value of

$$\begin{aligned} \Delta G^0(\text{Fe}_x\text{O}) &= -263.93 \\ &+ 65.93 \times 10^{-3}T \quad (\text{kJ mol}^{-1}) \end{aligned}$$

taken from the work of Tretjakow and Schmalzried [18].

There is a good agreement between the thermodynamic values of stabilized- Bi_2O_3 (fcc) and pure $\delta\text{-Bi}_2\text{O}_3$ (fcc), taking into account the standard deviation in the experimental values. Contrary to the systems CoO [13] and CeO_2 [7, 19, 20] where the stability against reduction can be increased by substituting ($x \approx 0.50$), this is not the case with stabilized Bi_2O_3 , which behaves 'ideally'.

Therefore we can conclude that no increase in the stability range of $\delta\text{-Bi}_2\text{O}_3$ can be achieved by stabilization of $\delta\text{-Bi}_2\text{O}_3$ with a large amount of lanthanide.

4. Conclusion

For practical applications it is very important to know at which oxygen pressures stabilized bismuth sesquioxide is reduced. The thermodynamic data were measured for:

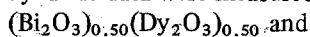

$(\text{Bi}_2\text{O}_3)_{0.545}(\text{Er}_2\text{O}_3)_{0.455}$. We can conclude that the stability range against reduction of stabilized Bi_2O_3 (fcc) is not increased with respect to pure $\delta\text{-Bi}_2\text{O}_3$ (fcc) so applications will be limited to devices such as oxygen pumps and oxygen gauges.

At 900 K the equilibrium oxygen pressure of a stabilized Bi_2O_3 is 10^{-12} atm.

Acknowledgements

The authors would like to express their appreciation to Mr M. A. de Jongh for performing the SEM and EDAX experiments. Financial assistance from Philips NV (Elcoma) is gratefully acknowledged.

References

- [1] H. A. Harwig and A. G. Gerards, *Thermo Chimica Acta* **28** (1979) 121.
- [2] *Idem*, *J. Solid State Chem.* **26** (1978) 265.
- [3] T. Takahashi and H. Iwahara, *Mater. Res. Bull.* **13** (1978) 1447.
- [4] M. J. Verkerk, K. Keizer and A. J. Burggraaf, *J. Appl. Electrochem.* **10** (1980) 81.
- [5] M. J. Verkerk *et al.*, to be published.
- [6] T. Takahashi, H. Iwahara and Y. Nagai, *J. Appl. Electrochem.* **2** (1972) 97.
- [7] *Idem*, *ibid* **7** (1977) 299.
- [8] K. W. Browall, *Electrochem. Soc. Spring Meeting* (1978) abstract no 467.
- [9] D. Chatterji and J. V. Smith, *J. Electrochem. Soc.* **120** (1973) 889.
- [10] G. M. Mehrotra, M. G. Froberg and M. L. Kapoor, *Z. Phys. Chem. N.F.* **99** (1976) 304.
- [11] H. T. Cahen, M. J. Verkerk and G. H. J. Broers, *Electrochim. Acta* **23** (1978) 885.
- [12] G. Pouillard, M. Trinel-Dufour, Z. Derriche and P. Perrot, *Rev. Chim. Min.* **16** (1979) 30.
- [13] K. Park and E. M. Logothetis, *J. Electrochem. Soc.* **124** (1977) 1443.
- [14] Gmelins Handbuch der Anorganische Chemie, system number 19, Verlag Chemie GmbH, Weinheim, p. 437.
- [15] B. Aurivillius and L. G. Sillén, *Nature* **155** (1945) 305.
- [16] G. Gattow and D. Schütze, *Z. Anorg. Alg. Chem.* **328** (1964) 44.
- [17] E. M. Levin and R. S. Roth, *J. Res. Nat. Bur. Stand.* **68A** (1964) 197.
- [18] J. D. Tretjakow and H. Schmalzried, *Ber. Bunsenges. Phys. Chem.* **69** (1965) 396.
- [19] T. Takahashi, K. Ito and H. Iwahara, *Rev. Energ. Primaire* **2** (1966) 42.
- [20] T. Takahashi and H. Iwahara, *Denki Kagaku* **34** (1966) 254.
- [21] J. Hladik, in 'Physics of Electrolytes', Vol. 2. (edited by J. Hladik) Academic Press, London, New York (1972) p. 850.