

## New Polymer Tensiometers: Measuring Matric Pressures Down to the Wilting Point

Gerben Bakker, Martine J. van der Ploeg,\* Gerrit H. de Rooij, Cornelis W. Hoogendam, Hermanus P. A. Gooren, Cindy Huiskes, Luuk K. Koopal, and Henk Kruidhof

### ABSTRACT

Tensiometers are commonly used for measuring soil water matric pressures. Unfortunately, the water-filled reservoir of conventional tensiometers limits their applicability to soil water matric pressures above approximately  $-0.085$  MPa. Tensiometers filled with a polymer solution instead of water are able to measure a larger range of soil water matric pressures. We designed and constructed six prototype polymer tensiometers (previously called osmotic tensiometers) consisting of a wide-range pressure transducer with a temperature sensor, a stainless steel casing, and a ceramic plate with a membrane preventing polymer leakage. A polymer chamber ( $0.1$ – $2.2$  cm<sup>3</sup>) was located between the pressure transducer and the plate. We tested the polymer tensiometers for long-term operation, the effects of temperature, response times, and performance in a repacked sandy loam under laboratory conditions. Several months of continuous operation caused a gradual drop in the osmotic pressure, for which we developed a suitable correction. The osmotic potential of polymer solutions is temperature dependent, and requires calibration before installation. The response times to sudden and gradual changes in ambient temperature were found to be affected by polymer chamber height and polymer type. Practically useful response times ( $<0.2$  d) are feasible, particularly for chambers shorter than  $0.20$  cm. We demonstrated the ability of the instrument to measure the range of soil water pressures in which plant roots are able to take up water (from  $0$  to  $-1.6$  MPa), to regain pressure without user interference and to function properly for time periods of up to  $1$  yr.

THE DRIVING FORCE for water flow in soils is the gradient in the total water potential,  $\psi_t$  (J kg<sup>-1</sup>). This potential is defined as the amount of useful work per unit mass of pure water that must be done by means of externally applied forces to transfer reversibly and isothermally an infinitesimal amount of water from a reference reservoir to the soil liquid phase at the point under consideration (Bolt, 1976). The total water potential is generally written as the sum of constituent potentials, most commonly the gravitational ( $\psi_g$ ), matric ( $\psi_m$ ), and osmotic ( $\psi_o$ ) potentials, as follows:

$$\psi_t = \psi_g + \psi_m + \psi_o \quad [1]$$

G. Bakker, ALTERRA, Wageningen Univ. and Research Centre, Droevendaalsesteeg 4, 6708 PB, Wageningen, the Netherlands; M.J. van der Ploeg, G.H. de Rooij, and H.P.A. Gooren, Dep. of Environmental Sciences, Soil Physics, Ecohydrology and Groundwater Management Group, Wageningen Univ. and Research Centre, Droevendaalsesteeg 4, 6708 PB, Wageningen, the Netherlands; C.W. Hoogendam and L.K. Koopal, Lab. for Physical Chemistry and Colloid Science, Wageningen Univ. and Research Centre, Dreijenplein 6, 6703 HB, Wageningen, the Netherlands; C. Huiskes and H. Kruidhof, Faculty of Science and Technology, Twente Univ., Langezijds LA 1727, P.O. Box 217, 7500 AE, Enschede, the Netherlands. Received 10 Aug. 2006. \*Corresponding author (martine.vanderploeg@wur.nl).

Published in Vadose Zone Journal 6:196–202 (2007).

Original Research

doi:10.2136/vzj2006.0110

© Soil Science Society of America

677 S. Segoe Rd., Madison, WI 53711 USA

Equation [1] assumes that the soil liquid phase is dilute enough so that the osmotic potential can be added to the other potentials (Corey and Klute, 1985; Hillel, 1998). In this study, the soil water potential is expressed in terms of energy per volume (pressure equivalent).

Tensiometers are widely used for measuring soil water matric pressures under field and laboratory conditions. Its measurement principle is based on the use of a water-filled reservoir enclosed by a pressure transducer and a water-saturated ceramic tip that is in contact with the soil. Equilibrium between the liquid phase in the soil and in the tensiometer makes it possible to determine the soil water matric pressure. Direct measurement of matric pressures with conventional tensiometers (CTs) is restricted to values greater than approximately  $-0.085$  MPa (Cassel and Klute, 1986; Koorevaar et al., 1983; Young and Sisson, 2002). Most plants can take up water down to matric pressures of about  $-1.6$  MPa. To determine the matric pressures below the tensiometer range, thermocouple psychrometers and relative humidity sensors can be used; however, thermocouple psychrometers have a slow response and are subject to significant measurement errors above  $-1.0$  MPa, while relative humidity sensors seem to be more suitable for measurements below  $-2.0$  MPa (Andraski and Scanlon, 2002; Agus and Schanz, 2005). Other field methods measure the volumetric water content and infer the matric pressure from the soil water characteristic (Klute, 1986; Dane and Hopmans, 2002).

Recognizing the desirability of direct matric pressure measurements throughout an extended range, Peck and Rabbidge (1966, 1969) proposed an osmotic tensiometer. Its principle is based on the osmotic potential of a highly concentrated hydrophilic polymer solution. The soluble polymer molecules are retained inside the osmotic tensiometer by a ceramic membrane that is permeable to the soil solution, but impermeable to the polymers. The osmotic potential of the polymer solution strongly reduces the total water potential inside the osmotic tensiometer (Hillel, 1998). The reduction in the total water potential then causes buildup of a positive pressure inside the tensiometer. Consequently, water in an osmotic tensiometer at equilibrium with a drying soil will cavitate at a much lower soil water pressure than essentially pure water in a CT. The positive pressure inside the osmotic tensiometer can thus be related to the negative matric pressure.

Although Peck and Rabbidge (1966, 1969) were able to construct an osmotic tensiometer capable of measuring matric pressures in the range of  $0$  to  $-1.5$  MPa, their instrument suffered from slow equilibration times

**Abbreviations:** CT, conventional (water-filled) tensiometer; POT, polymer tensiometer; TDR, time domain reflectometer.

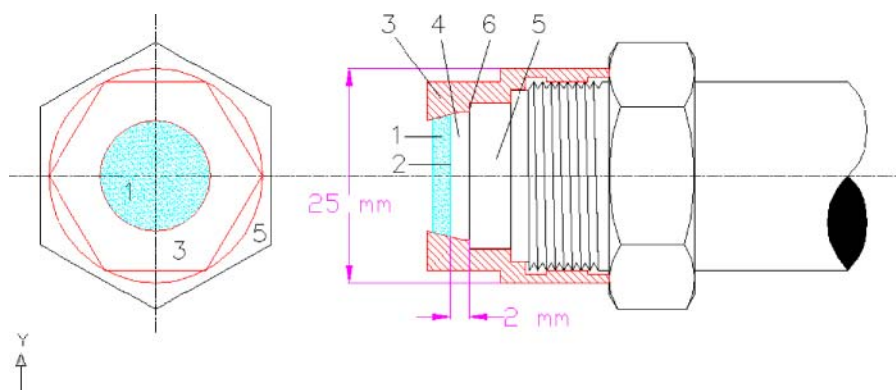

**Fig. 1.** Polymer tensiometer with disk-shaped ceramic containing an  $\alpha$ - $\text{Al}_2\text{O}_3$  support layer (1), a  $\gamma$ - $\text{Al}_2\text{O}_3$  membrane (2), a stainless steel cup (3), a polymer chamber (4), a pressure transducer (5), and a synthetic ring (6). Different polymer chamber volumes were obtained by adjusting the length of the stainless steel cup between the two arrows.

(0.33–1.76 h), temperature effects, unknown zero drift, and gradual reduction in the osmotic pressure inside the instrument ( $3.46 \times 10^{-4}$  to  $4.34 \times 10^{-4}$  MPa  $\text{d}^{-1}$ ). Progress since then has been limited (Peck and Rabbidge, 1969; Bocking and Fredlund, 1979), possibly because of technological limitations at that time (e.g., poorly defined size distributions of the polymer molecules). More recently, Biesheuvel et al. (1999, 2000) reported new osmotic tensiometer designs, which were tested in a limited set of laboratory experiments (no installation in soil material).

We used the design of Biesheuvel et al. (1999) as a starting point for the development of our polymer tensiometer (POT). The term *polymer tensiometer* is used here to avoid frequent confusion with osmometers (e.g., Moses et al., 2003). We tested different polymers for durability and temperature behavior, tried to minimize the response time of the POT, and tested their operation in a soil. The objective of this study was to develop the POT design and its operational procedures, test the design under various conditions, and compare our results with previous instrument performance (Peck and Rabbidge, 1969; Bocking and Fredlund, 1979; Biesheuvel et al., 1999).

## MATERIALS AND METHODS

Our POT (Fig. 1) consists of a flat solid ceramic disk, a stainless steel polymer chamber cup, an aqueous polymer solution, and a pressure transducer. The porous inorganic ceramic disk was made of an  $\alpha$ - $\text{Al}_2\text{O}_3$  support layer and a meso-porous  $\gamma$ - $\text{Al}_2\text{O}_3$  membrane (Everett, 1972; Alami-Younssi et al., 1995; De Vos and Verweij, 1998). The  $\gamma$ - $\text{Al}_2\text{O}_3$  membrane very efficiently prevented leakage of large polymers ( $>20$  kg  $\text{mol}^{-1}$ ) from the polymer chamber (Biesheuvel et al., 1999). The ceramic was glued into the polymer chamber cup.

The pressure transducer (Type PR55–20, Keller Instruments, Winterthur, CH) registered a pressure relative to the atmosphere. The transducer had a range of  $-0.175$  to  $2.201$  MPa, and an accuracy of  $2.38 \times 10^{-3}$  MPa. A temperature sensor ( $0$ – $40^\circ\text{C}$ , accuracy  $0.01^\circ\text{C}$ ) measured temperatures just behind the polymer chamber. We used a  $0.2$ -mm synthetic ring inside the instrument to seal the connection between pressure transducer and the polymer chamber cup.

The polymer chamber was filled with dry polymer. Upon placement in demineralized water ( $20.0^\circ\text{C}$ ), the ceramic saturated instantly and wetted the hydrophilic polymer, leading to a buildup of osmotic pressure and the release and dissolution of entrapped air. In principle, when the osmotic pressure of the polymer solution matched the pressure transducer range, our POT could measure down to a matric pressure of approximately  $-2.0$  MPa.

We selected polymers that were water soluble in the temperature range relevant for plant growth, and which had few or no charged groups in their molecules to minimize the effects to the salinity of the soil solution. We preferred synthetic over natural polymers to prevent bacterial breakdown. Polyethyleneglycol (PEG), polyacrylamide (PAM), and polyvinylpyrrolidone (PVP) were found acceptable for our applications. Table 1 lists selected properties of these polymers.

## Water Reservoir Tests

We investigated temperature behavior, long-term stability, and rewetting behavior by filling the POTs with the polymers and placing them in a temperature-controlled water reservoir (accuracy  $\pm 0.1^\circ\text{C}$ ). Table 2 gives the properties of the POTs that were used. Pressures and temperatures inside each POT were recorded every 10 min. The schematic in Fig. 2 outlines our subsequent experiments.

## Block and Sinusoidal Temperature Waves

The osmotic potential of a polymer solution generally depends on temperature. A key parameter of the temperature

**Table 1.** Properties of the polymers used in the polymer tensiometers.

Polymer (trade name)	Polymer type	Average molar mass $\text{kg mol}^{-1}$	Anionic groups <sup>†</sup> %	Temperature of phase separation <sup>‡</sup>
PAM FLUKA	Polyacrylamide (21.6% cross-linked)	500	1	$< -35^\circ\text{C}$
PEG 4000	Polyethyleneglycol	4000	0	$< -15^\circ\text{C}; > 95^\circ\text{C}$
Praestol 2500	Polyacrylamide	2500	1	$< -35^\circ\text{C}$
PVP 40000	Polyvinyl-pyrrolidone	40	0	$> 135^\circ\text{C}$

<sup>†</sup> Davidson (1980, p. 16–2).

<sup>‡</sup> When dissolved in water (Molyneux, 1983, p. 11, Fig. 1).

**Table 2. Overview of the polymer chamber geometry and the polymers used in six polymer tensiometers (POTs).**

POT	Chamber depth	Chamber volume	Polymer	Mass of polymer
	cm	cm <sup>3</sup>		g
1	1.0	2.1	PAM FLUKA	0.45
2	1.0	2.2	PVP40000	0.65
3	1.0	1.9	Praestol	0.66
4	0.20	0.7	Praestol	0.31
5	0.05	0.1	Praestol	0.072
6	0.05	0.1	PEG4000	0.044

dependency is the dimensionless Flory–Huggins interaction parameter (Flory, 1941, 1942; Huggins, 1942a, 1942b). A POT's response to temperature changes is determined by the temperature dependency of the osmotic pressure (given by the temperature coefficient  $\alpha$  [Pa °C<sup>-1</sup>]), together with various thermal expansion coefficients of POT components, and the dynamics of the temperature front traveling through the instrument. To determine the temperature coefficient, we subjected the POTs to both abrupt (block-type) and sinusoidal temperature variations within the water bath (Table 3). The selected intervals between the imposed block-type temperature changes depended on the POT's response time (up to a maximum of 7 d) and allowed the pressure to stabilize in most cases. The various polymer types and concentrations of the individual POTs required different temperature ranges. The amplitude was chosen such that the maximum pressure in the polymer chamber would not exceed the range of the pressure transducer.

### Long-Term Behavior and Rewetting

Before, between, and after applying the two types of temperature variations, the temperature was fixed at 20.0°C for extended periods of time to establish the long-term behavior of the pressure inside the POTs and to determine the effect of the temperature experiments on long-term behavior. A major advantage of POTs over CTs is the fact that they should be able to rewet spontaneously after drying out. We therefore exposed POT 2 and POT 4 (Table 2) to air at a relative humidity of 60% (having an equivalent matric potential [ $p$ ] of -67.66 MPa) for 72 h, and subsequently submerged them in water (20.0°C).

### Repacked Soil Experiments

To test the POTs in a drying soil, we constructed an evaporation container (0.40 by 0.30 by 0.40 m, length by width by

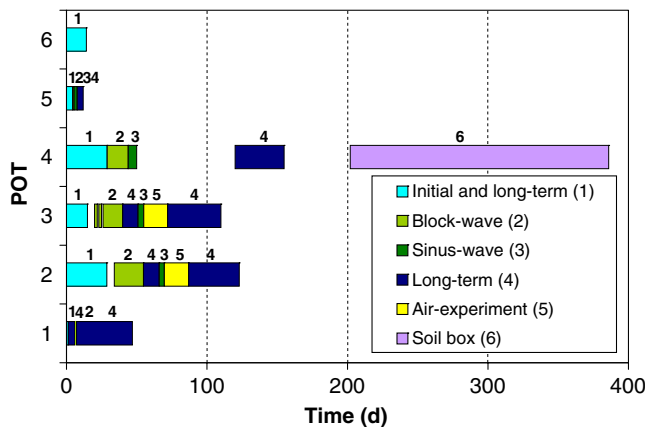

**Fig. 2. Overview of the various experiments with six polymer tensiometers (POTs, Table 2), involving temperature effects (2, 3), drying and rewetting (5), performance in soil material (6), and long-term stability (1, 4).**

**Table 3. Imposed temperature variations for the block- and sinus-wave temperature experiments using the polymer tensiometers (POTs) of Table 2, including increments for the block-wave experiments and the periods for the sinus-wave experiments.**

POT no.	Block wave			Sinus wave			
	Temperature		Increments	Temperature		Period	
	Min.	Max.		Min.	Max.		
	°C						h
1	15.0	25.0	5.0	-	-	-	
2	1.0	50.0	4.0, 5.0, 10.0	0.0	40.0	24	
3	1.0	50.0	4.0, 5.0, 10.0	0.0	40.0	12	
4	1.0	40.0	4.0, 5.0, 10.0	10.0	30.0	24	
5	1.0	35.0	4.0, 5.0, 10.0	10.0	30.0	12	
6	-	-	-	-	-	-	

height) with a perforated bottom, and with vapor outlet ports that connected to wall-to-wall perforated polyvinyl chloride tubes (outer diameters of 20 mm). The ports considerably shortened the pathways of water vapor to the atmosphere, thus allowing soil to dry out rapidly, even at greater depths. We packed Richmond sandy loam (14% clay, 31% silt, 55% sand) uniformly in the container, and then installed various sensors (POT 4, time domain reflectometer [TDR], CT).

At the start of the experiments, the soil was saturated with unchlorinated tap water, and then allowed to drain and evaporate. Tests indicated that the low salinity of the soil solution did not significantly affect the readings of POT 4. During the drying phase, gravimetric water contents were determined on 20-cm<sup>3</sup> cylindrical soil samples for the purpose of calibrating the TDR sensor and determining the soil water retention curve.

## RESULTS AND DISCUSSION

### Water Reservoir Tests

The results of the water reservoir tests deal with the pressure inside the polymer chamber only, and are therefore given in positive pressure values. Figures 3 and 4 show the pressure buildup when the dry POTs were placed in water. The pressure peak probably resulted from enclosed air in the polymer chamber. The enclosed air reduced the volume of the polymer solution, thereby leading to a higher concentration. When air diffused out of the polymer chamber, the volume of the polymer solution increased, again leading to a drop in pressure. The subsequent gradual pressure decrease is possibly caused by polymer degradation, or maybe by diffusion of some

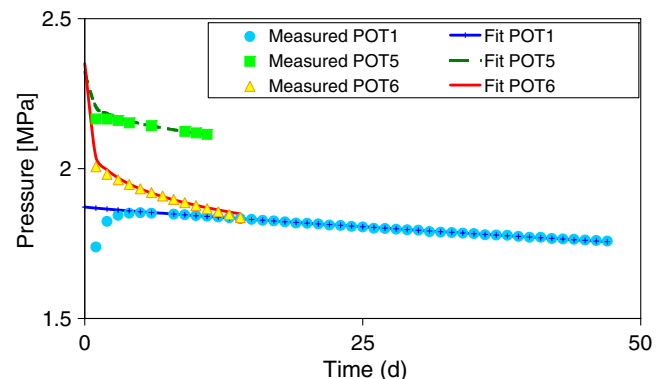

**Fig. 3. Initial pressure peaks and long-term pressure drops for polymer tensiometers (POTs) 1, 5, and 6 (Table 2) when placed in water.**



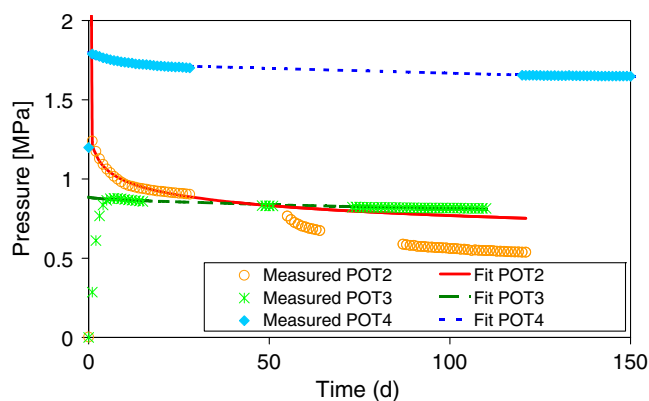

Fig. 4. Initial pressure peaks and long-term pressure drops for polymer tensiometers (POTs) 2, 3, and 4 (Table 2) when placed in water.

smaller sized polymer molecules through the porous membrane (Caulfield et al., 2003).

### Block and Sinusoidal Temperature Waves

When the POTs were subjected to an abrupt temperature change, the pressure responded immediately and with high peaks (Fig. 5 shows POT 3). The high peaks prolonged equilibration times during which readings were unreliable; they could also damage the pressure sensor. The temperature response times (time to reach an equilibrium pressure within 1% after a temperature step) are given in Table 4. The equilibrium pressure was defined as the average pressure of the last 100 observations, including the range of noise of those observations (the maximum observed noise range of all POTs was  $4.2 \times 10^{-3}$  MPa,  $5.52 \times 10^{-4}$  MPa lower than the given manufacturer's range). The POTs we tested had temperature response times (Table 4) that were mostly shorter than the 0.33 d reported by Bocking and Fredlund (1979).

The temperature response times of the POTs were found to depend on polymer type and polymer chamber height, but again not on the magnitude of the pressure. The height of the polymer chamber affected the response time, possibly through its influence on the travel distance of water through the polymer solution or the

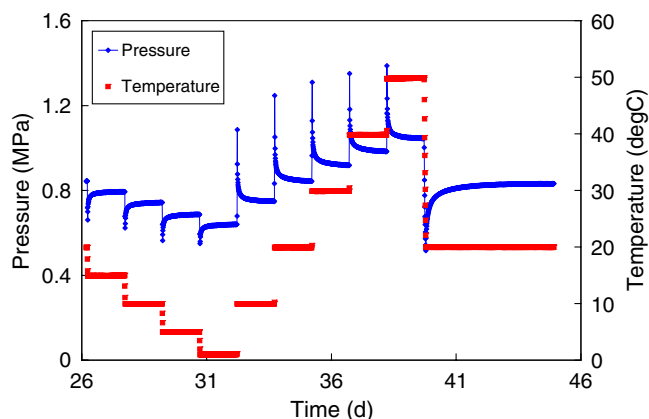

Fig. 5. Pressure response of polymer tensiometer (POT) 3 (Table 2) to abrupt temperature changes using a water bath.

Table 4. Averaged temperature response times of the polymer tensiometers (POTs) listed in Table 2 to sudden temperature changes.

POT no.	Polymer	Chamber depth cm	Temperature response time averaged across the number of experiments (n) per temperature change			
			10°C drop	5°C drop	10°C rise	5°C rise
1	PAM FLUKA	1.0	-	0.034 (1)	-	0.034 (1)
2	PVP40000	1.0	-	0.051 (3)	0.445 (4)	-
3	Praestol	1.0	-	0.343 (3)	0.474 (4)	-
4	Praestol	0.20	0.174 (1)	0.156 (5)	0.136 (2)	-
5	Praestol	0.050	-	0.010 (6)	0.014 (2)	0.012 (2)

compressibility of the polymer solution. Biesheuvel et al. (1999) tried to model the response time by assuming that it was determined entirely by the sensitivity of the pressure transducer ( $S$  [ $\text{Pa m}^{-3}$ ]) and the conductivity of the ceramic ( $K$  [ $\text{m}^3 \text{s}^{-1} \text{Pa}^{-1}$ ]). Their model hence implies that the size of the polymer chamber has no effect, which is contrary to our data. Furthermore, we calculated values of the product  $SK$  from  $S$  values given by the manufacturer and measured  $K$  values as reported by Biesheuvel et al. (1999). The  $SK$  values thus obtained differed several orders of magnitude from the  $SK$  values ( $\text{s}^{-1}$ ) fitted by Biesheuvel et al. (1999) to their experimental temperature-response data. This indicates that the temperature response time of their instrument, which is quite similar to our large-chamber POTs, was much larger than what could be attributed to  $S$  and  $K$ .

The validity of Biesheuvel et al.'s (1999) assumption of an incompressible fluid can be tested if we assume that the compressibility of the polymer solution is similar to that of pure water. At 25°C, a pressure increase of 1.0 MPa leads to a  $4.6 \times 10^{-11} \text{ m}^3$  volume reduction of water for a 0.10- $\text{cm}^3$  polymer chamber (the smallest chamber in Table 2; Lide, 2005). Biesheuvel et al. (1999) reported sensitivities between  $1.0 \times 10^{-12} \text{ Pa m}^{-3}$  for traditional pressure transducers, to  $3.0 \times 10^{-17} \text{ Pa m}^{-3}$  for a newer transducer, leading to volume changes of  $1.0 \times 10^{-6}$  and  $3.3 \times 10^{-12} \text{ m}^3$ , respectively. This suggests that even for the smallest polymer chamber, the assumption of an incompressible fluid is invalid for the new pressure transducer. We conclude that the assumptions of insensitivity to chamber size and having an incompressible fluid in Biesheuvel et al.'s (1999) model are of limited practical use.

The equilibrium pressures of the block-wave experiments were used to determine the pressure-temperature relationships for all POTs. To more effectively compare the relationships, we scaled the pressures with  $(P_T - P_0)/P_0$  and the temperatures with  $(T - T_0)/T_0$ , where  $P_T$  (MPa) is the pressure at temperature  $T$  (°C), and  $P_0$  (MPa) is the reference pressure at reference temperature  $T_0$  (°C). Table 5 gives values of  $P_0$  and  $T_0$  for each POT. The various linear expansion coefficients of the materials, and the nonlinear temperature dependency of the osmotic potential of the polymer solution used in the instrument resulted in slightly curved pressure-temperature relationships, as shown in Fig. 6. The pressure-temperature

**Table 5. Parameters of the temperature–pressure relationship (Eq. [2]) for polymer tensiometers (POTs) 1 to 5 listed in Table 2.**

POT	$T_0$ °C	$P_0$ MPa	$A$	$B$	$C$	$R^2$
1	20.0	1.85	-0.0528	0.1490	0.00009	1
2	19.9	1.35	0.0216	-0.1444	-0.0085	0.9954
3	19.9	0.87	-0.0351	0.2114	-0.0072	0.9988
4	19.9	1.75	-0.0231	0.1938	0.0007	0.9999
5	19.9	2.19	-0.0187	0.2438	0.0009	0.9999

relationships could be fitted well with a second-degree polynomial of the form

$$\frac{P_T - P_0}{P_0} = A \left( \frac{T - T_0}{T_0} \right)^2 + B \left( \frac{T - T_0}{T_0} \right) + C \quad [2]$$

where  $A$ ,  $B$ , and  $C$  are fitting parameters. The various polymer concentrations produced different values of the fitting parameters (Table 5). The polymers we used all had a positive temperature–pressure dependency, except PVP 40000, which showed a decrease in pressure with increasing temperature.

A sinusoidal temperature wave is more representative of field conditions than a sudden rise or drop in temperature. Figure 7 shows that no anomalous peaks were observed for the imposed sinusoidal waves for POT 3. The measured temperature inside the pressure sensor lagged behind the pressure response, for which we have no good explanation. The temperature sensor inside the POT showed a delay of 2 to 4 min compared with the observed temperature of the water reservoir (as measured with another thermometer), which did not explain the lag of approximately 80 min in Fig. 7. The reversal of the thermal expansion for water around 4°C had no visible effect on the response of POT 3. Polymer tensiometers 2, 4, and 5 showed similar results (POT 1 and POT 6 were not subjected to a sinusoidal temperature wave).

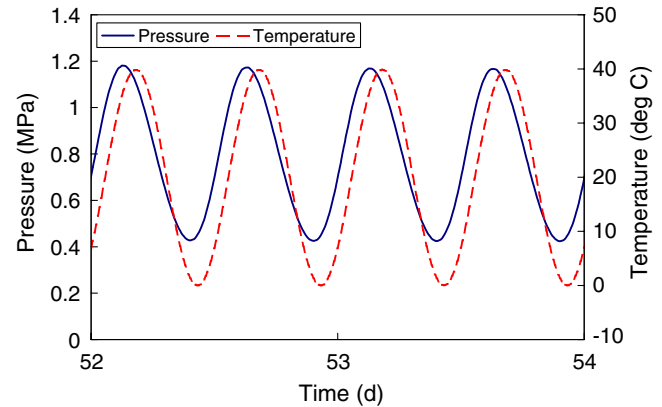

**Fig. 7. Pressure response of polymer tensiometer (POT) 3 (Table 2; placed in water) to a sinus temperature wave.**

### Long-Term Behavior and Rewetting

The periods between the various temperature response experiments were used to study the long-term stability of the POTs (Fig. 3 and 4). The observed gradually decreasing osmotic pressures were fitted with

$$p(t) = b \exp - (t/\tau)^c \quad [3]$$

where  $b$  (Pa),  $\tau$  (d), and  $c$  are adjustable parameters. Pressures before the peaks in Fig. 3 and 4 were not used for fitting. Table 6 shows the pressure decay, the fitted parameter values, and the coefficient of determination ( $R^2$ ) for all POTs. Large values for  $\tau$  imply a slow pressure decay. The pressure decay after 100 d for POT 3 and POT 4 was equal to or slightly less than those reported by Peck and Rabbidge (1969). The pressure decay we observed gradually became less (exponential decay), however, while Peck and Rabbidge (1969) observed a more linear relationship with time for the pressure decay.

The temperature response experiments that were imposed in between the long-term experiments seemed to

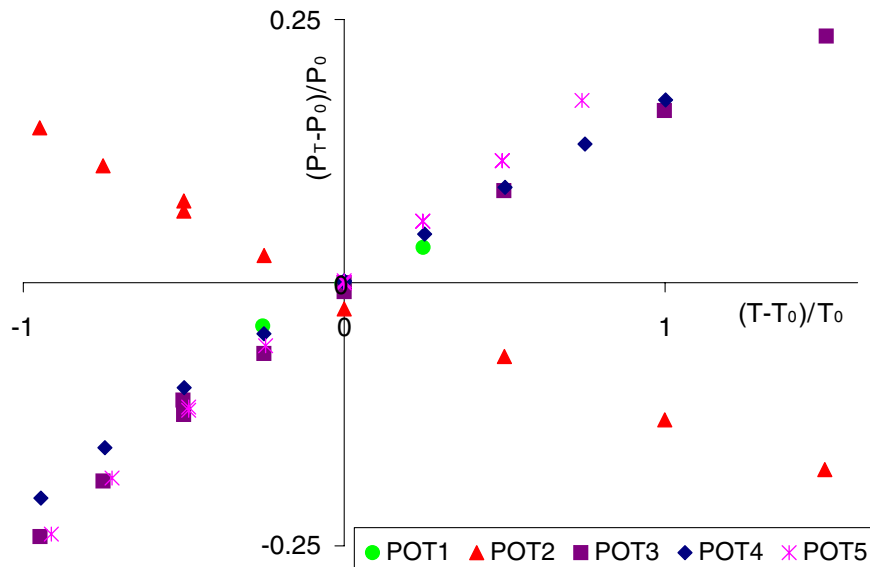

**Fig. 6. Scaled pressure ( $P$ )–temperature ( $T$ ) relationships for the polymer tensiometers (POTs, Table 2) when placed in water.**

**Table 6. Parameters in Eq. [3] describing the long-term pressure decay of the polymer tensiometers (POTs) listed in Table 2.**

POT no.	Pressure decay shortly after pressure peak (Days 11–12)	Pressure decay after 100 d	$b$	$\tau$	$c$	$R^2$
	$\text{kPa d}^{-1}$	MPa				
1	2.57	–	1.872	$9.48 \times 10^2$	0.9166	0.9991
2	8.73	0.726	6.265	$1.54 \times 10^{-4}$	0.0553	0.9906
3	1.03	0.405	0.8853	$5.62 \times 10^3$	0.6138	0.9798
4	1.89	0.337	1.796	$1.36 \times 10^5$	0.3572	0.9893
5	4.41	–	2.320	$1.26 \times 10^5$	0.2540	0.9887
6	7.41	–	2.350	$1.90 \times 10^4$	0.1978	0.9916

have no effect on the pressure decay for most POTs, thus suggesting that the parameters in Eq. [3] are independent of temperature. The PVP 40000 inside POT 2 showed a pressure collapse (Fig. 4) after a large pressure increase during the temperature experiments, which could not be explained by long-term pressure decay. We observed similar pressure collapses after a large pressure increase during the temperature experiments in several POTs containing PVP 40000 (data not further shown here). PVP 40000 hence seems to be a less suitable polymer for use in POTs.

The parameters of Eq. [2] and [3] for long-term operation can be determined during initial testing before field installation. This allows the POT field readings to be properly corrected during the entire operational period. To do so, one must first calculate the osmotic potential of the POT at the desired time for the selected (arbitrary) reference temperature from Eq. [3] (Table 6). The actual osmotic potential for the ambient temperature is then derived using the pressure–temperature relationship given by Eq. [2] (Table 5) of the sensor of interest. The matric potential subsequently follows from Eq. [1].

A key advantage of POTs over CTs is presumably their ability to refill spontaneously with water after drying out. We tested this ability by removing POT 3 from the water reservoir at Day 58 and immersing it again at Day 61 (Fig. 2). Figure 8 shows the pressure response. The pressure responded within minutes, which is considerably faster than the response time observed by Peck and Rabbidge (1969). When placed in water, the POT

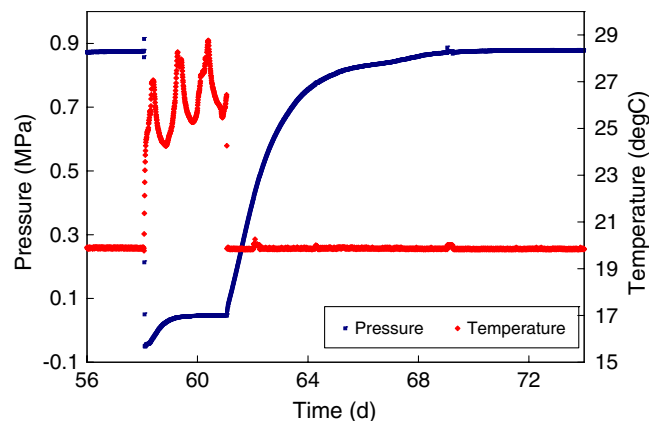

**Fig. 8. Self-restoring capacity of polymer tensiometer (POT) 3 (Table 2). The tensiometer was temporarily removed from the water reservoir between Days 58 and 61.**

rapidly rewetted and recovered to its original osmotic pressure (corrected for the long-term trend) within 9 d. The overshoot observed during initial wetting (Fig. 3) did not occur, possibly because the polymer retained sufficient water to prevent significant air entry into the polymer chamber. Another possibility may be that the dried polymer compacted too much for air to be entrapped between polymer grains, thus allowing the air to be easily expelled during rewetting. Tensiometer POT 2 gave similar results, which are not further shown here.

## Repacked Soil Experiment

During the evaporation experiment with repacked soil, the atmospheric demand remained fairly low for the first 140 to 150 d, resulting in slow drying. The humidity then decreased, leading to a higher evaporation rate and hence increased soil drying. All sensors in the soil container responded consistently (Fig. 9). Data from POT 4 were corrected for the ambient temperature variations and the long-term pressure decay, and converted to matric pressures. The TDR data were converted to matric pressures using a soil-specific calibration curve and the measured soil water retention curve. Data from the 2 CTs were averaged.

The measurement range of the POT was clearly much larger than that of the CT, and exceeded the wilting point. At the conclusion of the experiments (183 d, 385 d since the initial start), POT 4 reached its limit and dried out. Together with its ability to rewet spontaneously, this demonstrates that a POT is able to function in a soil environment during an entire growing season. Relatively small deviations between POT 4 and the CT and TDR results in the wet range between 50 and 150 d were probably caused by limited contact between the POT's flat ceramic and the soil. In the dry range, the TDR-derived matric pressures deviated from the POT observations. The TDR benchmark in this range was probably less reliable since TDR readings at water contents below about 0.10 are less accurate than those of a wetter soil.

## CONCLUSIONS

In summary, we demonstrated the ability of a recently designed polymer tensiometer to measure matric pres-

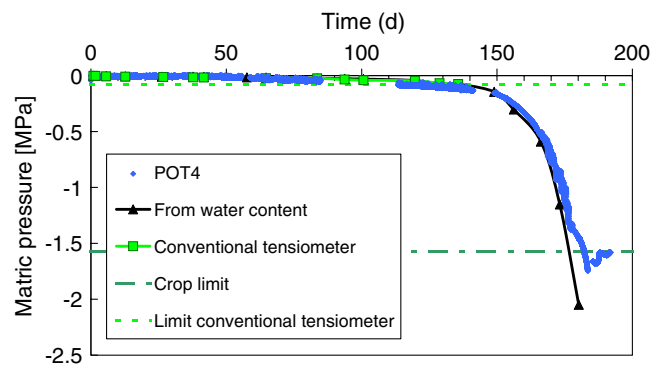

**Fig. 9. Matric pressures recorded by different instruments placed in soil. Day 0 in the figure corresponds with Day 202 in Fig. 2. Table 2 lists key features of polymer tensiometer (POT) 4.**

tures beyond the wilting point and to function properly for time periods comparable to a growing season. Temperature effects and the long-term pressure decay can be adequately quantified and corrected. Temperature response times were affected by polymer chamber height; small polymer chambers were found to work best.

The polymer tensiometer appears very attractive for field applications because of its much wider measurement range and fast pressure response. While less of a problem for field applications, the pressure response to abrupt temperature changes needs consideration in the design of laboratory experiments. Future research should address the shape of the ceramic tip to ensure better contact with the soil, and the long-term integrity of polymers in polymer tensiometers installed in soils.

#### ACKNOWLEDGMENTS

This research was supported by the Dutch Technology Foundation STW, Applied Science Division of NWO, and the technology program of the Ministry of Economic Affairs of the Netherlands.

#### REFERENCES

- Agus, S.S., and T. Schanz. 2005. Comparison of four methods for measuring total suction. *Vadose Zone J.* 4:1087–1095.
- Alami-Younssi, S., A. Larbot, M. Persin, J. Sarrazin, and L. Cot. 1995. Rejection of mineral salts on a gamma alumina nanofiltration membrane: Application to environmental process. *J. Membr. Sci.* 102: 123–129.
- Andraski, B.J., and B.R. Scanlon. 2002. Thermocouple psychrometry. p. 609–642. *In* J.H. Dane and G.C. Topp (ed.) *Methods of soil analysis*. Part 4. SSSA Book Ser. 5. SSSA, Madison, WI.
- Biesheuvel, P.M., R. Raangs, and H. Verweij. 1999. Response of the osmotic tensiometer to varying temperatures: Modeling and experimental evaluation. *Soil Sci. Soc. Am. J.* 63:1571–1579.
- Biesheuvel, P.M., A.P. van Loon, R. Raangs, H. Verweij, and C. Dirksen. 2000. A prototype osmotic tensiometer with polymeric gel grains. *Eur. J. Soil Sci.* 51:355–364.
- Bocking, K.A., and D.G. Fredlund. 1979. Use of the osmotic tensiometer to measure negative pore water pressure. *Geotech. Test. J.* 2(1): 3–10.
- Bolt, G.H. 1976. Soil physics terminology. *Bull. Int. Soc. Soil Sci.* 49: 26–36.
- Cassel, D.K., and A. Klute. 1986. Water potential: Tensiometry. p. 563–596. *In* A. Klute (ed.) *Methods of soil analysis*. Part 1. 2nd ed. SSSA Book Ser. 5. SSSA, Madison, WI.
- Caulfield, M.J., X. Hao, G.G. Qiao, and D.H. Solomon. 2003. Degradation on polyacrylamides. Part I. Linear polyacrylamide. *Polymer* 44:1331–1337.
- Corey, A.T., and A. Klute. 1985. Application of the potential concept to soil water equilibrium and transport. *Soil Sci. Soc. Am. J.* 49:3–11.
- Dane, J.H., and J.W. Hopmans. 2002. Water retention and storage. p. 671–673. *In* J.H. Dane and G.C. Topp (ed.) *Methods of soil analysis*. Part 4. SSSA Book Ser. 5. SSSA, Madison, WI.
- Davidson, R.L. (ed.). 1980. *Handbook of water-soluble gums and resins*. McGraw-Hill, New York.
- De Vos, R.M., and H. Verweij. 1998. Improved performance of silica membranes for gas separation. *J. Membr. Sci.* 143:37–51.
- Everett, D.H. 1972. *Manual of symbols and terminology for physico-chemical quantities and units*. Appendix II. Definitions, terminology and symbols in colloid and surface chemistry, Part I. *Pure Appl. Chem.* 31:579–638.
- Flory, P.J. 1941. Thermodynamics of high polymer solutions. *J. Chem. Phys.* 9:660–661.
- Flory, P.J. 1942. Thermodynamics of high polymer solutions. *J. Chem. Phys.* 10:51–61.
- Hillel, D. 1998. *Environmental soil physics*. Academic Press, San Diego.
- Huggins, M.L. 1942a. Theory of solutions of high polymers. *J. Am. Chem. Soc.* 64:1712–1719.
- Huggins, M.L. 1942b. Some properties of solutions of long-chain compounds. *J. Phys. Chem.* 46:151–158.
- Klute, A. 1986. Water retention: Laboratory methods. p. 635–686. *In* A. Klute (ed.) *Methods of soil analysis*. Part 1. 2nd ed. SSSA Book Ser. 5. SSSA, Madison, WI.
- Koorevaar, P., G. Menelik, and C. Dirksen. 1983. *Elements of soil physics*. Dev. Soil Sci. 13. Elsevier, Amsterdam.
- Lide, D.R. (ed.). 2005. *CRC Handbook of chemistry and physics*. 86th ed. CRC Press, Boca Raton, FL.
- Molyneux, P. 1983. *Water-soluble synthetic polymers: Properties and behavior*. Vol. 1. CRC Press, Boca Raton, FL.
- Moses, C.L., L.P.N. Rebelo, and W.A. Van Hook. 2003. Membrane osmometer for use at moderate applied pressures. *J. Polym. Sci. Part B: Polym. Phys.* 41:3064–3069.
- Peck, A.J., and R.M. Rabbidge. 1966. Soil-water potential: Direct measurement by a new technique. *Science* 151:1385–1386.
- Peck, A.J., and R.M. Rabbidge. 1969. Design and performance of an osmotic tensiometer for measuring capillary potential. *Soil Sci. Soc. Am. Proc.* 33:196–202.
- Young, M.H., and J.B. Sisson. 2002. Tensiometry. p. 575–608. *In* J.H. Dane and G.C. Topp (ed.) *Methods of Soil Analysis*. Part 4. SSSA Book Ser. 5. SSSA, Madison, WI.