

INTERFACIAL AREAS AND GAS HOLD-UPS IN GAS-LIQUID CONTACTORS AT ELEVATED PRESSURES FROM 0.1 TO 8.0 MPa

M. H. OYEVAAR,[†] R. BOS and K. R. WESTERTERP[‡]

Chemical Reaction Engineering Laboratories, Department of Chemical Engineering, University of
Twente, PO Box 217, 7500 AE Enschede, Netherlands

(First received 24 October 1988; accepted in revised form 18 September 1990)

Abstract—Interfacial areas and gas hold-ups have been determined at pressures up to 8.0 MPa in a mechanically agitated gas-liquid reactor and a bubble column with a diameter of 81 mm for superficial gas velocities between 1 and 5 and 1 and 10 cm/s, respectively. The interfacial areas have been determined by the chemical method using the model reaction between CO₂ and aqueous diethanolamine (DEA). Contrary to earlier reported results on interfacial areas in a mechanically agitated reactor at pressures up to 1.7 MPa, a positive influence of pressure on the interfacial areas has been observed for higher pressures and higher superficial gas velocities. The product of the gas density ρ_G and the superficial gas velocity at the orifice $v_{G,or}$ was found to be an important parameter for the manifestation of the pressure effect. For values of $\rho_G v_{G,or}$ larger than 200 kg/m² s the interfacial areas increase with increasing reactor pressure. Below this value of 200 kg/m² s no influence of pressure could be observed. The gas hold-ups in the bubble column in water as well as in an aqueous solution of DEA with antifoam increase with increasing pressure. This pressure effect on the gas hold-up in bubble columns originates from the formation of smaller bubbles at the gas distributor. The relative increase in the gas hold-ups is smaller in water and also if a porous plate instead of a perforated plate is used as gas distributor. The differences in the magnitude of the pressure effect are caused by differences in the coalescence behaviour of the gas bubbles in both liquids and by differences in the bubble formation process at the two types of gas distributors, respectively. The interfacial areas in the bubble column also increase with increasing pressure. The relative increase in the interfacial areas a_p/a_{atm} with increasing pressure may be as large as 200% for a pressure increase from $P = 0.15$ to 8.0 MPa, depending on the type of gas distributor and the superficial gas velocity used.

INTRODUCTION

Many gas-liquid operations in process industry are carried out at elevated pressures. Despite that almost all research on gas-liquid contacting is concerned with atmospheric pressure. Only in recent years has specific attention been paid to the influence of pressure on the hydrodynamics and the mass transfer parameters in gas-liquid contactors operating at elevated pressures:

- for mechanically agitated gas-liquid reactor see Sridhar and Potter (1980a, b),
- for bubble column see Tarmy *et al.* (1984a, b) and Idogawa *et al.*, (1985a, b),
- for packed bubble column see van Gelder and Westerterp (1989),
- for trickle bed reactor see Hasseni *et al.* (1987),
- for sieve tray column see Badssi *et al.* (1988).

These studies indicate that the operating pressure may have a significant effect on the hydrodynamics and the mass transfer parameters in these contactors and that the data as obtained at atmospheric pressure are inadequate for scale-up and design of high-pressure gas-liquid contactors.

Oyevaar and Westerterp (1989) reviewed all studies concerning the influence of pressure on mass transfer phenomena in gas-liquid systems. They concluded that the initial bubble size at a single orifice decreases with increasing pressure, that the gas phase mass transfer coefficient k_G is inversely proportional with pressure to the power n , where n depends on the mass transfer mechanism, that the liquid phase mass transfer coefficient k_L is not influenced by pressure, and that the gas hold-up ϵ_G in a bubble column increases with increasing pressure. The combination of larger gas hold-ups and smaller bubble diameters may lead to considerably larger interfacial areas at elevated pressures. However, in order to support this hypothesis insufficient data on interfacial areas in gas-liquid contactors at elevated pressures are available.

Therefore, Oyevaar *et al.* (1988, 1989) investigated the effect of pressure on interfacial areas and gas hold-ups in several gas-liquid contactors for pressures up to about 2 MPa. They found that in a mechanically agitated gas-liquid reactor and a packed bubble column the interfacial areas and the gas hold-ups are unaffected by pressure. For a bubble column they observed with increasing operating pressure an increase in the interfacial areas as well as in the gas hold-ups. The positive influence of the operating pressure on interfacial areas and gas hold-ups in a bubble column can be attributed to the formation of smaller bubbles at the gas distributor. The other two gas-liquid contactors—the mechanically agitated

[†]Present address: General Electric Plastics bv, Bergen op Zom, Netherlands.

[‡]Author to whom correspondence should be addressed.

reactor and the packed bubble column—exhibit no influence of pressure on interfacial areas and gas hold-ups, because in both contactors the coalescence–breakup process of the bubbles is dominated by the agitator or the packing.

This study is a follow-up of the aforementioned studies of Oyevaar *et al.* (1988, 1989), which were limited in their pressure and superficial gas velocity ranges. We will report on interfacial area determinations in a *mechanically agitated gas–liquid reactor*, equipped with two gas inlets and two turbine impellers of different size, at pressures up to 8.0 MPa and at superficial gas velocities between 1 and 5 cm/s. Furthermore we will discuss our results on interfacial areas and gas hold-ups as determined in a *bubble column*, equipped with a perforated plate or a porous plate as gas distributor, for pressures up to 8.0 MPa and for superficial gas velocities between 1 and 10 cm/s.

EXPERIMENTAL

Experimental method

The interfacial areas are determined by the chemical method using the model reaction between CO₂ and aqueous diethanolamine (DEA). We have shown (Oyevaar *et al.*, 1989) that the absorption rate as derived by Danckwerts (1970) for the penetration theory becomes equal to

$$\begin{aligned}\phi_{\text{CO}_2} &= mk_L a V_R E_A \Delta c_{\text{CO}_2, G} \\ &= mk_L a V_R \sqrt{1 + Ha^2} \Delta c_{\text{CO}_2, G}\end{aligned}\quad (1)$$

where $\Delta c_{\text{CO}_2, G}$ is the average driving force for mass transfer. If the conditions for the pseudo-first-order reaction regime:

$$2 < Ha \ll E_{A, \infty} \quad (2)$$

with

$$Ha = \frac{\sqrt{k_{1,p} c_{\text{DEA}, L}^p D_A}}{k_L} \quad (3)$$

and

$$E_{A, \infty} = \sqrt{\frac{D_A}{D_B}} + \sqrt{\frac{D_B}{D_A} \frac{c_{B, L}}{m c_{A, G} v_B}} \quad (4)$$

are met, the interfacial areas can be obtained from absorption rate measurements without knowledge of the exact value of the liquid phase mass transfer coefficient k_L . The interfacial areas in the reactor can

then be evaluated from

$$a = \frac{\phi_r (c_{\text{CO}_2, G, \text{in}} - c_{\text{CO}_2, G, \text{out}})}{m V_R \sqrt{k_{1,p} c_{\text{DEA}, L}^p D_{\text{CO}_2} \Delta c_{\text{CO}_2, G}}} \quad (5)$$

where the numerator represents the absorption rate of CO₂. Determination of the interfacial area in a gas–liquid contactor with the reaction between CO₂ and DEA in water thus requires knowledge of the driving force for mass transfer of CO₂ and of the absorption rate constant $m[k_{1,p}(c_{B,L})^p D_{\text{CO}_2}]^{0.5}$ of this specific gas–liquid system.

Earlier, Oyevaar *et al.* (1988) determined that in a mechanically agitated gas–liquid reactor realistic values for the interfacial areas are obtained if the residence time distribution (RTD) of the gas phase is taken to be equivalent to that of a continuous stirred tank reactor (CSTR), provided the conversion level of CO₂ in the gas phase is kept below 80%. For a RTD of the gas phase equal to a CSTR the driving force $\Delta c_{\text{CO}_2, G}$ is equal to the CO₂ concentration in the gas outlet:

$$\Delta c_{\text{CO}_2, G} = c_{\text{CO}_2, G, \text{out}} \quad (6)$$

The gas phase in the bubble column reactor can be assumed to be in plug flow and for this case $\Delta c_{\text{CO}_2, G}$ is equal to the logarithmic mean difference between the in- and outlet gas phase concentration:

$$\Delta c_{\text{CO}_2, G} = \frac{c_{\text{CO}_2, G, \text{in}} - c_{\text{CO}_2, G, \text{out}}}{\ln(c_{\text{CO}_2, G, \text{in}}/c_{\text{CO}_2, G, \text{out}})} \quad (7)$$

The same commercial-grade aqueous DEA solutions as in Oyevaar *et al.* (1988, 1989) are used for the determination of interfacial areas in the mechanically agitated reactor and the bubble column. An empirical correlation for the absorption rate constant $m[k_{1,p}(c_{B,L})^p D_{\text{CO}_2}]^{0.5}$ at 298 K in the gas–liquid reaction system as a function of the free DEA concentration (0.2–2.0 mol/kg) is given as eq. (8) in Table 1. Experimentally determined correlations for the solubility m , viscosity μ_L and density ρ_L as a function of the total DEA concentration are also given as eqs (9)–(11) in Table 1.

Experimental installation

Besides the construction of the equipment the major problem in the design of a high-pressure gas–liquid installation is the large consumption of the gas phase reactants and inerts. In order to reduce this large consumption we decided to recycle the gas around the reactor. In Fig. 1 a flow sheet is given of

Table 1. Data for DEA–water system at 298 K

$$m \sqrt{k_{1,p} c_{\text{DEA}, L}^p D_{\text{CO}_2}} = 9.39 \times 10^{-4} [\text{DEA}]_{\text{free}}^{0.38} - 2.61 \times 10^{-4} \text{ m/s} \quad (8)$$

$$m = 0.791 - 0.044 [\text{DEA}]^* \quad (9)$$

$$\rho_L = 995.8 + 15.55 [\text{DEA}] - 1.141 [\text{DEA}]^2 \text{ kg/m}^3 \quad (10)$$

$$\mu_L = 10^{-3} \exp(-0.1135 + 0.257 [\text{DEA}] + 4.694 \times 10^{-2} [\text{DEA}]^2) \text{ N s/m}^2 \quad (11)$$

[DEA] in mol/kg and [DEA]* in mol/l

the experimental installation, which has been designed for absorption experiments up to pressures of 10 MPa [for more specific information see Oyevaar (1989)]. Provisions are made for a quick exchange of the reactor.

The reactors. The geometries of the mechanically agitated gas-liquid reactor ($D = 81$ mm and $H/D = 1$) and the bubble column ($D = 81$ mm and $H/D = 10$) are shown in Figs 2 and 3, respectively. Both contactors operate continuously with respect to the gas and the liquid phase, and are thermostatted at 298 K. The reactors are equipped with two or six glass windows with a diameter of 2 cm. Through these small windows the dispersion level can be determined and also the behaviour of the dispersion can be studied.

The mechanically agitated reactor has been designed according to the standard geometry (Oyevaar *et al.*, 1988). Two standard six-bladed disc turbine impellers of $D_i/D = 0.4$ and 0.5, respectively, are available for agitation. The gas mixture of CO_2 and N_2 is introduced into the reactor via a gas inlet in the bottom of the reactor, which is located centrally below the impeller. The gas inlets are simple tubes with a diameter $d_i = 3$ or 8 mm, respectively.

In the bubble column the gas can be sparged into the liquid through several gas distributors. As gas distributors either a perforated plate with 21 holes of 0.4 mm or sintered porous plates with average pore diameters of 30 and 100 μm are used. A liquid inlet tube is installed at the top of the column just below the dispersion level, resulting in a countercurrent flow of gas and liquid through the column. As the gas distributors in the bubble column are 3.0 cm high we have subtracted 3.0 cm from the dispersion height. So all the reported specific interfacial areas and gas hold-ups are based on the true reaction volume above the gas distributor.

The gas and liquid system. A pure inert N_2 stream and an stream containing *ca* 1 vol % CO_2 are taken from high-pressure gas tanks and supplied continuously to the recycle gas flow or the bypass. The recycle gas passes through a helical mixer, is heated to the reactor inlet temperature and introduced into the reactor. The gas leaves the reactor at the top and is recycled by means of a high pressure gas booster. A separation unit is installed before the gas booster in order to separate entrained liquid droplets from the gas flow. The performance of the gas booster is controlled by means of a backpressure regulator, which

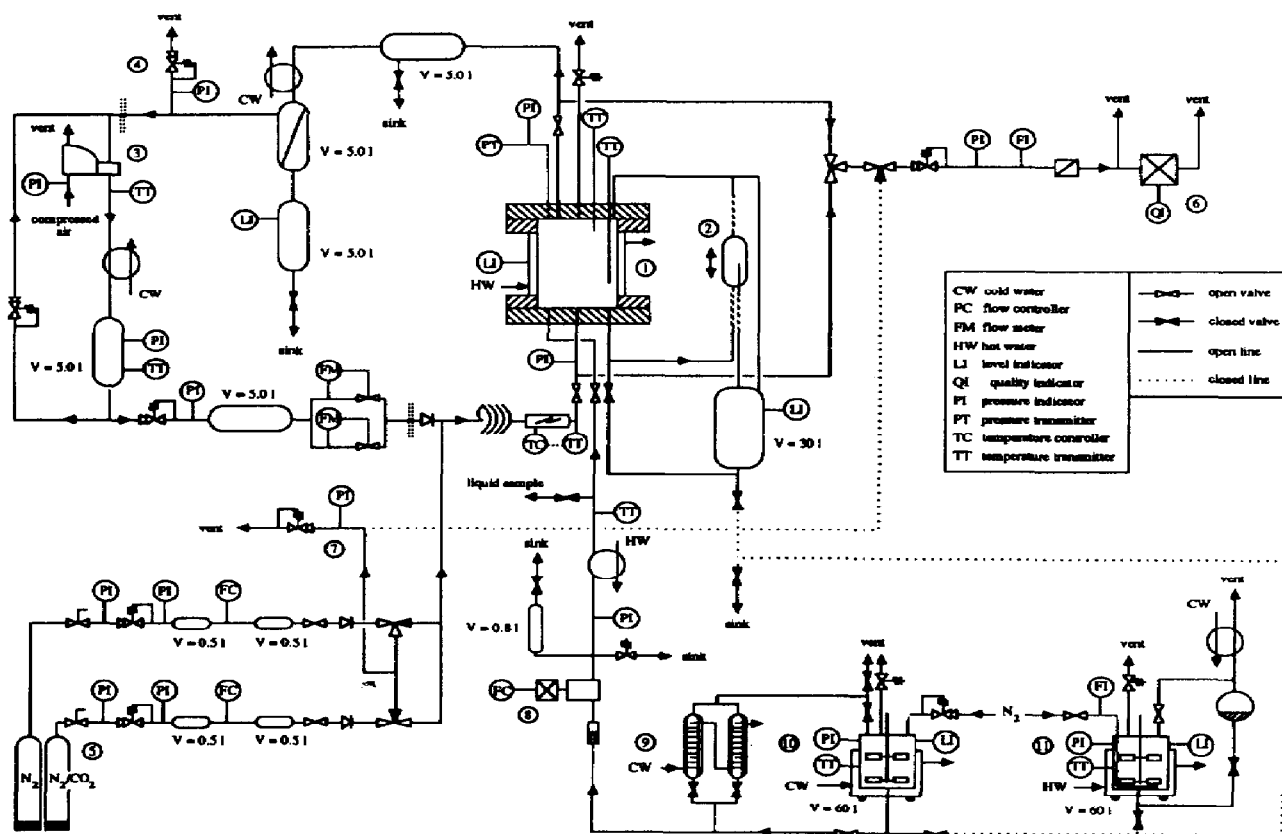

Fig. 1. Experimental installation: reactor (1), overflow vessel (2), gas booster (3), system backpressure regulator (4), gas tanks (5), infrared analyzer (6), bypass (7), liquid pump (8), liquid burettes (9), and liquid storage (10) and regeneration (11) vessels.

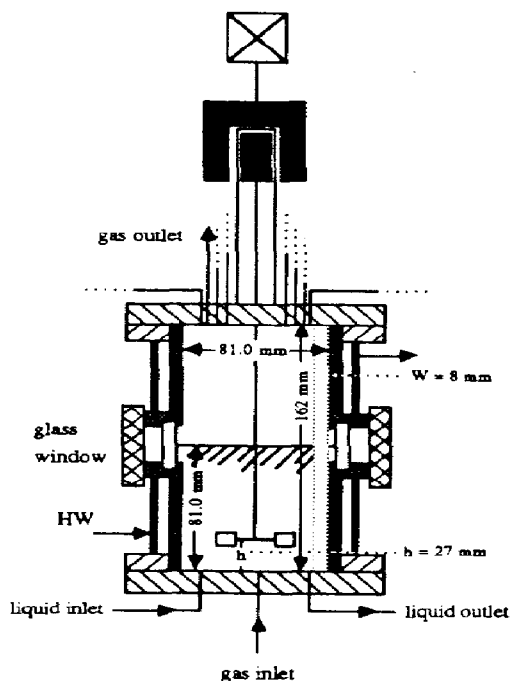

Fig. 2. Experimental mechanically agitated reactor.

regulates the output pressure of the booster and through which also a part of the gas flow, which is pressurized by the booster, is recycled around the gas booster itself. A helical heat exchanger is installed in the gas line directly behind the booster in order to prevent overheating of the gas and the booster. After pressure regulation by a pressure regulator the recycle gas flow is controlled by means of two mass flow meters each connected with a separate control valve. The recycle gas flow rate has always been kept a factor 10–20 larger than the supply gas flow rate of N_2 or N_2 - CO_2 . The system pressure is controlled by means of the backpressure regulator, which is installed in the recycle section just before the gas booster.

In order to be able to experiment over a large range of operating conditions, provisions are made to operate the installation in a conventional set-up without the gas recycle section (see the separation marks in Fig. 1). This allows for measurements at moderate pressures and thus for comparison with the results as obtained in similar gas-liquid systems and reactors by Oyevaar *et al.* (1988, 1989). On the other hand within a certain range of operating pressures and for otherwise identical conditions measurements can be performed with and without the gas recycle section.

The reactor in- and outlet gas flows are sampled continuously by switching a three-way valve. The CO_2 concentrations are determined on-line by means of an infrared gas analyzer. Including the sampling gas lines this infrared analyzer has a response time of *ca* 90 s. Due to the large volume of the entire experimental installation the response time for the CO_2

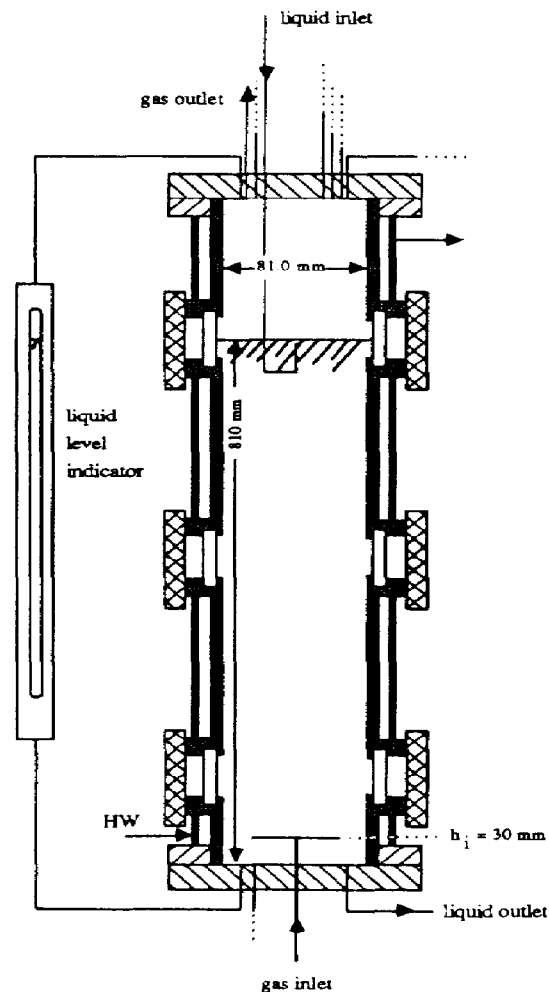

Fig. 3. Experimental bubble column reactor.

concentrations throughout the installation after a change in the operating conditions is in the range of 3000 s. The relatively short response time of the CO_2 concentration measurement therefore allows for quick determinations of the CO_2 gas phase conversions over the reactor at different operating conditions.

A fresh or regenerated DEA solution is fed from a cooled storage vessel and heated up to a temperature of 298 K before introduction into the reactor. The liquid flows through the reactor and via an overflow vessel into a liquid buffer vessel. When the buffer vessel is filled up completely, the experiments have to be stopped, and then the buffer is emptied into the regeneration vessel. The regeneration vessel with a volume if $V_L = 60$ l is kept at temperatures around 380 K and under agitation the CO_2 contained in the DEA solution is stripped continuously with N_2 . Regenerated solutions are recycled to the storage vessel and used for new absorption experiments. Liquid samples are taken to determine the DEA concentration and the CO_2 -liquid load for each fresh or regen-

erated batch of DEA solution. The DEA concentration is determined with a standard acid-base titration and the amount of absorbed CO_2 by means of the method described by Verbrugge (1979) and used by Blauwhoff *et al.* (1984).

Experimental procedure

For each new experimental series the installation is pressurized by means of N_2 and the output pressure of the gas booster and the recycle gas flow rate are regulated and controlled up to the desired setpoints. The supply gas flow rate of N_2 and the gas flow towards the infrared analyzer are regulated and controlled. The N_2 is supplied at a rate equal to the flow rate of the N_2 - CO_2 mixture as desired later on for interfacial area determinations. At the same time the N_2 - CO_2 mixture is supplied at the desired flow rate to the bypass in which the pressure is the same as in the reactor. When the pressures and gas flow rates throughout the whole experimental installation have reached their desired setpoints the liquid pump is started. For the mechanically agitated reactor and for the bubble column the DEA concentrations in the aqueous solutions are equal to *ca* 1.0 and 2.2 mol/kg, respectively [see also Oyevaar *et al.* (1988, 1989)]. The liquid flow rate is adjusted on the basis of a maximum allowable DEA conversion of 20% if all CO_2 , which is supplied to the installation, is absorbed from the gas phase. The dispersion level is regulated by means of the overflow vessel and if necessary the agitation also is started.

As the dispersion level in the reactor is stabilized the two three-way valves in the gas supply lines are switched simultaneously and instead of N_2 the N_2 - CO_2 mixture is supplied to the recycle gas flow at the desired supply gas flow rate. Directly after the switch of the three-way valves the CO_2 concentrations in the gas phase throughout the installation will increase rather sharply and part of the DEA in the solution flowing through the reactor will be converted. After a certain time, which depends on the gas and liquid flow rates, the CO_2 concentrations throughout the installation change more slowly. The determination of the CO_2 conversion over the reactor can then be started by switching the three-way valve in the gas line connected to the infrared analyzer and measuring the reactor in- and outlet gas fractions of CO_2 . A measurement in duplicate will take *ca* 5 min, after which the new operating conditions can be adjusted. In all the experiments special care is taken in order to meet the criteria for the pseudo-first-order reaction regime as given in eq. (2): the Hatta number is about 4 and at all pressures $E_{A,\infty}$ is larger than 30 [see also Oyevaar *et al.* (1988, 1989)].

RESULTS

Mechanically agitated gas-liquid reactor

Interfacial areas up to 1.2 MPa. As mentioned before Oyevaar *et al.* (1988) performed interfacial area determinations up to pressures of 2.0 MPa in a mech-

anically agitated gas-liquid reactor. In a reactor made of glass and with a diameter of $D = 88$ mm they performed measurements for superficial gas velocities between 0.25 and 2 cm/s at agitation rates of 8.3, 16.7 and 25.0 rps. They used a standard six-bladed disc turbine impeller of $D_i/D = 0.4$ and in most of their experiments the reactor was equipped with a gas inlet of $d_i = 3$ mm. The interfacial areas as determined by Oyevaar *et al.* (1988) were found to be independent of the reactor pressure.

In order to verify these findings and to extend them to a higher range of superficial gas velocities and reactor pressures we performed interfacial area determinations for the same geometry; thus with $D_i/D = 0.4$ and $d_i = 3$ mm. The results for pressures up to 1.2 MPa and for superficial gas velocities of $v_G = 1.0$, 3.0 and 5.0 cm/s are shown in Fig. 4. It can be seen that the interfacial areas for a superficial gas velocity equal to 1.0 cm/s remain constant and are independent of pressure. This is qualitatively in good agreement with the results obtained for the same operating conditions by Oyevaar *et al.* (1988). However, for a superficial gas velocity of $v_G = 3.0$ cm/s a small increase in the interfacial area with increasing reactor pressure can be observed; as can be seen in Fig. 4 this increase is even more pronounced for a superficial gas

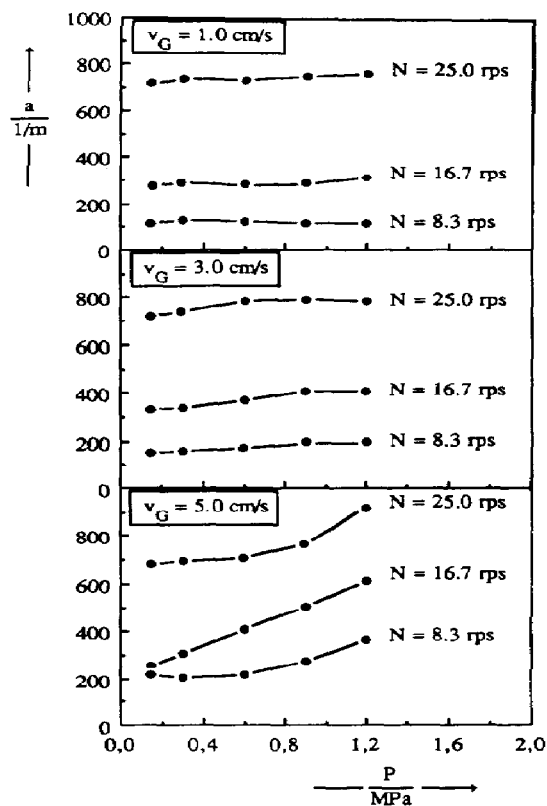

Fig. 4. Interfacial area vs reactor pressure: $D_i/D = 0.4$ and $d_i = 3$ mm.

velocity of $v_G = 5.0$ cm/s. Therefore it can be concluded that for higher superficial gas velocities and reactor pressures an influence of pressure on the interfacial area in a mechanically agitated reactor is present.

A quantitative comparison between the interfacial areas as determined by Oyevaar *et al.* (1988) for a superficial gas velocity of $v_G = 1.0$ cm/s at $N = 16.7$ rps and the interfacial areas as obtained for identical operating conditions in this study is shown in Fig. 5. Also the results obtained by Oyevaar *et al.* (1988) for a gas inlet with a porous plate of $d_i = 1.0$ cm and an average pore diameter of $30 \mu\text{m}$ are shown. It can be seen in Fig. 5 that for the identical gas inlet of $d_i = 3$ mm the interfacial areas as determined in this study are *ca* 25% smaller than those determined by Oyevaar *et al.* (1988). It should be noted that the agitation rate of $N = 16.7$ rps at which the comparison is made lies in the transition range near the critical agitation rate N_o (Westertep *et al.*, 1963), which itself is strongly affected by the reactor size especially in small reactors. The difference may also be caused by a systematic error in the determination of the dispersion level. This level is difficult to determine through the small glass windows of the reactor used in this study, while it is easier to observe through a reactor wall made entirely of glass as used by Oyevaar *et al.* (1988).

Interfacial areas up to 8.0 MPa. Interfacial areas for a superficial gas velocity of $v_G = 3.0$ cm/s as determined with a reactor geometry of $D_i/D = 0.4$ and $d_i = 3$ mm up to pressures of 6.0 MPa are shown in Fig. 6. It can be observed that the increase in the interfacial areas with increasing reactor pressure continues and can be as large as a factor of 10. For $v_G = 3.0$ cm/s, for this reactor geometry and for pressures higher than $P = 6.0$ MPa interfacial areas could not be determined due to excessive foaming of the DEA solutions. This causes difficulties in the measurement of the dispersion level and leads to large liquid entrainment.

Due to these experimental problems for the gas inlet of $d_i = 3$ mm interfacial areas could not be deter-

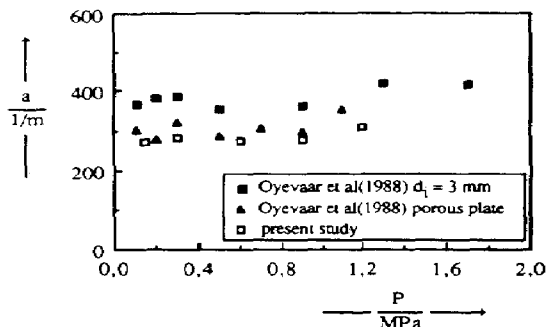

Fig. 5. Comparison between the interfacial area of the present study at $v_G = 1.0$ cm/s and $N = 16.7$ rps with those of Oyevaar *et al.* (1988); $D_i/D = 0.4$ and $d_i = 3$ mm.

mined for $\rho_G v_{G,or} > 1600$ kg/m²s. Therefore, we installed a gas inlet of $d_i = 8$ mm in which the gas velocity in the orifice $v_{G,or}$ is a factor of 7 lower. The results for this gas inlet, for pressures up to 8.0 MPa and for superficial gas velocities of $v_G = 1.0, 3.0$ and 5.0 cm/s are shown in Fig. 7: the increase in the interfacial area with increasing reactor pressure becomes considerably smaller than for the gas inlet of $d_i = 3$ mm and is never larger than 50% for all superficial gas velocities.

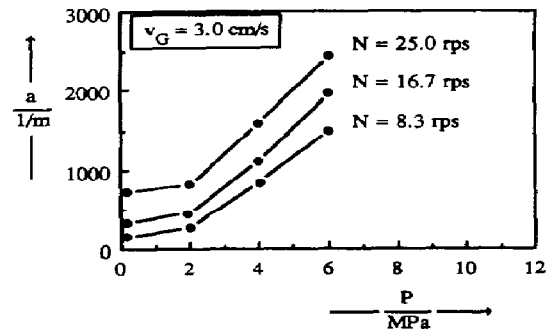

Fig. 6. Interfacial area vs reactor pressure at $v_G = 3.0$ cm/s; $D_i/D = 0.4$ and $d_i = 3$ mm.

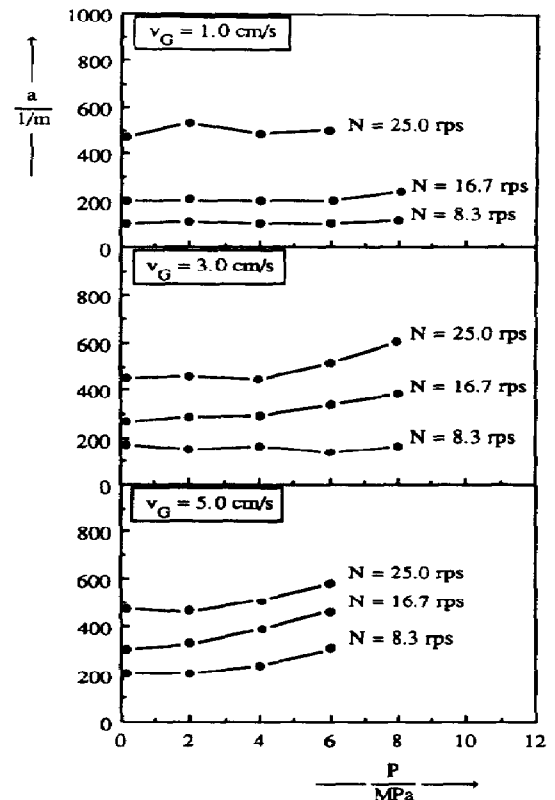

Fig. 7. Interfacial area vs reactor pressure: $D_i/D = 0.4$ and $d_i = 8$ mm.

Once again, but now for pressures up to 8.0 MPa instead of for pressures up to 1.2 MPa as in Fig. 4, it can be observed in Fig. 7 that the interfacial areas for a superficial gas velocity of $v_G = 1.0$ cm/s remain constant and are independent of pressure. For a superficial gas velocity of $v_G = 3.0$ cm/s a small increase in the interfacial area with increasing reactor pressure can be observed, which again becomes more pronounced for a superficial gas velocity of $v_G = 5.0$ cm/s: the increase in the interfacial area is larger the higher the superficial gas velocity!! Furthermore it should be noted that the increase in the interfacial area with increasing reactor pressure seems to be more or less independent of the agitation rate.

These observations indicate that the influence of pressure on the interfacial area in a mechanically agitated gas-liquid reactor is a gas inlet effect. Sridhar and Potter (1980a, b) observed in a mechanically agitated reactor with a diameter of $D = 0.13$ m an increase in the interfacial areas of as high as 75% for a pressure increase from 0.1 to 1.0 MPa. They attributed the increase in the interfacial area to the increase with pressure in the kinetic energy content of the inlet gas flow and they correlated their results by multiplying the equation of Calderbank (1958) by a factor of $(E_T/P_G)(\rho_G/\rho_{air})^{0.16}$ to

$$a = 1.44 \left[\frac{\left(\frac{P_G}{V}\right)^{0.4} \rho_L^{0.2}}{\sigma_L^{0.6}} \right] \left(\frac{v_G}{v_S}\right)^{0.5} \times \left(\frac{E_T}{P_G}\right) \left(\frac{\rho_G}{\rho_{air}}\right)^{0.16} \quad (8)$$

The part (E_T/P_G) represents the ratio of the total (kinetic and mechanical) energy supplied to the reactor and the power input by agitation only. According to the correlation of Michel and Miller (1962) as used by Sridhar and Potter (1980a, b) the power input by agitation P_G is proportional to $D_i^{5.85}$. This results in a strong decrease in the ratio (E_T/P_G) for a turbine impeller with a larger diameter D_i . The correlation of eq. (8) as presented by Sridhar and Potter (1980a, b) thus suggests that the increase in the interfacial area with increasing pressure is strongly affected by the size of the impeller, and becomes smaller for larger impeller diameters.

In order to check this for our experimental mechanically agitated reactor we performed interfacial area determinations with a turbine impeller of $D_i/D = 0.5$. Interfacial areas as determined at pressures up to 8.0 MPa with a reactor geometry of $D_i/D = 0.5$ and $d_i = 8$ mm for superficial gas velocities of $v_G = 1.0, 3.0$ and 5.0 cm/s are shown in Fig. 10. As expected the absolute values of the interfacial areas for the turbine impeller of $D_i/D = 0.5$ at a pressure of $P = 0.15$ MPa in Fig. 8 are all larger than those for identical operating conditions and for $D_i/D = 0.4$ in Fig. 7. Comparison of Figs 7 and 8 reveals furthermore that for the turbine impeller of $D_i/D = 0.5$ the relative increase in the interfacial area a_P/a_{atm} (a_{atm} = interfacial area

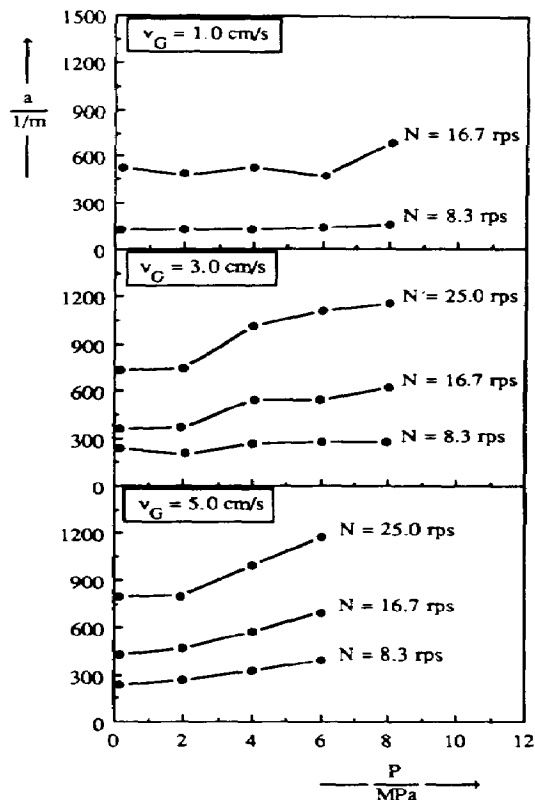

Fig. 8. Interfacial area vs reactor pressure: $D_i/D = 0.5$ and $d_i = 8$ mm.

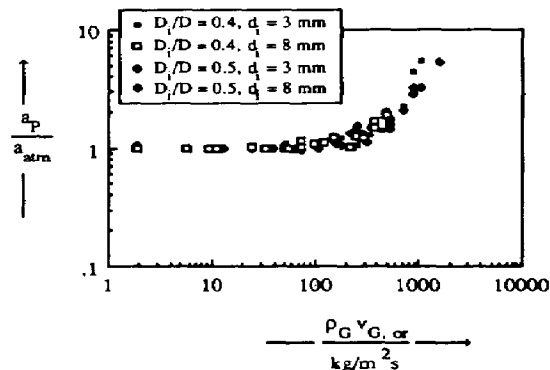

Fig. 9. Relative increase of the interfacial areas in the mechanically agitated reactor at $N = 8.3$ rps ($N < N_0$).

at $P = 0.15$ MPa) with increasing reactor pressure is quite the same as for the turbine impeller of $D_i/D = 0.4$. Except for the results for $v_G = 3.0$ and 5.0 cm/s at the highest agitation rate of $N = 25.0$ rps a_P/a_{atm} seems to be independent of the impeller diameter.

This indicates that the effect of pressure on the interfacial areas in a mechanically agitated gas-liquid reactor is not determined by the ratio (E_T/P_G) as

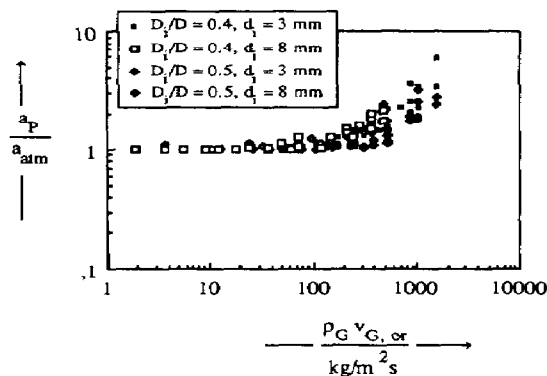

Fig. 10. Relative increase of the interfacial areas in the mechanically agitated reactor at $N = 16.7$ and 25.0 rps ($N \approx \text{or} > N_0$).

suggested by Shridhar and Potter (1980a, b), but it seems to be more an effect of pressure at the gas inlet only. Such an effect has already been observed to cause the positive influence of pressure on interfacial areas and gas hold-ups in a bubble column (Oyevaar *et al.*, (1989)).

Discussion of the results. All experimental results seem to support the conclusion that the positive influence of pressure on the interfacial areas in a mechanically agitated reactor is caused by an effect at the gas inlet:

- (1) The increase in the interfacial area with increasing reactor pressure is larger for higher superficial gas velocities.
- (2) The increase in the interfacial area with increasing reactor pressure becomes considerably smaller for the gas inlet of $d_i = 8$ mm.
- (3) The relative increase in the interfacial area a_p/a_{atm} with increasing reactor pressure is the same for agitation rates above and below the critical agitation rate N_0 .
- (4) The relative increase in the interfacial area a_p/a_{atm} with increasing reactor pressure is the same for both impellers of different diameter D_i .

The first two observations indicate that the gas velocity in the orifice of the gas inlet $v_{G,or}$ is very important for the manifestation and the magnitude of the pressure effect on the interfacial areas. The other two suggest that only a pressure effect at the gas inlet is responsible for the positive influence of pressure on the interfacial areas.

We refrained from correlating all the results by a product of dimensionless groups with their individual exponents as done by many authors [e.g. Calderbank (1958) and Sridhar and Potter (1980a, b)]. This would not only suggest a too simple mechanism for the formation of interfacial area in a mechanically agitated gas-liquid reactor, but would also imply effects of several process parameters such as ρ_L , σ_L

and μ_L , which have not been varied systematically in this study.

In order to compare the experimental results for both the impellers and both of the gas inlets we plotted the relative increase in the interfacial area a_p/a_{atm} , as obtained over a large range of reactor pressures, superficial gas velocities and agitation rates, vs the product of the gas density and the superficial gas velocity at the orifice $\rho_G v_{G,or}$. For $N = 8.3$ rps ($N < N_0$) this is shown in Fig. 9. It can be seen that a_p/a_{atm} remains constant and is unaffected by pressure for values of $\rho_G v_{G,or}$ up to $200 \text{ kg/m}^2 \text{ s}$. Increasing $\rho_G v_{G,or}$ further, either by increasing the superficial gas velocity and thus the gas velocity in the orifice of the gas inlet $v_{G,or}$ or by increasing the reactor pressure and thus the gas density ρ_G , for otherwise identical operating conditions will lead to an increase in the interfacial area at elevated pressure a_p compared to the interfacial area at atmospheric pressure a_{atm} .

The same plot as in Fig. 9 for $N = 8.3$ rps is shown for $N = 16.7$ and $N = 25.0$ rps, where $N \approx \text{or} > N_0$, in Fig. 10. Although the results for these two agitation rates are somewhat more scattered they show the same kind of dependence of a_p/a_{atm} with increasing value of $\rho_G v_{G,or}$: no influence of pressure for $\rho_G v_{G,or} < 200 \text{ kg/m}^2 \text{ s}$ and an identical increase in a_p/a_{atm} for higher values of $\rho_G v_{G,or}$.

Overall it can be concluded that a positive influence of the reactor pressure on interfacial areas in a mechanically agitated gas-liquid reactor occurs only at values of $\rho_G v_{G,or}$ higher than $200 \text{ kg/m}^2 \text{ s}$. Below this specific value of $\rho_G v_{G,or}$ no influence of pressure on the interfacial area exists. These findings are not dependent on either the agitation rate or the impeller diameter; this is in contrast to what has been observed by Sridhar and Potter (1980a, b). Earlier results for an almost identical reactor and gas-liquid system as reported by Oyevaar *et al.* (1988) did not exhibit an effect of pressure on the interfacial areas, because they have been obtained at values of $\rho_G v_{G,or}$ lower than $200 \text{ kg/m}^2 \text{ s}$.

Bubble column.

Gas hold-ups. Oyevaar and Westerterp (1989) reviewed all studies concerning the influence of pressure

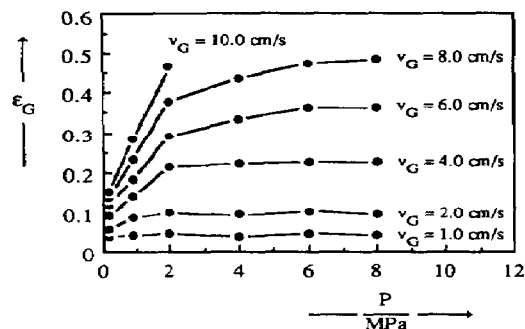

Fig. 11. Gas hold-up in water vs reactor pressure in the bubble column with the perforated plate gas distributor.

on the gas hold-up in a bubble column and concluded that the gas hold-up in a bubble column increases with increasing pressure. Their conclusion is restricted to bubble columns equipped with multi-nozzle gas distributors such as perforated plates, bubble caps and sparger rings. Studies with porous plates as gas distributors show a much smaller influence of pressure or sometimes at low superficial gas velocities no influence of pressure at all on the gas hold-ups [see also Oyeveaar and Westerterp (1989)]. As an explanation for this difference it has been suggested that gas bubbles formed at a porous plate show much interaction with each other on the surface of the porous plate, leading to coalescence of the bubbles and so to a partial or total disguise of the effect of pressure on the bubble formation process and thus on the gas hold-ups.

In order to verify these findings we performed gas hold-up measurements with three different gas distributors; a perforated plate with 21 holes of 0.4 mm and two sintered porous plates with average pore diameters of 30 and 100 μm , respectively. The gas hold-ups have been determined by means of a liquid level indicator connected to the bubble column (Fig. 3). The liquid level in this indicator under gas sparging conditions was found to be equal to the non-gassed dispersion height present in the column.

Experimental results

Results for the gas hold-ups in water, for pressures up to 8.0 MPa and for superficial gas velocities between $v_G = 1.0$ and 10.0 cm/s are shown in Figs 11–13. Pure nitrogen was used in these experiments. The gas hold-ups in the bubble column with the perforated plate are presented in Fig. 11. They show an increase with increasing pressure: this increase is larger the higher the superficial gas velocity!! Comparison of the gas hold-up differences at $P = 0.15$ and 8.0 MPa for the two superficial gas velocities of $v_G = 2.0$ and 8.0 cm/s result in relative increases of 70 and 270%, respectively. This gas velocity dependence of the magnitude of the pressure effect is in contrast with the findings of Oyeveaar *et al.* (1989), who also observed an increase in the gas hold-ups in water with increasing pressure, but this increase was not dependent on the superficial gas velocity. The difference with this study is probably caused by the small range of operating conditions ($Pv_G < 3.5$ MPa cm/s), which could be applied by Oyeveaar *et al.* (1989), while in the present study we were able to work over a much larger range of pressures and superficial gas velocities.

The increase in the gas hold-up in water with increasing pressure takes place mainly in the range of pressures between $P = 0.15$ and 2.0 MPa. For superficial gas velocities of $v_G = 1.0$, 2.0 and 4.0 cm/s a maximum in the gas hold-up is reached at $P = 2.0$ MPa; for $v_G = 6.0$ cm/s this maximum is reached at $P = 6.0$ MPa. For superficial gas velocities $v_G = 8.0$ and 10.0 cm/s a maximum in the gas hold-up cannot be determined within the pressure range ap-

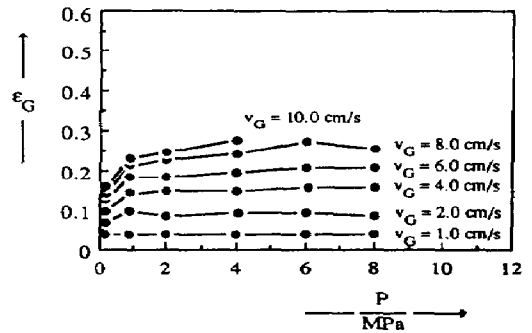

Fig. 12. Gas hold-up in water vs reactor pressure in the bubble column with the porous plate gas distributor of 30 μm .

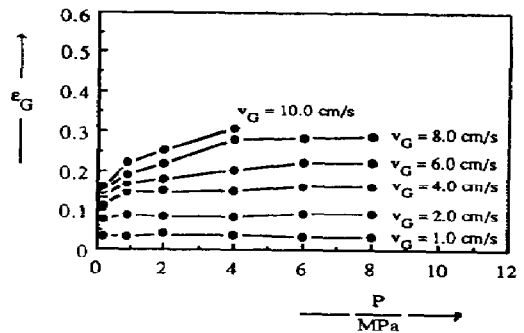

Fig. 13. Gas hold-up in water vs reactor pressure in the bubble column with the porous plate gas distributor of 100 μm .

plied. We expect that a maximum in the gas hold-up will occur at higher pressures. Qualitatively the same observations can be made in Figs 12 and 13 for the porous plates of 30 and 100 μm as gas distributors, respectively. Although an influence of pressure on the gas hold-up is present, the relative increase in the gas hold-up with increasing pressure is much smaller than for the perforated plate. The increase in the gas hold-up with increasing pressure is a factor of 3 smaller than for identical conditions with the perforated plate as gas distributor.

Oyeveaar and Westerterp (1989a) concluded that all studies claiming no influence of pressure on the gas hold-up in a bubble column have been executed at low superficial gas velocities between 0.1 and 3.5 cm/s and with porous plates gas distributors. Other studies, with different gas distributor types, always found a smaller effect of pressure when a porous plate was used. The results as obtained in this study—relatively smaller pressure effects for the porous plates and for low superficial gas velocities—are in agreement with the literature and confirm this conclusion. It can also be seen in Figs 12 and 13 that the increase in the gas hold-up with increasing pressure mainly takes place in the range of pressures from $P = 0.15$ to 2.0 MPa, and

Table 2. Literature correlations of the gas hold-ups and interfacial areas in bubble columns

$$\frac{\varepsilon_G}{(1 - \varepsilon_G)^4} = 0.20 \left[\frac{gD^2 \rho_L}{\sigma_L} \right]^{0.125} \left[\frac{gD^3}{v_L^2} \right]^{0.083} \left[\frac{v_G}{\sqrt{gD}} \right] \quad \text{Akita and Yoshida (1973)}$$

$$aD = \frac{1}{3} \left[\frac{gD^2 \rho_L}{\sigma_L} \right]^{0.50} \left[\frac{gD^3}{v_L^2} \right]^{0.10} \varepsilon_G^{1.13} \quad \text{Akita and Yoshida (1974)}$$

Akita and Yoshida investigated column diameters in the range of 0.15–0.6 m

$$\frac{\varepsilon_G}{1 - \varepsilon_G} = 1.44 v_G^{0.58} \rho_G^{0.12} \sigma_L^{-0.16} \exp(-P) \quad \text{Idogawa *et al.* (1985b)}$$

SI units except for P in MPa and σ_L in mN/m

that there is no significant difference between the gas hold-ups for the two porous plates.

Comparison with literature data

If we consider the gas hold-ups in Figs 11–13 at a pressure of $P = 0.15$ MPa it can be observed that at identical conditions the results for the porous plates and those for the perforated plate are of the same magnitude. A comparison between our data at $P = 0.15$ MPa and the relation of Akita and Yoshida (1973) is given in Fig. 14. This relation (Table 2) is recommended by Shah *et al.* (1982) and used by Oyevaar *et al.* (1989). Also additional gas hold-up measurements up to a superficial gas velocity of $v_G = 20.0$ cm/s are presented in Fig. 14. Over the whole range of superficial gas velocities and for both gas distributors the gas hold-ups as obtained in this study at $P = 0.15$ MPa agree very well with those as predicted by the correlation of Akita and Yoshida (1973).

As already mentioned before the increase in the gas hold-up with increasing pressure is smaller for the porous plates than for the perforated plate. Therefore, at higher pressures and at otherwise identical conditions the gas hold-ups for the bubble column equipped with the porous plate differ substantially from those for the perforated plate: at elevated pressures the geometry of the gas distributor has a pronounced effect on the gas hold-up in the bubble column!! Hence it is impossible to correlate the gas hold-ups at elevated pressures with one single relation for different types of gas distributor.

Idogawa *et al.* (1985b) determined at elevated pressures gas hold-ups in different liquids for a bubble column of diameter $D = 5$ cm, which was equipped with a perforated plate with 19 holes of 1 mm as the gas distributor. They worked at pressures up to 5 MPa and applied superficial gas velocities between 0.5 and 5 cm/s. They correlated their results by the correlation given in Table 2. A comparison between the experimental gas hold-ups in water for the superficial gas velocities of $v_G = 2.0$ and 8.0 cm/s for both the perforated plate and the porous plate of 100 μm with those as predicted by the relation of Idogawa *et al.* (1985b) is presented in Fig. 15. For the lower superficial gas velocity of $v_G = 2.0$ cm/s the correlation of Idogawa *et al.* (1985b) results in a too strong pressure

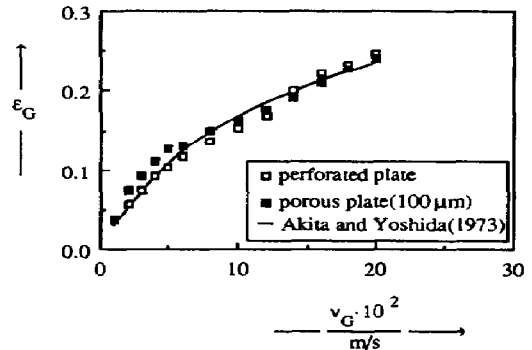

Fig. 14. Comparison between ε_G of the present study at $P = 0.15$ MPa and those predicted by the correlation of Akita and Yoshida (1973).

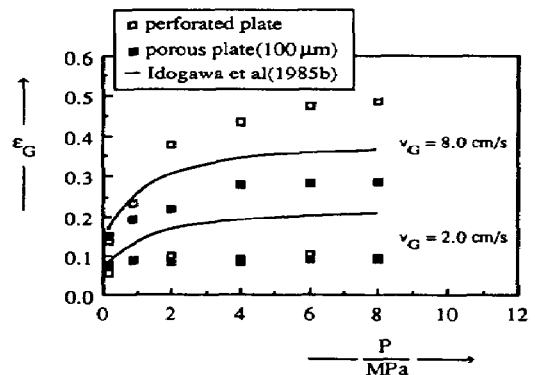

Fig. 15. Comparison between ε_G of the present study at elevated pressures and those predicted by the correlation of Idogawa *et al.* (1985b).

effect. For the higher superficial gas velocity of $v_G = 8.0$ cm/s it results in gas hold-ups at elevated pressures, which lie in between the gas hold-ups for both types of gas distributor. The agreement with the relation of Idogawa *et al.* (1985b) is bad. However, it should be noted that according to the relation of Idogawa *et al.* (1985b) the increase in the gas hold-up also mainly takes place in the range of pressures from $P = 0.15$ to 2.0 MPa.

Overall it can be concluded that the operating pressure in a bubble column has a positive effect on the gas hold-ups in water. The main increase in the gas hold-ups takes place in the range of pressures from $P = 0.15$ to 2.0 MPa. The magnitude of the pressure influence is larger for higher superficial gas velocities and is also larger if a perforated plate instead of a porous plate is used. The pressure influence on the gas hold-up in bubble columns originates from the formation of smaller bubbles at the gas distributor. These smaller bubbles have lower rising velocities, which lead to higher gas hold-ups and higher interfacial areas at constant superficial gas velocity.

Interfacial areas. For the determination of the interfacial area in the bubble column we used an aqueous solution of DEA ($c_{\text{DEA},L} = 2.2 \text{ mol/kg}$) [see also Oyevaar *et al.* (1989)]. During an absorption experiment the gas hold-up and the interfacial area could be determined simultaneously. Preliminary experiments in the aqueous solution of DEA showed a rather good agreement between the gas hold-ups and the interfacial areas in the bubble column of this study and those for identical conditions in the bubble column used by Oyevaar *et al.* (1989). However, at higher pressures ($Pv_G > 5 \text{ MPa cm/s}$) excessive foaming occurred, which led to insurmountable difficulties in the measurement of the level of the dispersion and also led to large liquid entrainment. For these conditions gas phase conversions of CO_2 higher than 0.98 occurred and in some extreme cases the outlet concentration of CO_2 could not even be determined within the experimental accuracy of the infrared gas analyzer.

In order to overcome these foaming problems we added a few droplets of oleylalcohol—an antifoam—to the aqueous solution of DEA. In doing so we were able to suppress the foaming of the solution and for all operating conditions the gas phase conversions of CO_2 appeared now to be lower than 0.98. This general decrease in the gas phase conversions of CO_2 can be explained by the activity of the antifoam, which is a surface-active agent, normally insoluble in the continuous phase and effective in very low concentrations. Near the gas-liquid interface the antifoam neutralizes the foam-stabilizing component DEA and the froth layer in the upper part of the dispersion reduces or disappears. As a consequence of the addition of the antifoam larger gas bubbles also occurred, which led to lower interfacial areas and thus to lower gas phase conversions of CO_2 .

Gas hold-ups in the aqueous solution of DEA with antifoam

As already mentioned the gas hold-ups and the interfacial areas are determined simultaneously during the absorption experiments. Results for the gas hold-ups in the aqueous solution of DEA with antifoam, for pressures up to 8.0 MPa and for superficial gas velocities between $v_G = 1.0$ and 10.0 cm/s are shown in Figs 16 and 17. Once again it can be seen

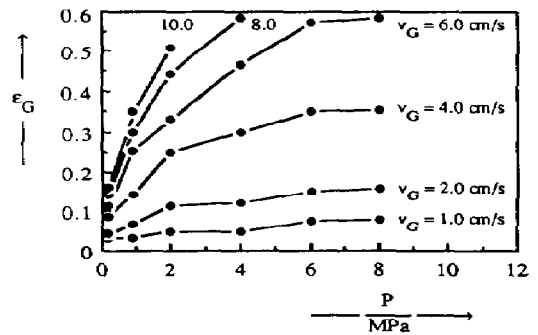

Fig. 16. Gas hold-up in the aqueous solution of DEA with antifoam vs reactor pressure in the bubble column with the perforated plate gas distributor.

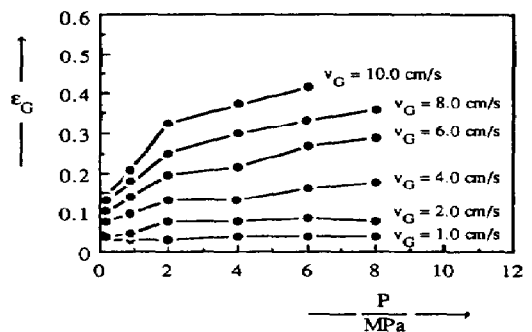

Fig. 17. Gas hold-up in the aqueous solution of DEA with antifoam vs reactor pressure in the bubble column with the porous plate gas distributor of 30 μm .

that the gas hold-ups in the bubble column increase with increasing pressure and that the pressure influence is smaller if the porous plate instead of the perforated plate is used as the gas distributor!!

Apart from the three highest superficial gas velocities of $v_G = 6.0, 8.0$ and 10.0 cm/s for the perforated plate in Fig. 16, where the hold-ups are far too high for a more or less uniform dispersion, the main increase in the gas hold-ups with increasing pressure takes place in the range of pressures between 0.15 and 2.0 MPa. This is in agreement with the results for water as the liquid phase. In contrast with the results for water at higher pressures no maximum value in the gas hold-up is reached.

Further comparison between the results in the aqueous solution of DEA with antifoam and those in water shows that the gas hold-ups in both liquids at a reactor pressure of $P = 0.15 \text{ MPa}$ and for identical superficial gas velocities are the same. However, the magnitude of the pressure effect is larger in the aqueous solution of DEA with antifoam: at elevated pressures and for otherwise identical conditions gas hold-ups in the aqueous solution of DEA with antifoam are higher than in water.

The difference in the magnitude of the pressure effect is probably caused by differences in the coales-

cence behaviour of the gas bubbles in both liquids. Water is a pure liquid and does not hinder the coalescence of the gas bubbles. However, the coalescence in aqueous solutions of DEA is affected indeed, as has already been observed in the preliminary experiments without antifoam and by Oyevaar *et al.* (1988, 1989). The addition of antifoam reduces the coalescence hinderance of gas bubbles in the aqueous solutions of DEA, but there are still ions and a second organic component present in the solution, which will affect the coalescence in the dispersion. Smaller bubbles formed at the gas distributor in the aqueous solution of DEA with antifoam will probably coalesce at a slower rate than they will in water, and the magnitude of the pressure effect on the gas hold-up will be larger than in water.

Interfacial areas in the aqueous solution of DEA with antifoam

The results of the interfacial area determinations in the aqueous solution of DEA with antifoam, for pressures up to 8.0 MPa and for superficial gas velocities between $v_G = 1.0$ and 10.0 cm/s are presented in Figs 18 and 19. As expected the reactor pressure has also a positive effect on the interfacial areas in the bubble column!! The pressure influence on the interfacial area is also smaller if the porous plate instead of the perforated plate is used as the gas distributor. Also the increase in the interfacial area with increasing pressure is larger the higher the superficial gas velocity.

However, the relative increase in the interfacial areas with increasing pressure is smaller than the relative increase in the gas hold-ups for the same pressure increase and for otherwise identical conditions. This has also been observed by Oyevaar *et al.* (1989). As the Sauter mean bubble diameter d_{mb} is related to the gas hold-up and the interfacial area according to

$$d_{mb} = \frac{6\varepsilon_G}{a} \quad (9)$$

this means that the mean bubble diameters increase with increasing pressure. However, such an increase in the mean bubble diameters should lead to lower interfacial areas, and this is in contrast with all the experimental results on a and ε_G up till now.

Oyevaar *et al.* (1989) concluded that a part of the gas hold-up does not contribute to the mass transfer of CO_2 . They attribute this to:

- (1) the formation of a froth layer in the upper part of the dispersion, which is less effective in the mass transfer of CO_2 .
- (2) the occurrence of tiny bubbles with diameters smaller than 1 mm, which accumulate in the dispersion and do not contribute to the mass transfer of CO_2 .

With the addition of antifoam to the aqueous solution

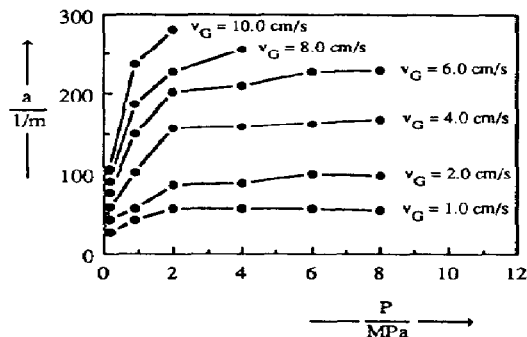

Fig. 18. Interfacial area in the aqueous solution of DEA with antifoam vs reactor pressure in the bubble column with the perforated plate gas distributor.

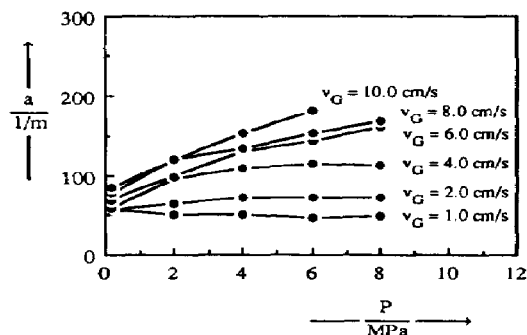

Fig. 19. Interfacial area in the aqueous solution of DEA with antifoam vs reactor pressure in the bubble column with the porous plate gas distributor of 30 μm .

of DEA in this study both the froth layer and the amount of tiny bubbles are reduced. A comparison of the mean bubble diameters, as calculated from a and ε_G for a superficial gas velocity of $v_G = 2.0$ cm/s and for the perforated plate in this study, with those of Oyevaar *et al.* (1989) for the same superficial gas velocity and for their cross-shaped gas distributor with 16 holes of 0.5 mm is shown in Fig. 20. As expected the mean bubble diameter at $P = 0.15$ MPa for this study is larger as the antifoam reduces the coalescence hinderance. It can also be seen that the increase in the mean bubble diameter d_{mb} for this study is considerably smaller: probably the froth layer and the amount of tiny bubbles are reduced. However, as the mean bubble diameter d_{mb} for this study still increases with increasing pressure it is highly probable that some froth or tiny bubbles are still present in the aqueous solution of DEA with antifoam.

Furthermore, it should be noted that at a superficial gas velocity of $v_G = 2.0$ cm/s and at atmospheric pressure the bubble column operates in the bubbly flow regime and the bubble diameters are normally in the range of 2–6 mm (Shah *et al.*, 1982). For the lowest operating pressures the mean bubble diameters, as

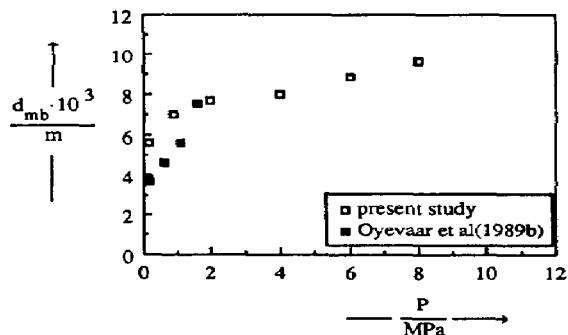

Fig. 20. Comparison between d_{mb} of the present study at $v_G = 2.0$ cm/s and for the perforated plate with those of Oyevaar *et al.* (1989).

calculated according to eq. (9) and shown in Fig. 20, are in this range. However, at higher operating pressures the calculated mean bubble diameters become larger than 6 mm. If it is further taken into account that with increasing pressure the transition from the bubbly flow towards the churn-turbulent regime occurs at higher superficial gas velocities it can be concluded that mean bubble diameters larger than 6 mm are not realistic. For higher superficial gas velocities these unrealistic mean bubble diameters are even more pronounced. Once again this indicates that in the aqueous solution of DEA with antifoam a part of the gas hold-up still does not contribute to the mass transfer of CO_2 .

Comparison with literature data

If we consider the interfacial areas at $P = 0.15$ MPa for both types of gas distributor it can be seen that the dependence of the interfacial area on the superficial gas velocity is smaller for the porous plate. For this gas distributor the interfacial areas increase from $a = 55$ to 85 m^{-1} for an increase in the superficial gas velocity from $v_G = 1.0$ to 10.0 cm/s, while the interfacial areas for the perforated plate and for identical conditions increase from $a = 26$ to 105 m^{-1} . This indicates that the dispersion for the porous plate is more uniform over the total experimental range of superficial gas velocities.

A comparison between the interfacial areas for the perforated plate at $P = 0.15$ MPa and those of Oyevaar *et al.* (1989) at the same reactor pressure is shown in Fig. 21. The interfacial areas as predicted by the relation for interfacial areas in pure liquids of Akita and Yoshida (1974) (Table 2) are also plotted. It can be observed that the addition of antifoam to the aqueous solution of DEA has a pronounced effect on the interfacial areas. It reduces the interfacial areas in the bubble column with a factor of 2–3 and leads to interfacial areas, which agree much better with those as predicted with the relation of Akita and Yoshida (1974).

DISCUSSION AND CONCLUSIONS

For the *mechanically agitated gas-liquid reactor* the results concerning the influence of pressure on the

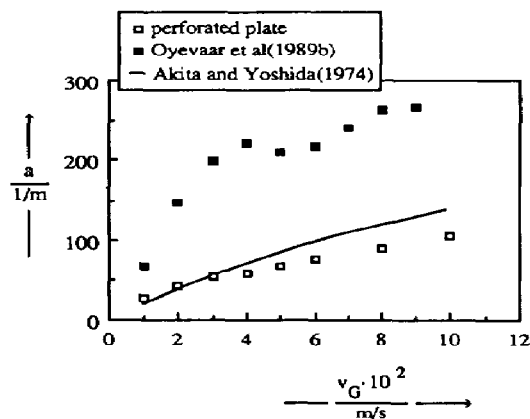

Fig. 21. Comparison between the interfacial areas of the present study at $P = 0.15$ MPa and literature data.

interfacial areas for operating conditions identical to those as used by Oyevaar *et al.* (1988) ($P \leq 1.7$ MPa and $v_G \leq 2.0$ cm/s) are the same: no influence of pressure. However, for pressures and superficial gas velocities outside this range a positive influence of pressure on the interfacial areas can be observed. For some experimental conditions—especially for higher superficial gas velocities—the reactor pressure has a considerable effect on the interfacial areas in the mechanically agitated reactor.

The pressure effect in the mechanically agitated gas-liquid reactor seems to be only a gas inlet effect and not to depend on the ratio (E_T/P_G) as suggested by Sridhar and Potter (1980a, b). The product of the gas density ρ_G and the superficial gas velocity at the orifice $v_{G,or}$ was found to be an important parameter for the manifestation of the pressure effect. For values of $\rho_G v_{G,or}$ larger than $200 \text{ kg/m}^2 \text{ s}$ the interfacial areas increase with increasing reactor pressure. Below this value no influence of pressure could be observed. Oyevaar *et al.* (1988) found no effect of pressure because they worked at values of $\rho_G v_{G,or}$ lower than $200 \text{ kg/m}^2 \text{ s}$. The relative increase in the interfacial area a_P/a_{atm} seems to be only a unique function of $\rho_G v_{G,or}$; no specific dependence of a_P/a_{atm} on the agitation rate or the size of the impeller has been observed.

For the *bubble column* the gas hold-ups increase with increasing pressure in both water and an aqueous solution of DEA with antifoam. The pressure influence on the gas hold-up originates from the formation of smaller bubbles at the gas distributor. These smaller bubbles have lower rising velocities, which lead to higher gas hold-ups and to higher interfacial areas at constant superficial gas velocity. The relative increase in the gas hold-ups is smaller in water than in the aqueous solution of DEA with antifoam and is also smaller if a porous plate instead of a perforated plate is used as the gas distributor.

The difference between the magnitude of the pressure effect on the gas hold-ups in both liquids can

be attributed to specific differences in the coalescence behaviour of the gas bubbles in both liquids. As water is a pure liquid no coalescence hinderance of the gas bubbles will occur. Contrary to water, coalescence hinderance of the gas bubbles will occur in the aqueous solution of DEA with antifoam as ions and a second organic component are present in the solution. Therefore, smaller gas bubbles formed at the gas distributor will probably coalesce at a slower rate in the aqueous solution of DEA with antifoam than they will do so in water. This will lead to a larger effect of pressure on the gas hold-ups in the aqueous solution of DEA with antifoam.

The difference between the magnitude of the pressure effect on the gas hold-ups for both types of gas distributor—either a porous plate or a perforated plate—is caused by differences in the bubble formation process at the gas distributor. The gas bubbles formed at the porous plate show much interaction with each other on the surface of the porous plate. This will lead to coalescence of the gas bubbles and reduce the effect of pressure on the bubble formation process and thus on the gas hold-ups. Generally, the increase in the gas hold-up with increasing pressure is a factor of 2–3 smaller for otherwise identical conditions if a porous plate instead of a perforated plate is used as the gas distributor.

The interfacial areas in the bubble column, as determined by means of CO₂ absorption into the aqueous solutions of DEA with antifoam, also show an increase with increasing pressure. The relative increase in the interfacial areas with increasing pressure is smaller for lower superficial gas velocities and is also smaller if a porous plate instead of a perforated plate is used as the gas distributor. The relative increase in the interfacial areas a_p/a_{atm} with increasing pressure may be as large as 200% for a pressure increase from $P = 0.15$ to 8.0 MPa, depending on the type of gas distributor and the superficial gas velocity used.

In this study we refrained from correlating our results at elevated pressures, because they are obtained in gas–liquid contactors with one diameter of $D = 81$ mm and only for water and one other particular gas–liquid system. Before these results can be correlated and applied to industrial gas–liquid contactors more research on larger gas–liquid contactors and other gas–liquid systems is necessary. Furthermore, correlating the results by a product of dimensionless groups would also imply effects of several process parameters such as ρ_L , σ_L and μ_L , which have not been varied systematically in this study.

However, the results as obtained in the mechanically agitated gas–liquid reactor as well as those in the bubble column indicate that the operating pressure in these gas–liquid contactors has a considerable effect on the interfacial area and the gas hold-up. Correlations for the interfacial areas and the gas hold-ups as determined at atmospheric pressure may therefore lead to considerable miscalculations. As the interfacial area and the gas hold-up are important design parameters for gas–liquid contactors specific atten-

tion should be paid to the effect of pressure on the interfacial area and the gas hold-up.

Acknowledgements—The investigations were supported by the Netherlands Foundation for Chemical Research with financial aid from the Netherlands Organization for the Advancement of Scientific Research. We also acknowledge A. Pleiter and his assistants for their technical support.

NOTATION

a	specific interfacial area, m ² /m ³ dispersion
c	concentration, mol/m ³
Δc	driving force for mass transfer, mol/m ³
d	diameter, m
d_i	gas inlet diameter, m
d_{mb}	Sauter mean bubble diameter, m
D	vessel diameter, m
D_A	diffusivity of component A in the liquid phase, m ² /s
D_B	diffusivity of component B in the liquid phase, m ² /s
D_i	impeller diameter, m
E_A	enhancement factor [eq. (1)]
$E_{A,\infty}$	enhancement factor for an infinitely fast reaction [eq. (4)]
E_T	total energy input into the dispersion, W
g	gravitational acceleration, m ² /s
h	impeller height, m
h_i	gas inlet height, m
H	dispersion height, m
Ha	Hatta number [eq. (3)]
k_L	liquid phase mass transfer coefficient, m/s
$k_{n,p}$	reaction rate constant for a reaction of order (n, p), m ^{3(p+n-1)} /mol ^(p+n-1) s
m	distribution coefficient ($c_L = mc_G$)
N	agitation rate, s ⁻¹
N_0	critical agitation rate, s ⁻¹
P	pressure, Pa
P_G	gassed power input, W
v	superficial velocity based on the empty cross-sectional area of the vessel, m/s
V	volume, m ³
v_S	terminal rising velocity of the gas bubbles, m/s
W	baffle width, m

Greek letters

ϵ	hold-up
ζ	conversion
μ	dynamic viscosity, N s/m ²
ν	kinematic viscosity, m ² /s
ν_B	stoichiometric coefficient of component B ($\nu_A = 1$)
ρ	density, kg/m ³
σ	surface tension, N/m
ϕ	flow rate, m ³ /s or mol/s

Subscripts/superscripts

A	component originally in the gas phase
air	air
atm	atmospheric
b	bubble

<i>B</i>	component originally in the liquid phase
free	free amine
<i>G</i>	gas
in	inlet
<i>L</i>	liquid
<i>n</i>	reaction rate order for component A in the liquid phase
or	orifice
out	outlet
<i>p</i>	reaction rate order for component B in the liquid phase
<i>P</i>	pressurized
<i>R</i>	reactor
<i>V</i>	volumetric

REFERENCES

- Akita, K. and Yoshida, F., 1973, Gas hold-up and volumetric mass transfer coefficient in bubble columns. *Ind. Engng Chem. Process Des. Dev.* **12**, 76-80.
- Akita, K. and Yoshida, F., 1974, Bubble size, interfacial area and liquid phase mass transfer coefficients in bubble columns. *Ind. Engng Chem. Process Des. Dev.* **13**, 84-91.
- Badssi, A., Bugarel, R., Blanc, C., Peytavy, J. L. and Laurent, A., 1988, Influence of pressure on the gas-liquid interfacial area and the gas-side mass transfer coefficient of a laboratory column equipped with cross-flow sieve trays. *Chem. Engng Proc.* **23**, 89-97.
- Blauwhoff, P. M. M., Versteeg, G. F. and van Swaaij, W. P. M., 1984, A study on the reaction between CO₂ and alkanolamines in aqueous solutions. *Chem. Engng. Sci.* **39**, 207-225.
- Calderbank, P. H., 1958, Physical rate processes in industrial fermentation. Part 1: the interfacial area in gas-liquid contacting with mechanical agitation. *Trans. Instn. chem. Engrs* **36**, 443-463.
- Danckwerts, P. V., 1970, *Gas-Liquid Reactions*. McGraw-Hill, London.
- Hasseni, W., Laurent, A., Midoux, N. and Charpentier, J.-C., 1987, Hydrodynamics of a trickle-bed reactor operating under pressure (0-10 MPa): flow regimes and pressure drop. *CHISA'87*, Prague.
- Idogawa, K., Ikeda, K., Fukuda, T. and Morooka, S., 1985a, Behavior of bubbles in a bubble column under high pressure for air-water system. *Kagaku kogaku Ronb.* **11**, 253-258.
- Idogawa, K., Ikeda, K., Fukuda, T. and Morooka, S., 1985b, Effects of gas and liquid properties on the behavior of bubbles in a bubble column under high pressure. *Kagaku kogaku Ronb.* **11**, 432-437.
- Michel, B. J. and Miller, S. A., 1962, Power requirements of gas-liquid agitated systems. *A.I.Ch.E. J.* **8**, 262-266.
- Oyevaar, M. H., 1989, Gas-liquid contacting at elevated pressures. Ph.D. thesis, University of Twente.
- Oyevaar, M. H., de la Rie, T., van der Sluijs, C. L. and Westerterp, K. R., 1989, Mass transfer phenomena in gas-liquid reactors at elevated pressures. Part 2: interfacial areas and gas hold-ups in two and three phase bubble column reactors. *Chem. Engng Proc.* **26**, 1-14.
- Oyevaar, M. H. and Westerterp, K. R., 1989, Mass transfer phenomena in gas-liquid reactors at elevated pressures. Part 1: state of the art. *Chem. Engng Proc.* **25**, 85-98.
- Oyevaar, M. H., Zijl, A. D. and Westerterp, K. R., 1988, Interfacial areas and gas hold-ups at elevated pressures in a mechanically agitated gas-liquid reactor. *Chem. Engng Technol.* **11**, 1-10.
- Shah, Y. T., Kelkar, B. G., Godbole, S. R. and Deckwer, W.-D., 1982, Design parameters estimations for bubble column reactors. *A.I.Ch.E. J.* **28**, 353-379.
- Sridhar, T. and Potter, O. E., 1980a, Interfacial areas in gas-liquid stirred vessels. *Chem. Engng Sci.* **35**, 683-695.
- Sridhar, T. and Potter, O. E., 1980b, Gas hold-up and bubble diameters in pressurized gas-liquid stirred vessels. *Ind. Engng Chem. Fundam.* **19**, 21-26.
- Tarmy, B. L., Chang, M., Coulaloglou, C. A. and Ponzi, P. R., 1984a, Hydrodynamic characteristics of three phase reactors. *Chem. Engng* October, 18-23.
- Tarmy, B. L., Chang, M., Coulaloglou, C. A. and Ponzi, P. R., 1984b, The three phase hydrodynamic characteristics of the EDS coal liquefaction reactors; their development and scaleup. *Instn. chem. Engrs Symp. Ser.* No. 87, 303-317.
- van Gelder, K. B. and Westerterp, K. R., 1990, Residence time distribution and hold-up in a cocurrent upflow packed bed reactor at elevated pressures. *Chem. Engng Technol.* **13**, 27-40.
- Verbrugge, P., 1979, Ph.D. thesis, University of Delft.
- Westerterp, K. R., van Dierendonck, L. L. and de Kraa, J., 1963, Interfacial areas in agitated gas-liquid contactors. *Chem. Engng Sci.* **18**, 157-176.